PCB Layer Calculation and Documentation Tool

User Guide

Speedstack

PCB Stackup Design and Documentation

Polar Instruments Ltd

Polar Instruments Ltd.
Garenne Park
St. Sampson
Guernsey
Channel Islands
GY2 4AF
ENGLAND

email: polarcare@polarinstruments.com

<https://www.polarinstruments.com>

MAN 199–2601

Speedstack User Guide

POLAR INSTRUMENTS LTD

COPYRIGHT

Copyright 2026 © by Polar Instruments Ltd. All rights reserved. This software and the accompanying documentation are the property of Polar Instruments Ltd. and licensed to the end user by Polar Instruments Ltd or its authorized agents. The use, copying, and distribution of this software is restricted by the terms of the license agreement.

Due care was exercised in the preparation of this document and accompanying software. Polar Instruments Ltd. shall not be liable for errors contained herein or for incidental or consequential damages in connection with furnishing, performance, or use of this material.

Polar Instruments Ltd makes no warranties, either expressed or implied, with respect to the software described in this manual, its quality, performance, merchantability, or fitness for any particular purpose.

DISCLAIMER

1. Disclaimer of Warranties

POLAR MAKES NO OTHER WARRANTIES, EXPRESS, IMPLIED OR STATUTORY, REGARDING PRODUCTS. ALL OTHER WARRANTIES AS TO THE QUALITY, CONDITION, MERCHANTABILITY, FITNESS FOR A PARTICULAR PURPOSE, OR NON-INFRINGEMENT ARE EXPRESSLY DISCLAIMED.

2. Limitation of Liability.

POLAR SHALL NOT BE RESPONSIBLE FOR DIRECT DAMAGES IN EXCESS OF THE PURCHASE PRICE PAID BY THE END USER OR FOR ANY SPECIAL, CONSEQUENTIAL, INCIDENTAL, OR PUNITIVE DAMAGE, INCLUDING, BUT NOT LIMITED TO, LOSS OF PROFITS OR DAMAGES TO BUSINESS OR BUSINESS RELATIONS, WHETHER OR NOT ADVISED IN ADVANCE OF THE POSSIBILITY OF SUCH DAMAGES, THE FOREGOING LIMITATIONS SHALL APPLY, NOTWITHSTANDING THE FAILURE OF ANY EXCLUSIVE REMEDIES.

TRADEMARKS

Copyright Polar Instruments Ltd. © 2026

Microsoft®, Microsoft Windows®, Windows 11® and Microsoft® Excel® are registered trademarks of Microsoft Corporation.

IBM® is the registered trademark of International Business Machines Corporation.

All other trademarks acknowledged.

Specifications

Maximum layer count	128+
Via rules	Conventional, blind and buried
Materials library	Foils, Cores, RCC foils, Non-copper cores, Prepregs,
On-line and on-premise	Solder masks, Flexible cores, Bondply, Adhesive, Coverlays, Shields, Ident inks, Peelable masks
Post press compensation	Yes (user defined)
Finished thickness compensation	Copper coverage / simple percentage
Stackup calculation	Copper thickness, stackup thickness, dielectric thickness, solder mask thickness
Drill types	Mechanical, Laser, Laser stacked, Through plated
Drill-via fill types	Copper, Resin, Solder Mask, Non-Conductive, Conductive, Sintering Paste, Copper Paste
Back drill types	Pointed, Flat, Router. Capped drills Back Drill Must Cut Layer N°, Back Drill Must Not Cut Layer N°, Back Drill Minimum / Maximum Distance from Cut Layer, Primary Drill Size
Design rules check	Design logic, symmetry, copper balance, board thickness, manufacturing tests, resin starvation
Si8000m/Si9000e integration	Bi-directional copy/paste structure parameters
Flex-rigid modelling	Mesh/crosshatch ground plane modelling in conjunction with Polar Si8000m/Si9000e
Controlled impedance structures	100+ structures supported with impedance goal seeking and structure validation
Symmetrical stacks	Structure mirroring for symmetrical stacks
Loss/Frequency dependent modelling/graphing	Differential, Odd mode, Even mode graphed over a user-specifiable frequency range
Frequency dependent calculations	Single ended: Impedance, Delay, Inductance, Capacitance, Effective Dielectric Constant, Velocity of Propagation Differential: Differential / Odd / Even / Common Mode Impedance, Odd Mode Delay, Effective Dielectric Constant, Velocity of Propagation, Near-end Crosstalk, Coupling Percentage
Causal interpolation of dielectric constant	Single frequency Er causal modelling – interpolation of Er v frequency using Svensson-Djordjevic method
Result presentation	Length of line, Inches, Metres
Display series	All Losses, Impedance Magnitude, Inductance, Resistance, Capacitance, Conductance, Alpha, Beta
Surface roughness compensation	Smooth, Hammerstad, Grosse, Gradient, Huray, Simonovich-Cannonball
File import	IPC-2581 Rev B, Ucamco Job file, Ucamco Integr8tor and Ucam (.ssx), XML STKX and SSX, Zuken CR-8000
File export	CGen Coupon Generator, CITS File, Cadence Allegro (IPC-2581 Rev B), CSV, DXF, Gerber, IPC-2581 Rev B, Mentor Graphics, v10.00, Stackup Image (JPEG, BMP, TIFF), Ucamco Integr8tor and Ucam (.ssx), XML STKX and SSX, Zuken CR-8000, Zuken DFM Center,

Personal Computer Requirements

Computer	IBM PC compatible
Processor	Pentium 1GHz or better
Operating system	Windows 11 [®] or later
Environment	Requires .NET Framework v4.8 or above
System memory required	2GB (min) 8GB recommended
Hard disk space required	200MB (min.)
Video standard	FHD (1920 x 1080*) 2 FHD (1920 x 1080*) monitors recommended
	* Note: refers to <i>effective resolution</i> (some systems automatically apply scaling to render text readable – i.e., <i>effective resolution</i> refers to the screen resolution after scaling.)
Licensing	Electronic: local FlexNet Publisher license Fixed: Parallel/USB key Floating: FlexNet Publisher license (Windows servers only)

Guide to the manual

Introduction	Introduces Polar Instruments Speedstack.
Getting started with Speedstack	Steps through the process of creating a simple stack from a set of manufacturer's data.
Configuring Speedstack	Setting up the Speedstack environment including license options, crosshatch and structure defaults, goal seeking parameters and file locations.
Using Speedstack	Discussion of the Speedstack user interface; creating and editing stackups. Using Virtual Material mode; using Material Library mode
Design rule checking	Using the Speedstack Design Rule Checker to correct stackup design errors.
Adding controlled impedance structures	Working with the Polar Si8000m/Si9000e Field Solvers to add controlled impedance structures to the stackup model. Using the goal seeking facilities of the field solver to obtain the correct impedance for a structure.
Frequency dependent calculations (Speedstack Si)	Working with frequency dependent calculations to produce graphs and tables of insertion loss v frequency for each stack substrate. Using causal modelling Using surface roughness compensation
Si Projects	Working with Si Projects in Speedstack with Si8000m and Si9000e
CITS test files	Creating CITS test files for controlled impedance structures in the stack
Speedstack Flex	Working with flex-rigid stackups – using the Speedstack Flex Navigator
Speedstack HDI	Working with HDI builds – sequential lamination
The Speedstack materials libraries	Using the Speedstack materials libraries, creating new libraries, adding material to the library. Accessing the online libraries
Printing stackup reports	Printing Speedstack technical reports; using the stack data tables, drill data tables, controlled impedance data tables, bill of materials tables and frequency dependent tables and loss graphs

Contents

Specifications	i
Personal Computer Requirements	ii
Guide to the manual	iii
Introduction to Speedstack	1
Speedstack PCB Stackup Builder	1
Speedstack PCB	1
Lossless calculations	1
Speedstack Si	1
Loss calculations	2
Frequency dependent calculations	2
Causal modelling	2
Surface roughness modelling	3
Creating CITS (Controlled Impedance Test System) files	3
Speedstack Flex	3
Speedstack HDI	3
Rapid stackup creation	4
Easy stackup editing	4
High quality documentation and file format	4
Integration with the Si8000m/Si9000e	5
Materials library	5
Online / on-premise materials libraries	5
Library filtering	5
On-premise material library	5
Speedstack's Virtual Material mode	6
Preferred builds	6
Dimensional information	6
High layer count boards	6
Supplier management	7
Original Structure Values	7
Graphical interface	7
Speedstack Navigator	7
Grid View	7
Structure View	8
Interfacing with other systems	8
Importing and exporting stackup information	8

Converting imported electrical layers to cores	8
Structure net classes	9
Installing Speedstack	10
Installing and activating Speedstack	10
Obtaining a Speedstack license	10
Uninstalling the software	10
Getting started with Speedstack	11
Online tutorial guides	11
Stackup Templates	11
Using Speedstack Stackup Builder	12
Speedstack Stackup Builder	12
The Stackup Editor	12
The Speedstack main screen	13
The Stackup Build and Construction Window	14
Changing the Stackup View	15
Panning in the stackup window	15
Structure view	16
Selecting a structure / stepping through the structures	18
Selecting structures with the structure view	18
Filtering by layer	19
Exporting the structure view	20
Grid View	21
Using Grid View	21
Recalculating the impedances	21
Using the Controlled Impedance window	22
The Speedstack menu system	22
The File menu	22
Creating new stackups and projects	22
Using the Stackup Wizard in Material Library mode	23
Using the Stackup Wizard in Virtual Material Mode	24
Specifying preferred core thickness	25
Opening projects	25
Saving stackups	25
Saving projects	25
Searching for stackups and project files	25
Supplying search criteria	26
Importing Stackup information	27
IPC-2581 Rev B	28
Setting import options	29

Setting display options	29
Sorting layer information	29
Assigning layer functions	29
Setting loss values	30
Ucamco Job Files	30
Integr8torJob files	32
XML files	32
Zuken CR-8000	32
Ucamco Integr8tor and Ucam format (.ssx)	32
Converting imported electrical layers to cores	33
Exporting stackup information	34
Exporting to Coupon Generator (CGen)	34
Export CITS File	34
Generating printed output	35
DXF, Gerber, CSV and XML files	35
Stackup images	35
Controlled Impedance Data (image)	36
Cadence Allegro (IPC-2581 Rev B)	36
Choosing export options	36
Mentor Graphics	36
Zuken CR-8000/DFM Centre	37
Ucamco Integr8tor and Ucam	37
Assigning properties to projects and stackups	38
Backing up stackups and libraries	38
Opening recent files	38
The Edit menu	39
Material Library and Virtual Material modes	39
The View menu	40
Proportional Stack Viewer	40
The Tools menu	41
The Units menu	41
External Utility	41
The Help menu	41
Configuring Speedstack	42
Environment and default settings	42
General Options	42
Structure Defaults	43
Licensing	43
Choosing default file locations	44
Specifying goal seeking parameters	44
Setting user defaults	45

Specifying default CITS test file parameters	45
CITS test methods	45
Choosing background and stackup layer colours	46
Miscellaneous Options	46
Hatch Defaults	47
Rebuild and Calculate Structures	47
Manufacturing Constraints	47
Editing and adding constraints	48
Set Target Stackup Thickness/Enable Finishing	49
Finishing Options	50
Simple Percentage Method	50
Copper Coverage method	51
Checking Copper Coverage percentage	52
Virtual Material mode	52
Working with external utilities	53
Speedstack main toolbar	54
File operations	54
Stack building operations	54
Editing the stackup	55
Copying and pasting materials	55
Changing plane types	55
Applying finishing	56
Changing the stackup view	56
Managing the materials library	56
Exchanging data with the Si8000m or Si9000e Field solver	56
Creating and editing stackups (Virtual Material mode)	57
Material Library and Virtual Material modes	57
Using the Stackup Wizard (Virtual Material mode)	57
Setting basic stack data	58
Foil and Core builds	59
Sequential HDI builds	60
Adding drills	62
Adding microvias	62
Editing the stack	64
Changing material properties	64
Choosing Symmetrical mode	65
Changing the material description	65
Changing electrical layers	66
Setting hatched planes	66
Adding controlled impedance structures	66

Calculating the structure impedance	68
Displaying more calculations	68
Goal Seeking the target impedance	69
Mirroring structures	70
Rebuilding the stack	70
Creating and editing stackups (Material Library mode)	72
Using the Stackup Wizard (Material Library Mode)	72
Electrical layer count	72
Build type	72
Choosing stackup materials	73
Adding layers	73
Nominating power planes and mixed layers	74
Adding drill information	74
Changing the stackup view	76
Filtering Materials	76
Saving stackups	76
Creating stackups manually	77
Consistency of units	77
Editing the stack	77
Adding layers to the stackup	78
Adding a core layer	79
Editing the selected layer properties	80
Adding data file names	81
Changing a layer function	81
Exchanging layers	82
Adding prepreg layers	82
Choosing the Display Data fields	83
Adding a foil layer	83
Adding solder mask layers	84
Adding the Ident layers	85
Adding notes	86
Deleting a layer	86
Copying a layer	86
Copying material properties	86
Moving materials	88
Applying finishing	88
Adding drills	89
Specifying the drill fill type	90
Adding the drill data filenames	90
Drill capping	90
Mechanical drills Drill Cap option	91

Laser drills Drill Cap option	91
Deleting drills	92
Adding stack vias	92
Via stub removal (controlled depth drilling / back drilling)	93
Specifying back drills	94
Specifying back drill information	95
Choosing a back drill type	95
Choosing back drill capping	96
Mirror Builds	98
Symmetrical Builds	99
Creating a new stack	99
Adding a prepreg layer in Symmetrical Mode	99
Adding a second prepreg layer	100
Adding foil, LPI Mask and Ident layers	101
Assigning ground planes	102
Using Ormet [®] Z-axis Interconnect	103
Adding Ormet [®] Z-Axis Interconnects	104
Design rule checking	105
Viewing design rule errors	105
Correcting design rule errors	106
Creating and using manufacturing constraints	107
Editing constraints	109
Adding controlled impedance structures	110
Shield materials and controlled impedance / insertion loss	110
Adding a controlled impedance structure	111
Choosing reference planes	113
Controlled impedance toolbar	115
Structure Browse Control	116
Calculate Displayed Structure	116
Snap Parameters and Calculate Structure	116
Displaying More Calculations	116
Changing parameter values	118
Goal seeking with Speedstack	118
Goal seeking with the Si8000m/9000e	119
Changing layer functionality	120
Switching layer types and reallocating structures	121
Increasing the layer count	125
Structure net classes	127
Original Structure Values	129
The original structure values dialog	129

Displaying the original structure values	130
Displaying original structure values in the Technical Report	130
Working with Si Projects in Speedstack and Si8000m/Si9000e	132
Si Projects	132
Transferring structures from Speedstack to the field solver	132
Adding/deleting and modifying structures	133
Frequency dependent loss calculations (Speedstack Si only)	135
Frequency dependent parameters	136
Presentation of results	137
Graph settings	137
Displaying the loss budget	139
Material and surface roughness properties	139
Dielectric loss	139
Conductor losses – surface roughness compensation	140
Surface roughness compensation methods	140
Hammerstad/Groisse/Gradient methods	141
Huray method – with Simonovich-Cannonball Model	141
Printing the technical report	143
Speedstack Si to Si9000e data transfer	144
Sharing structure properties	145
Transferring structures between Speedstack and Si9000e	147
Transferring a single structure	147
Solving for impedance	148
Running frequency dependent calculations	148
Transferring multiple structures via Si Projects	150
Modifying structures	152
Creating CITS test files	153
Exporting the CITS test file	153
Working with flex-rigid stackups	154
Speedstack Flex	154
The graphical stackup display	154
Flex-rigid stacks	154
Creating sub-stacks	155
Mesh / Crosshatch ground planes	155
Internal Coverlays	155
Definable colours per material	155
Enabling Speedstack Flex/HDI	155
Adding a flexible core	155
Using the Navigator	157

Adding stacks	157
Defining new stacks defined by layers	157
Adding a flex stack Defined by layers	158
Adding materials to the sub-stack	159
Adding a new stack by duplicating the master stack	160
Master stack	160
Enabling/disabling materials in the sub-stack	161
Copying and pasting stacks	161
Removing stacks	162
Using mini-stacks in rigid-flex constructions	162
Adding controlled impedance structures	163
Sub-stack impedance structure options	164
Aligning materials in the Navigator	165
Displaying the stack in Proportional View	166
Using the Ruler within Proportional view	167
Working with HDI builds	169
Speedstack HDI	169
Easy graphical stackup display	169
Sub-stack reordering	169
HDI builds	169
Sequential plan	169
Drill plan	169
Creating the target stack with the Stack Editor	169
Enabling/disabling materials in the sub-stack	172
Exposing the cores	174
Using the Sequential Plan	175
Using the Drill Plan	177
Exposing cores	179
Working with multiple press cycles	179
Printing the Navigator screen	180
Using Speedstack materials libraries	181
Working with the materials libraries	181
Materials library toolbar	182
Library filter toolbar	182
Opening a library	183
Opening and appending a library	183
Filtering Materials	183
Filtering for an exact match	183
Filtering with multiple criteria	184

Filtering for an inexact match with Like	184
Creating a new library	185
Loading the new library at start up	185
Importing material to the Speedstack materials library	185
Importing from local material files	185
Replacing existing material tables	186
Adding material data to an existing library	186
Adding new material to the data tables	186
Importing material to the data tables	187
Creating a new materials library table	188
Adding material data to an existing library	189
Selecting Materials from the Library	189
Arranging Columns in Library Forms	189
Locking the library	190
Using the Online Library	190
Importing from the Polar Online Library	191
Filtering libraries by frequency	191
On-Premise libraries	192
Downloadable mlbx files	192
Choosing material files	192
Using proxy servers	192
Printing stackup information	193
Speedstack Report Printer toolbar	194
Speedstack Report Printer menu system	195
File menu	195
Saving print settings	195
Loading saved print settings	195
Options menu	196
Print Setup	196
Page Setup	196
Stack Data Table	196
Stack Data Columns...	197
Show Expanded Drills	198
Controlled Impedance Data Table	199
Controlled Impedance data columns	199
Grouping structures by layer	200
Sorting impedance structures by type	201
Frequency dependent loss graphs	202
Drill DataTable	203
Showing expanded drills	203

Example 1	203
Displaying the Drill Data Table	204
Example 2	205
Displaying the Drill Data Table	206
Bill of Materials Table	207
Stock numbers	208
Choosing the bar code font	208
Choosing the start/stop character	209
Panels / Circuits per Panel...	209
Footer	210
Suppressing the footer	210
Using the expanded footer	210
Overriding the footer labels	210
Note Field Aliases	211
Print Order	211
General Options	211
Polar Logo	211
Copyright	212
Data Number Format	212
Data Alignment	212
Stack Alignment	212
Colours	212
File Path	212
Margin Guides	212
Confidential... notice	213
Speedstack Stackup XML Information (.STKX) v25.00	214
General Notes	214
Header Section	214
Stack Collection Section <StackCollection>	215
Drill Collection Section <DrillCollection>	225
Impedance Structure Collection Section <StructureCollection>	227
Impedance Structure Guidance	234
Surface Microstrip Structures	234
Coated Microstrip Structures	235
Embedded Microstrip Structures	235
Offset Stripline Structures	236
Speedstack Stackup XML Information (.SSX) v15.00	237
General Notes	237
Header Section	237
SubStack Section <SubStack>	239

Sub-stack Stack Collection Section <SubStack> <StackCollection>	241
Lower level material objects	241
Sub-stack Drill Collection Section <SubStack> <DrillCollection>	250
Impedance Structure Collection Section <SubStack> <StructureCollection>	254
Impedance Structure Guidance	260
Surface Microstrip Structures	260
Coated Microstrip Structures	261
Embedded Microstrip Structures	261
Offset Stripline Structures	262

Introduction to Speedstack

Speedstack PCB Stackup Builder

Polar Instruments Speedstack PCB Stackup Builder is designed to accelerate the PCB stack design process and deliver significant reductions in the amount of time consumed in PCB stackup documentation and control. Given designer specifications, the PCB fabricator can use the Speedstack Stackup Builder to create in just a few steps the most cost effective stack for the range of available materials.

Speedstack offers interconnect designers (PCB layout engineers), PCB front-end engineers and fabricators a fast and professional solution to layer stackup creation and documentation. Speedstack provides formal documentation for everyone involved in ensuring the correct materials are used in the build process.

Speedstack PCB

Speedstack PCB is a versatile PCB layer stackup design tool featuring powerful and easy to use graphical stackup editing capabilities. For PCB fabricators Speedstack PCB interfaces with the industry standard Polar Si8000m PCB Multiple Dielectric Controlled Impedance Field Solver.

Lossless calculations

Speedstack PCB includes a link and license for the Si8000m, using the proven Si8000m to provide the impedance data for the stack. In addition, Speedstack PCB licence holders have full access to the stand alone Si8000m Quick Solver.

Speedstack PCB is especially tailored for PCB fabricators and PCB brokers – anyone with a requirement to design or communicate controlled impedance PCB stackups.

Speedstack PCB customers are able to share stackups and read impedance requirements from designers who are using Speedstack Si PCB Insertion Loss Field Solver.

Speedstack Si

For electronic engineers involved in stackup design Speedstack Si interfaces with the Polar Si9000e PCB Insertion Loss Field Solver. Bidirectional copy and paste between Speedstack and the Si9000e insertion loss field solver allows for quick transfer of structure parameters.

Bidirectional copy and paste between Speedstack and the Si9000e insertion loss field solver allows for quick transfer of structure parameters.

Loss calculations

Speedstack Si includes a link and license for the Si9000e, using the Si9000e to provide impedance and loss data for the stack. Speedstack Si licence holders have full access to the stand alone Si9000e Quick Solver.

Frequency dependent calculations

Speedstack Si caters for frequency dependent calculations including insertion loss, which can be graphed over a user-specifiable frequency range. Frequency dependent structure properties allow for trace conductivity, frequency range and US / metric / length of line result presentation modes: Loss results are in dB/inch, dB/m or dB/LL (length of line.)

Calculations include

Single ended:

- Impedance
- Delay
- Inductance
- Capacitance
- Effective dielectric constant
- Velocity of propagation

Differential:

- Differential impedance
- Odd mode impedance
- Even mode impedance
- Common mode impedance
- Odd mode delay
- Effective dielectric constant
- Velocity of propagation
- Near end crosstalk (NEXT)
- Coupling percentage.

Calculations are included on printed technical reports which optionally also include insertion loss graphs for user-nominated structures.

Causal modelling

Frequency dependent parameters include length of line, trace conductivity, dielectric constant and loss tangent, frequencies of interest and causal extrapolation points for each substrate and also support amalgamated dielectric structures. Frequency dependent calculations employ causal interpolation of dielectric constant using Svensson-Djordjevic modelling. Library materials tables include dielectric constant

and loss tangent fields and substrate causal extrapolation reference points values may be set either manually or automatically from the library (virtual material mode supports loss tangent in laminates and soldermask.)

Surface roughness modelling

Speedstack includes surface roughness compensation in frequency dependent calculations, supporting Hammerstad, Grosse, Gradient, Huray and Simonovich-Cannonball-surface roughness modelling methods.

Creating CITS (Controlled Impedance Test System) files

Both Speedstack Si and Speedstack PCB are able directly to output controlled impedance test files (CITS) associated with each stackup for CITS controlled impedance board testing. The fabricator can link the impedance test requirements to a particular job. For the OEM this offers a clear method of sending impedance test specifications out to suppliers or brokers. Designers and fabricators can then select the best material combinations for minimising build costs. Fabricators can share their in-house material libraries with OEMs and ensure the most effective material choice is used in the build.

Speedstack Flex

Speedstack Flex allows OEM designers to create accurate and efficient flex-rigid PCB stackups in just a few minutes, with error-free documentation for tighter control over the finished board. For PCB fabricators, Speedstack Flex provides the flexibility to quickly calculate the impact of substituting alternative materials to improve manufacturability and reduce cost while maintaining the specified parameters and performance of the board. Speedstack Flex can be used in conjunction with the Si8000m and Si9000e field solvers when modelling and documenting mesh/crosshatch ground. Structure data and mesh geometry can be readily shared between Speedstack and the field solvers.

Speedstack HDI

Speedstack's Navigator quickly guides you through the sequential sub-stack lamination sequence and presents the complete assembly in a parsed graphical display that shows each phase of the multi-step lamination sequence of an HDI PCB. There is no limit to the number of press cycles that can be documented.

Resin check / excess resin algorithms determine the order in which the materials are pressed together and return useful resin percentage information that can be used to determine potential de-lamination problems.

User-definable settings within the Navigator allow engineers to display layers in transparent, invisible or 3D mode.

Speedstack HDI makes re-ordering and renaming sub-stacks quick and easy with the Navigator. This is especially useful for HDI constructions.

Rapid stackup creation

Users may specify the stackup semi-automatically with the powerful Stackup Wizard or alternatively build the stack manually, layer by layer. Speedstack is flexible and allows full manual editing of stacks created by the Stackup Wizard.

Easy stackup editing

The Speedstack offers 2D and 3D stackup view. Layer and material annotation is clear and easy to read; each layer may be selected and queried to display the associated material type and properties, including the associated data file. Visible drill information ensures that designers instantly know which layers support conventional, blind and buried vias.

Speedstack allows you rapidly to build and share stacks and verify via aspect ratios and track spacing rules. The stack file contains base material information – with layer description and a list of all transmission line structures deployed in the stack. Keeping all stack information in one file ensures that manufacturing data is accurately shared between original designer and fabricator.

Speedstack's Stack Editor provides efficient and time-saving features such as Copy/Paste Material properties so the stack designer can copy all properties from a selected material and then paste user-selectable property groups to other materials.

Speedstack allows the designer to retain and re-allocate structures when changes are made to the electrical layers of the stackup. This enables reallocation of structures after the following stackup changes:

- Adding and deleting foils and/or cores – increasing or reducing the layer count

- Moving foils and cores – maintaining the layer count

- Exchanging two different thickness cores within the stack

- Copying/pasting foils or cores – increasing the layer count

High quality documentation and file format

Speedstack saves the stack in efficient electronic format and outputs stack graphics in formats to suit your requirements. Stack data may be output in GERBER, DXF, BMP, JPEG, TIFF and XML. Stack data can also be exported in comma-separated form for inclusion in other systems. Speedstack's high quality customisable printouts make it easy to discuss alternate builds and pricing impacts with fabricators.

Applications engineers, front end and production engineers benefit from receiving stack information in an intuitive, easy to understand format. The Speedstack .sci file contains full details of the layer stackup of a particular job. If changes are necessary or preferred stacks are to be shared with customers, Speedstack can cut the time for documentation and information sharing to a fraction of the time taken when employing traditional methods such as spreadsheet, word processor or presentation software.

Integration with the Si8000m/Si9000e

Speedstack is fully integrated with the Polar Si8000m Controlled Impedance and the Si9000e PCB Transmission Line Field Solvers so the user can quickly add controlled impedance structures to layers in the stackup. The designer or board fabricator can use the Goal Seek facility of the Si8000m/Si9000e field solvers to arrive rapidly at the controlled impedance structure parameters to produce the target impedance.

Materials library

Speedstack supports a flexible materials library. This allows the designer to use standard materials data and also provides the facility to create new material libraries. PCB fabricators can also build libraries of commonly stocked materials to give interconnect designers visibility of the materials held in stock. Speedstack thus supports three types of library – custom user libraries of materials, generic designer libraries of materials of given dielectric characteristics (for example, thicknesses) along with a comprehensive set of materials libraries from PCB base material suppliers who are members of the Polar Speedstack Material Partner program.

Online / on-premise materials libraries

The Speedstack Material Library includes an online library to allow users to download material library MLBX files from the Polar website. The online material library feature provides the user with a list of available library files from suppliers in the Speedstack Material Library Partner program.

Library filtering

Materials can be filtered by supplier and by the frequency at which the dielectric constant and loss tangent (Dk and Df) are specified. On selection the file is downloaded and is either appended to the existing data or replaces the existing data.

On-premise material library

Speedstack also includes an *on-premise* option to allow the complete online library to be downloaded to a local folder for

on-premise access; customers on Polarcare support who cannot connect to the online library due to network security restrictions can request a copy of the most recent library; contact polarcare@polarinstruments.com with your Polarcare contract number to obtain the latest material library.

Speedstack's Virtual Material mode

Speedstack provides *Virtual Material* mode, allowing you to build and experiment with stackups (for example, to examine the effects on impedance structures of different trace widths or dielectric heights) without requiring real materials to be entered into a materials library.

In Virtual Material mode you will use the Stackup Wizard to enter a few details about the stack, the number of layers, overall board thickness, plane and mixed layers, etc., along with solder mask and copper thickness and build type (foil, core or HDI) and drills.

Speedstack will then build a stack to the specified board thickness by equally distributing the dielectric regions. If a preferred core thickness is specified the software will maintain the dielectric thickness for core regions but then equally distribute prepreg regions to reach the target board thickness.

Preferred builds

PCB fabricators are able to create and share preferred builds and exchange the associated information with designers. Build data also includes blind and buried via specification. This simplifies the task of sharing stackup and drilling information between board shops and the design community.

Dimensional information

Finished board thickness is a critical dimension in many applications; Speedstack keeps track of the finished PCB thickness and tolerance and allows fabricators the flexibility of adding in-house post-press thickness for prepreg layers. Additionally, Speedstack takes into account plating thickness where appropriate.

High layer count boards

On boards with high layer counts it can be very easy to make a change that would produce a non-symmetrical stack. The Speedstack Design Rules Check monitors symmetry across the stack, and ensures that material symmetry is maintained. Speedstack also makes it easy to set the symmetrical build mode to ensure that any changes you make are applied equally across the stack.

Supplier management

When multiple-sourcing PCBs or when moving from prototype to volume production, the stack and fabrication design rule checks ensure that the manufacturing capabilities of your chosen suppliers are not overlooked. In addition, the professional documentation output ensures that layer stack information is accurately conveyed to PCB suppliers.

Original Structure Values

When a stackup design arrives for fabrication, the requested structure trace widths and separation values often have to be adjusted, on a per structure basis, by the fabricator.

Speedstack's Original Structure Values feature ensures that the requested parameter values (the original trace width and separation values) as specified by the designer are retained.

Graphical interface

Speedstack offers an easy to interpret graphical interface. Clearly showing the layers supporting blind and buried vias, Speedstack also records the data file for each layer (including ident and peelable mask layers). The graphical interface is especially designed to simplify the process of communication between interconnect designer and fabricator. OEMs who need to manage boards sourced from multiple suppliers will also find this facility invaluable. In addition to physical layers Speedstack adds mask and notation for electrical layers.

Speedstack Navigator

The Speedstack Navigator provides a clear contextual view of the rigid and flexible stacks within a flex-rigid build and allows easy alignment of displayed materials between stacks. The associated technical report also supports different materials on the same dielectric layer, improving the clarity of documentation between the stackup designer and the fabricator.

Grid View

Speedstack's Grid View provides a single grid-based dialog where all materials can be edited from the same screen. This allows the user rapidly to change the properties of multiple materials and apply all the changes simultaneously. Editable fields include Layer Name, Description, Dielectric Constant, Loss Tangent, Processed Thickness and Copper Coverage.

The tabular data in Grid view can be exported to Microsoft® Excel® for editing and the edited version imported from Microsoft Excel into Grid View. Changes made in Grid View are reflected in the main Stackup Editor and can be saved back to the original stackup design.

Structure View

Structure View presents an interactive overview of the controlled impedance / insertion loss structures that exist on the stack up, offering enhanced visibility of all impedance structures from the main edit view. Positioned to the right of the stack up within the Stack Editor window, structures are aligned with the stackup electrical layers on which they have been defined.

Interfacing with other systems

Speedstack is able to load an XML file on launch. If an XML file (.stkx) filename parameter is specified on the command line it will import this file into Speedstack.

Speedstack can call an external program / utility / script via the External Utilities menu options. The menu items are configured within the Configuration option.

Importing and exporting stackup information

IPC-2581 Rev B

Speedstack incorporates Import from and Export to IPC-2581 Rev B option with interactive interface, supporting stackup material and structure information

Ucamco

Speedstack incorporates the facility to read in files in XML format and Ucamco Job File format, providing comprehensive integration with Ucamco and will import files from and export to both Ucam and Integr8tor.

Zuken

Speedstack integrates directly with the Zuken CR-8000 Design Force and Zuken Design Force DFM Center PCB manufacturing pre-processing and CAM system, simplifying material communication in the supply chain. Designers can define layers in DFM Center then export to Speedstack to define materials and provide a fully documented stackup in a format widely recognised by both PCB supply chain managers and fabricators.

Stacks may be exported to the Polar CGen Coupon Generator for subsequent processing into test coupons. The Export CITS File option will create test files for Polar CITS controlled impedance test systems. Speedstack can generate printed output in DXF, Gerber, CSV and XML, as well as graphic image formats JPEG, BMP and TIFF.

Export options also include Cadence Allegro, CSV, IPC-2581 Rev B and Mentor Graphics. Import / export XML file formats support frequency dependent structure properties.

Converting imported electrical layers to cores

When importing stackup data from some CAD / CAM systems only the electrical layers are defined, so copper

layers may appear adjacent each other. Speedstack allows conversion of two adjacent electrical layers into core or flexible core materials using the Convert to Core function.

Structure net classes

Speedstack is able to import and store up to five net class names with each structure. These net class names provide a link to the matching impedance nets inside the ECAD PCB layout system.

Installing Speedstack

Installing and activating Speedstack

It will be necessary to install and activate the product license and set operating options prior to building stacks or performing calculations with Speedstack.

See *Configuring Speedstack|Licensing* to select the associated field solver and purchased options.

Obtaining a Speedstack license

Speedstack is license using the FlexNet Publisher licensing service. Contact Polarcare@polarinstruments.com for installation/activation directions.

Download the software from the supplied link. Unpack and save the installation file to a suitable folder then run Setup.

Uninstalling the software

Caution: Prior to uninstalling, make a copy of the Speedstack folder structure and data files and store in a safe place.

To uninstall the Speedstack software:

Windows 7/8

Choose Settings|Control Panel; select Programs and Features and right click Speedstack and choose Uninstall.

Windows 10/11

Click The Windows Settings Icon and Choose Apps.

From The List of Apps And Features click Speedstack then click Uninstall

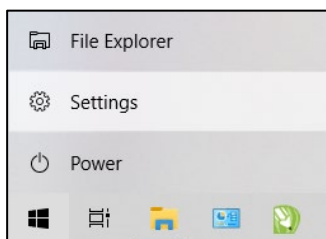

Getting started with Speedstack

Online tutorial guides

Polar's web site provides online downloadable quick start and version specific user guides to familiarize users with the operation and features of the software.

From the Help menu choose Speedstack Help to download the Getting Started guide, along with tutorials for stack editing, managing materials libraries, manufacturing constraints and controlled impedance structures:

<https://www.polarinstruments.com/help/speedstack/tutorials/>

Download the user guide for your Speedstack version:

<https://www.polarinstruments.com/help/speedstack/Nrmstart.htm>

Stackup Templates

Polar's web site provides online downloadable prebuilt sample templates and associated technical reports (suitable for Speedstack 2019 or higher) to familiarize users with the operation and features of the software.

<https://www.polarinstruments.com/support/stackup/templates.html>

The stackup templates listed include both materials and drills and are typical of standard stacks used in PCB construction and can prove useful as a starting point when building your own stacks.

Stackup samples include core and foil build models in both material library and virtual library modes (see *Creating and editing stackups*) for rigid stackups, flex-rigid stackups and multiple press cycle HDI stackups.

Click on the link above or on the Polar web site navigation bar click Resources|Stackup Templates and download the Speedstack template project (.sci) file; save to a convenient location and then use the Open Project command in Speedstack to view and edit the stackup.

Note that the sample stackups are shown with dimensions in microns.

Using Speedstack Stackup Builder

Speedstack Stackup Builder

Double-click the Speedstack icon to start the Speedstack program and display the Stackup Editor.

The Stackup Editor

The Speedstack Stackup Editor screen displays all details of the stack, including copper and prepreg materials, solder masks and ident layers, drilling information, controlled impedance structures and design rule check results.

Controlled impedance structure data may be transferred between Speedstack and the associated Polar Si8000m or Si9000e field solver to goal seek for the target structure dimensions.

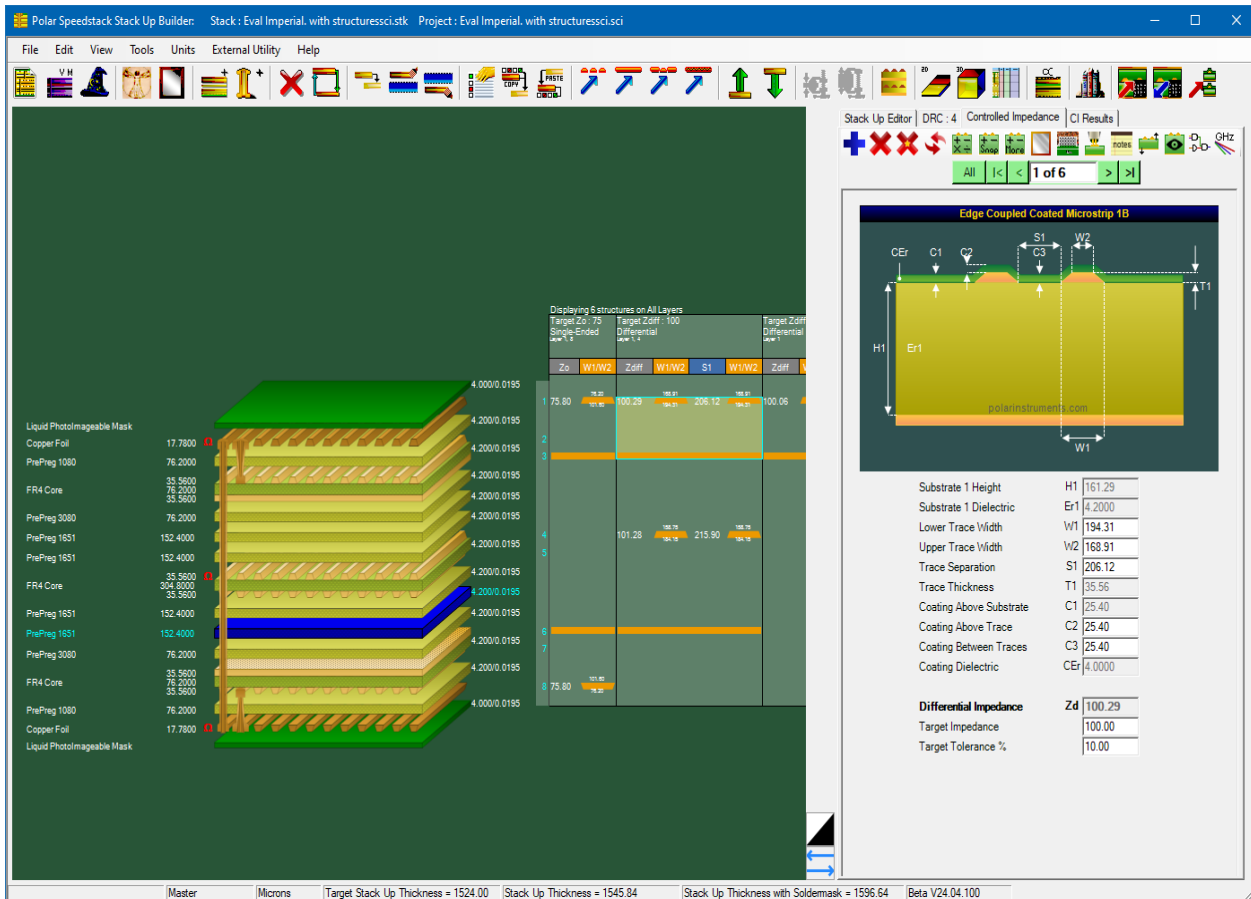

Speedstack main screen

The Speedstack main screen

The Speedstack main screen comprises:

- The Stackup Build and Construction Window — where the board stackup is built and edited. Materials from an extensive library of cores, prepregs, foils, solder masks, bondply, adhesives and shields supplied by manufacturers in the Speedstack Material Partners program are added to the stackup in the Stackup Editor. The Stackup Build and Construction Window includes Structure View which presents an interactive overview of the controlled impedance / insertion loss structures that exist on the stackup, offering enhanced visibility of all impedance structures from the main edit view. Positioned to the right of the stackup within the Stack Editor window, in 2D view structures are aligned with the stackup electrical layers on which they have been defined.
- The Grid View Window — provides a single grid based dialog view of the stack where all materials' descriptions can be edited from the same screen.
- The Controlled Impedance window displaying the controlled impedance structures (if any) for the selected layer. Structures may be added or deleted and recalculated after editing. The Controlled Impedance window also contains a Mirror Structures function for a symmetrical stack and a Goal Seek function which will adjust the structure's trace widths for a target impedance.
- Stackup Editor/Notes tab — a free form text area for explanatory or commentary notes
- Design Rules Check (DRC) tab — allows design rules and manufacturing constraints to be specified and violations displayed
- Stackup Information properties area — table containing information related to the whole stackup
- Selected Item Information area — properties table containing the attributes of the layer currently selected in the stackup
- The Controlled Impedance Results tab – summarizing the controlled impedance structures within the stack
- The Menu bar — drop-down context sensitive menus containing all the Speedstack Editor commands
- The Tool bar — incorporating short cut tool buttons to the most common menu commands

The Stackup Build and Construction Window

The Stackup Build and Construction Window is where the board stackup is built and edited. New stacks are created and existing stacks edited in this window. Stacks are portrayed as a not-to-scale pictorial representation of the sequence of materials in the stackup.

Materials from the Speedstack library of products, an extensive library of cores, prepregs, foils, solder masks, bondply, adhesives and shields supplied by manufacturers in the Speedstack Material Partners program, are added and arranged in the stack via the Build and Construction Window.

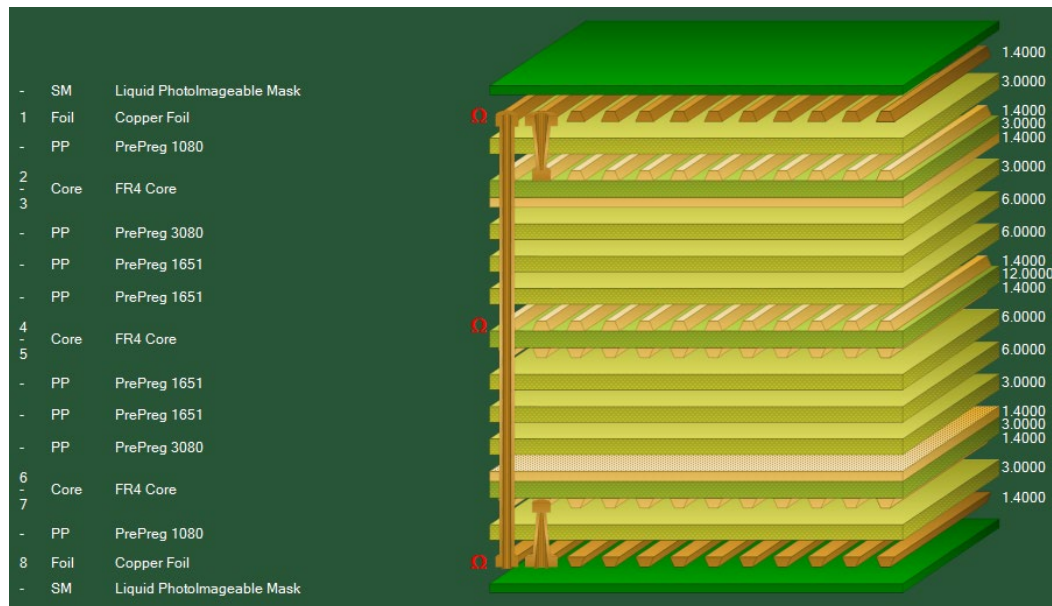

Speedstack PCB Build and Construction Window allows the OEM designer rapid creation of accurate and efficient rigid and flex-rigid PCB stackups, and provides error-free documentation for tighter control over the finished board.

The interactive graphical interface also provides the PCB fabricator the flexibility to quickly calculate the effect of substituting alternative materials within the stack to improve manufacturability and reduce cost while maintaining the specified parameters and performance of the board.

Speedstack Si Build and Construction Window is ideal for the designer, fabricator or PCB technologist who needs to manage PCB stackups with both impedance and insertion loss control. In addition to incorporating Polar's proven insertion loss field solver capability, Speedstack Si allows rapid import and export of insertion loss projects into the Si9000e Insertion Loss Field Solver so you can analyse your stack up design in detail.

Changing the Stackup View

The Stackup Window provides a full representative non-scale view of the stackup and, optionally, all the controlled impedance and insertion loss structures in the stack.

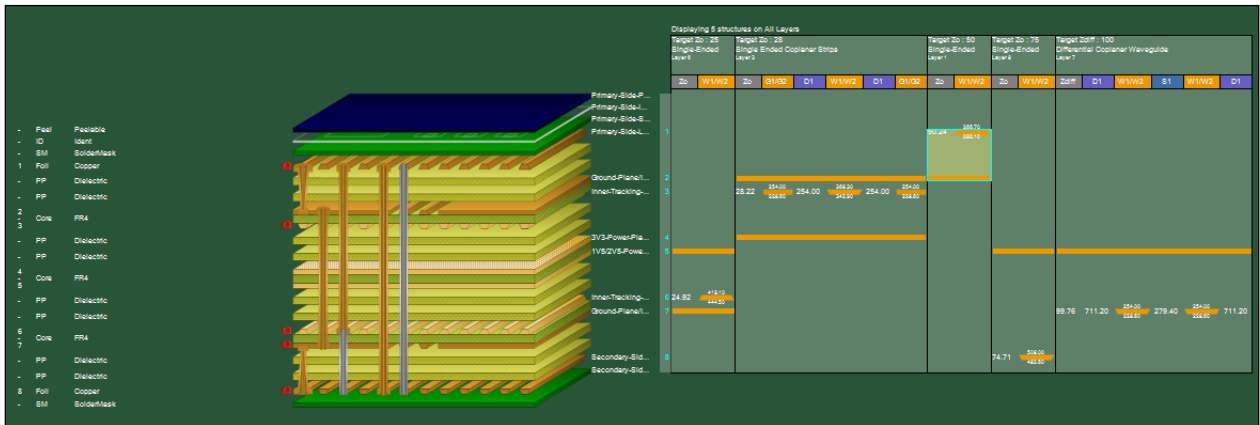

The view above presents the combined Stackup View and Structure View – the labelled stackup and all its controlled impedance and insertion loss structures,

The View menu allows for zooming in for a detailed view of sections of the stack. Use the Zoom In (Ctrl & +Key) command to focus on the section of interest. Zoom in and out of the view with the mouse wheel.

Panning in the stackup window

Use the mouse drag and drop to pan horizontally across the stackup editor window.

Vertical panning is enabled when the height of the displayed stackup exceeds the height of the Editor window

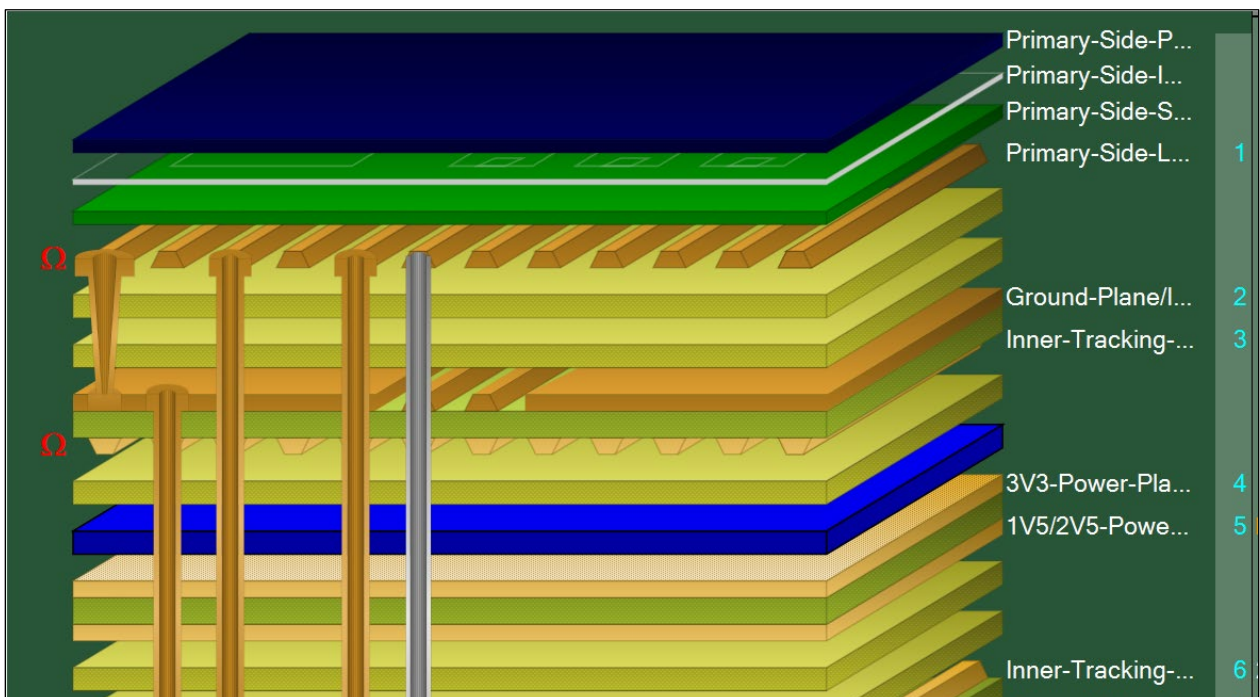

Click into the stackup and drag it up and down into position.

Structure view

Structure View presents an optional interactive overview of all the controlled impedance and insertion loss structures that exist on the stack, offering enhanced visibility of all impedance structures from the main edit view. To access Structure View drag the stackup to the left or use the Show / Hide Structure View button. Structure View is positioned to the right of the stackup within the Stackup Editor.



Show / Hide Structure View

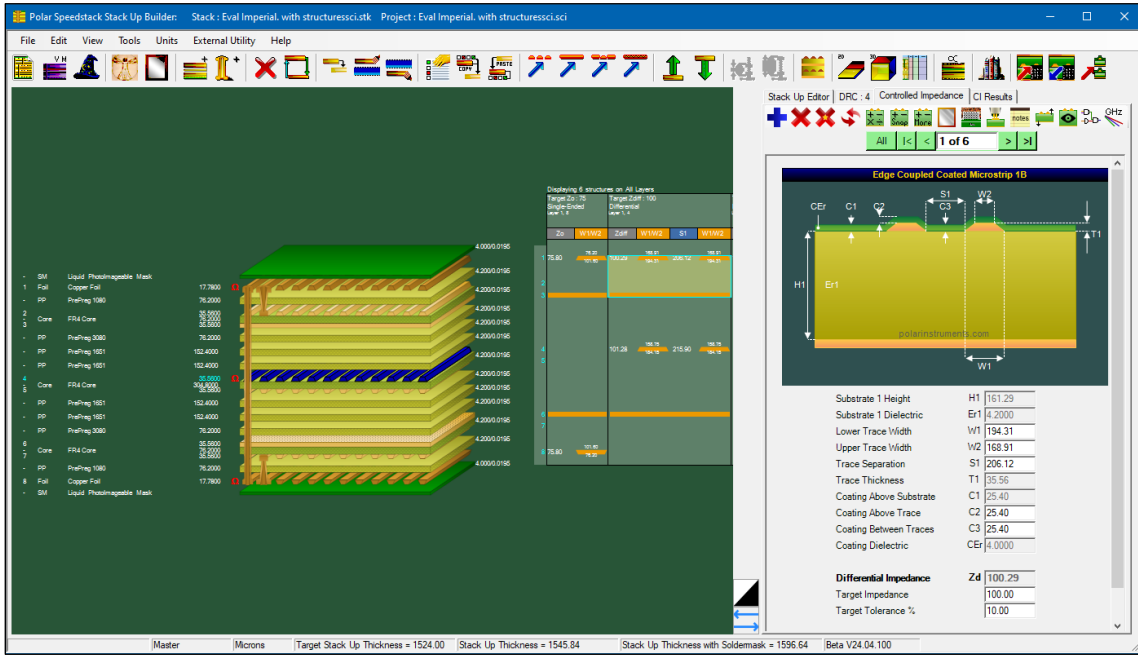

Structure View – 3D View



2D View

Click the 2D View icon. In 2D view, structures are aligned with the stackup electrical layers on which they have been defined – see below.

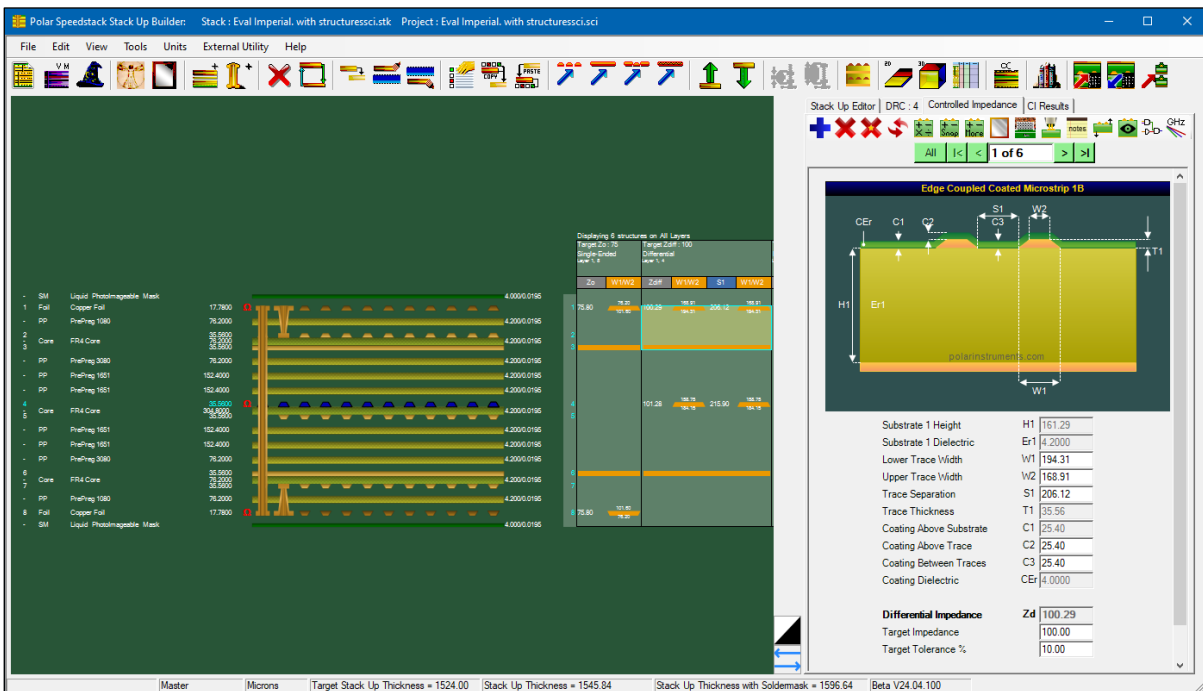

Structure View – 2D View

Click Zoom Extents from the View menu and drag the stackup so that the stackup and structure view are both displayed in the Stackup Editor window



Structures are arranged left to right in ascending order of Target Impedance, (in the stackup above, 50Ω then 75Ω then 100Ω) then by Structure Type.

All structures of the same Target Impedance and Structure Type will be positioned in the same column

In this example there are two 50Ω structures in Column 1, two 75 Ω structures in Column 2 and three 100Ω structures in Column 3

The column header contains the Target Impedance, Structure Type and the stackup layers containing the structures.

Target Zo : 50 Single-Ended Layer 1, 8		Target Zo : 75 Single-Ended Layer 1, 8		Target Zdiff : 100 Differential Layer 1, 4, 8			
Zo	W1/W2	Zo	W1/W2	Zdiff	W1/W2	S1	W1/W2

The Column Cell displays the structure's calculated impedance and Lower / Upper Trace Widths (W1 / W2) and Trace Separation (S1).

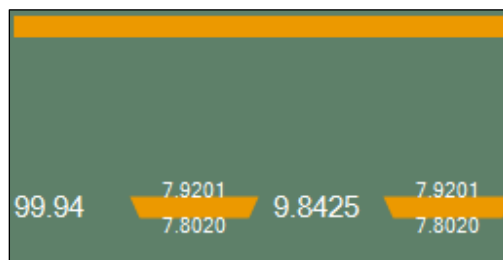

Selecting a structure / stepping through the structures

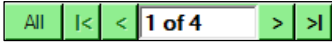

Structure Browse Control

Use the Structure Browse Control to select a structure or step through the structures. In the graphic below the first structure is displayed.

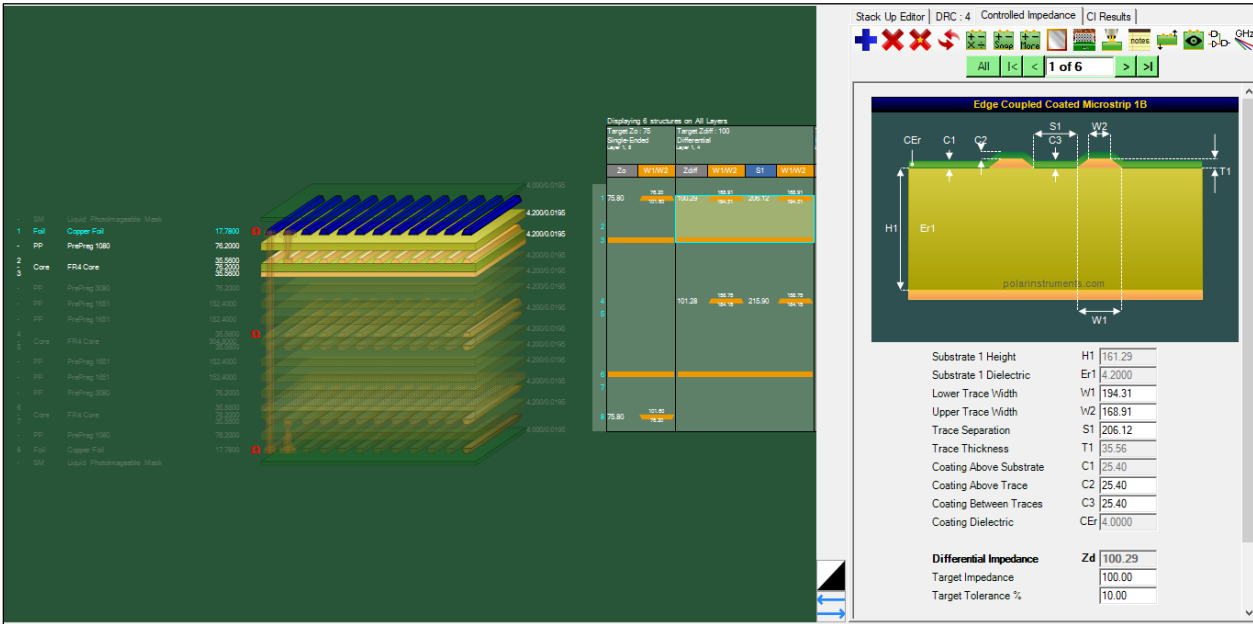

Use the Structure Browse Control arrow keys to step through the structures.

Selecting structures with the structure view

To select a specific structure within the structure view, click on the structure trace within the column cell. The structure is selected in the structure view (shown highlighted in blue) and the stackup and the Controlled Impedance tab.

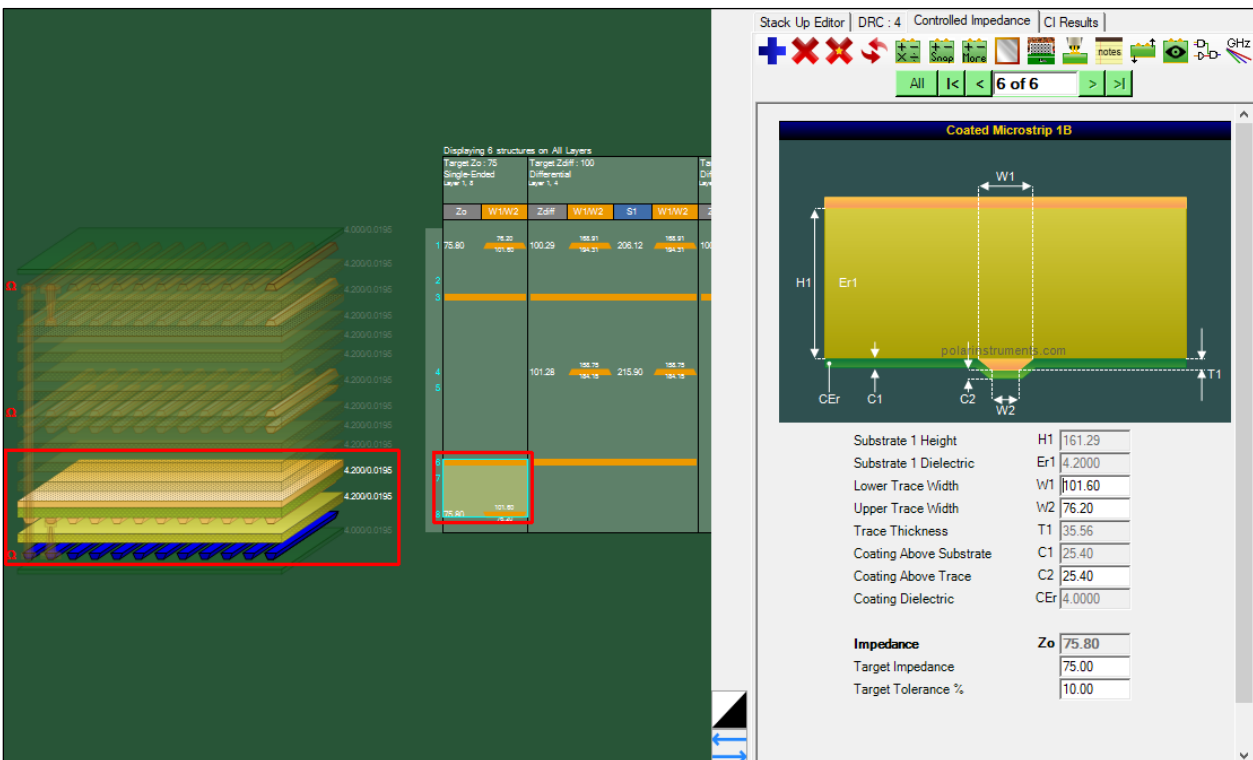

Filtering by layer

Speedstack can display all the layers and structures within the stack or just the structures on a layer of interest.

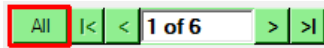

Filter by Layer button

The graphic below shows all layers and structures as indicated by the Filter by Layer button on the Structure Browse control.

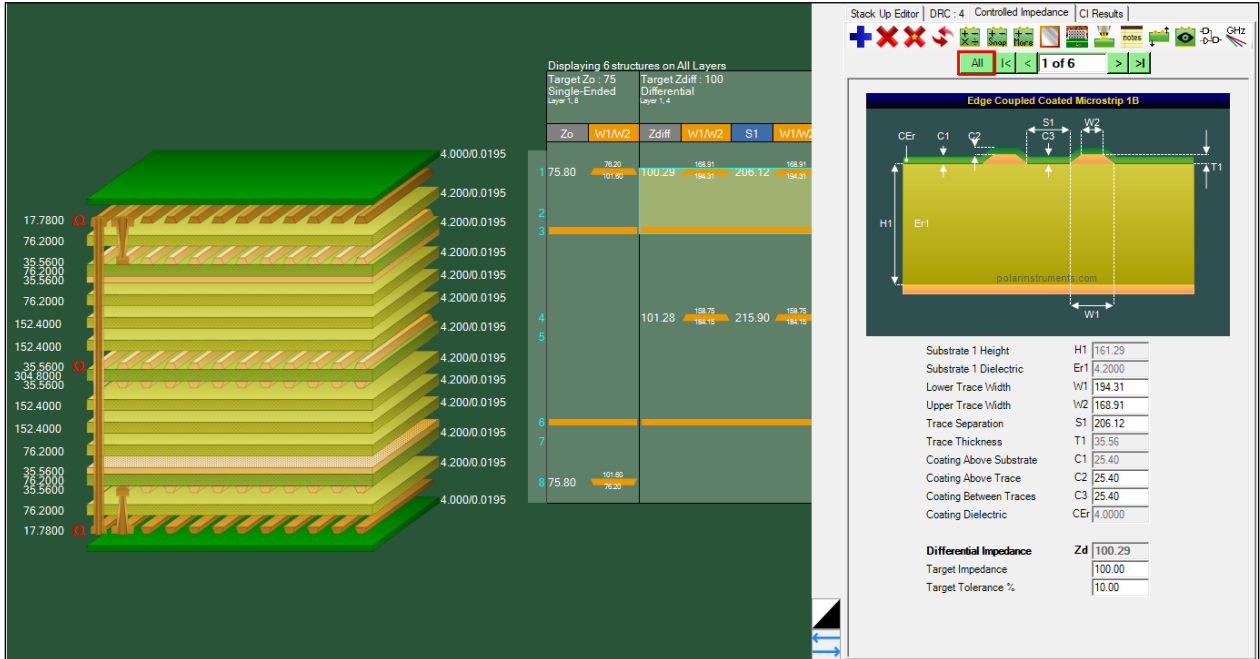

To display just the layer of interest click the layer in the stackup and click the Filter by Layer button

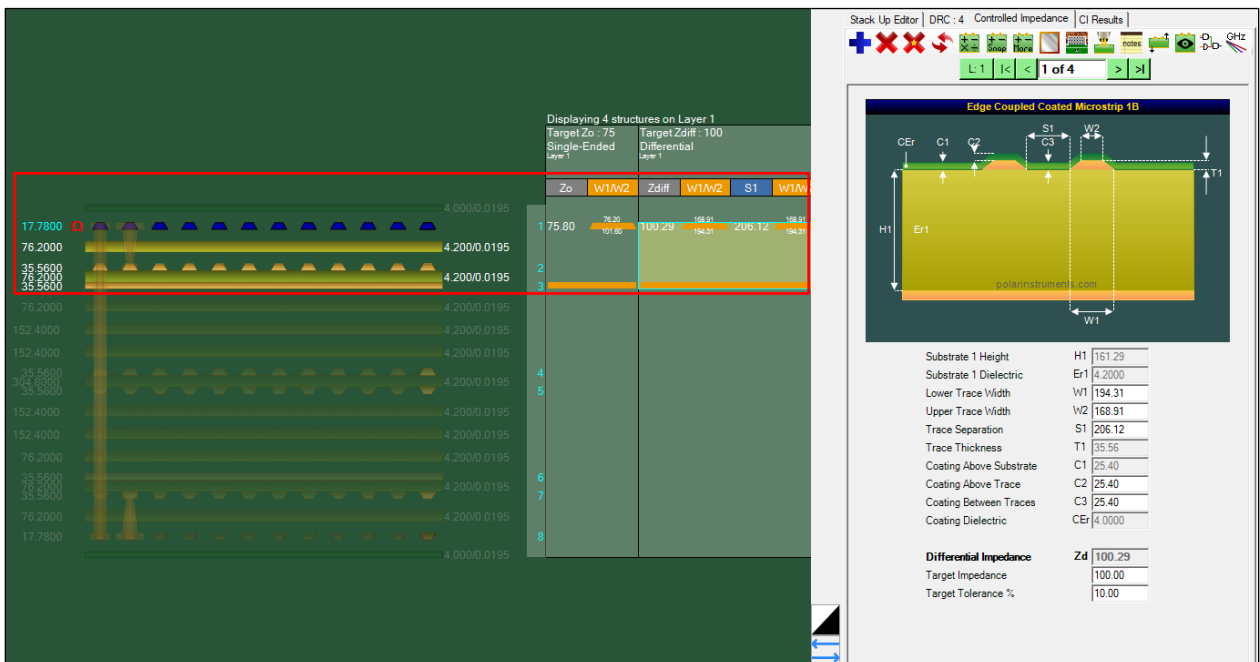

Click into an empty area in the Stackup Editor window to cancel the selection and display the whole stackup.

Exporting the structure view

From the File menu choose Export and choose Controlled Impedance Data (image)

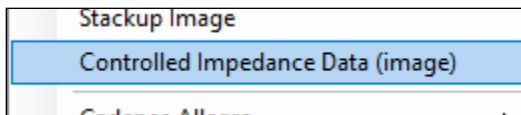

Choose the file format (JPEG, BMP, TIFF, or PNG)/

Specify the image quality if appropriate and the background and supply the path and filename

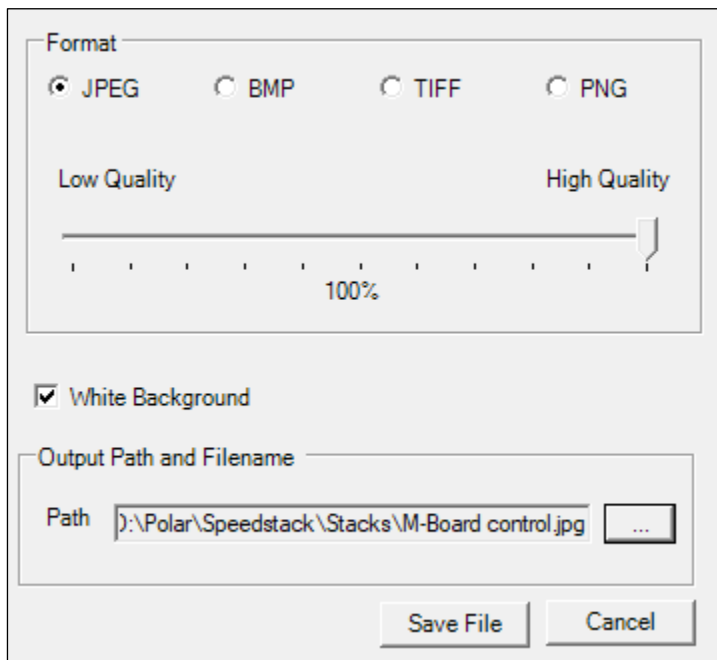

The Structure View is exported with the chosen options.

	Single-Ended Layer 1, 6		Differential Layer 1, 4			
	Zo	W1/W2	Zdiff	W1/W2	S1	W1/W2
1	75.74	76.20 101.60	100.29	168.91 194.31	206.12	168.91 194.31
2						
3						
4			101.28	158.75 184.15	215.90	158.75 184.15
5						
6						
7						
8	75.74	101.60 76.20				



Grid View

Grid View

The Grid View window provides a grid-based dialog view of the stack permitting multiple material properties to be edited from a single screen.

Using Grid View

Using Grid View allows rapid and direct user amending, for example, of the Finished Thickness / Isolation Distance of multiple materials without having to open the properties dialog of each material.

Stack Up Collection Index	Material Class	Material Element	Electrical Layer	Material Layer Type ID	Layer Name	Description	Processed Thickness	Dielectric Constant	Loss Tangent	Copper Coverage %
0	CSTSolderMask	Mask		SM		Liquid PhotoImageable Mask	25.40	4.0000	0.0000	
1	CSTFoil	Copper	1	Foil		Copper Foil	35.56			0.00
2	CSTPrePreg	Dielectric		PP		PrePreg 3113	100.71	4.2000	0.0000	
3	CSTPrePreg	Dielectric		PP		PrePreg 3113	100.71	4.2000	0.0000	
4	CSTCore	UpperCopper	2				35.56			0.00
4	CSTCore	Dielectric		Core		FR4 Core	203.20	4.2000	0.0000	
4	CSTCore	LowerCopper	3				35.56			0.00
5	CSTPrePreg	Dielectric		PP		PrePreg 3113	87.38	4.2000	0.0000	
6	CSTPrePreg	Dielectric		PP		PrePreg 3113	87.38	4.2000	0.0000	
7	CSTCore	UpperCopper	4				35.56			0.00
7	CSTCore	Dielectric		Core		FR4 Core	203.20	4.2000	0.0000	
7	CSTCore	LowerCopper	5				35.56			0.00
8	CSTPrePreg	Dielectric		PP		PrePreg 3113	87.38	4.2000	0.0000	
9	CSTPrePreg	Dielectric		PP		PrePreg 3113	87.38	4.2000	0.0000	
10	CSTCore	UpperCopper	6				35.56			0.00
10	CSTCore	Dielectric		Core		FR4 Core	203.20	4.2000	0.0000	
10	CSTCore	LowerCopper	7				35.56			0.00
11	CSTPrePreg	Dielectric		PP		PrePreg 3113	100.71	4.2000	0.0000	
12	CSTPrePreg	Dielectric		PP		PrePreg 3113	100.71	4.2000	0.0000	
13	CSTFoil	Copper	8	Foil		Copper Foil	35.56			0.00
14	CSTSolderMask	Mask		SM		Liquid PhotoImageable Mask	25.40	4.0000	0.0000	

Use the right-click menu to copy / paste the Grid View to the clipboard - the data may then be edited with Microsoft Excel
 Layer Name, Description, Processed Thickness, Dielectric Constant, Loss Tangent and Copper Coverage % columns are editable, other columns are read-only
 Processed Thickness = Copper.FinishedThickness, Dielectric.IsolationDistance, SolderMask.MaskThickness, Coverlay.FinishedThickness

Apply Cancel

Note: the text of the following fields can be edited:

- Layer Name
- Description
- Processed Thickness
- Dielectric Constant
- Loss Tangent
- Copper Coverage %.

Other fields are read-only.

To edit the text within a field, click on the field to select the text and amend or supply the new descriptive text for each material type as required – click Apply to apply the changes. The new values will be reflected in the Stackup Editor.

Recalculating the impedances

If a field value is edited that would cause the impedance of a structure to change, Speedstack will request a rebuild to recalculate the new impedance.



Rebuild and recalculate

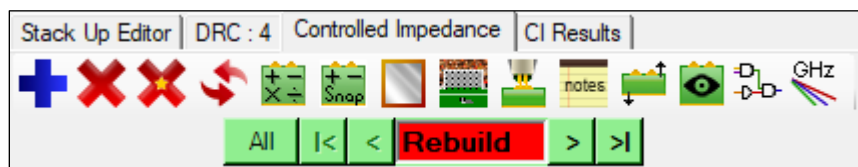

Using the Controlled Impedance window

The Controlled Impedance window displays all the controlled impedance structures and associated parameters for the selected layer.

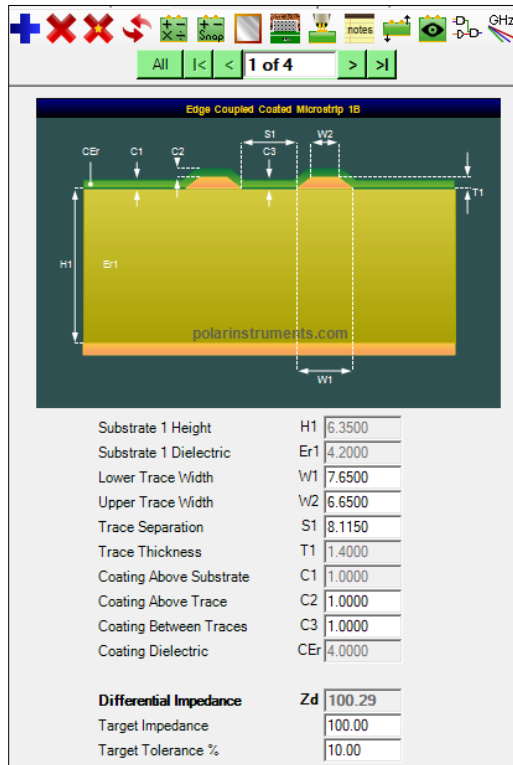

The screenshot shows the 'Controlled Impedance' window for a selected layer. At the top, there is a toolbar with various icons and a navigation bar showing '1 of 4' structures. Below the toolbar is a cross-section diagram of a microstrip structure on a substrate. The diagram is labeled 'Edge Coupled Coated Microstrip 1B' and shows parameters: H1 (Substrate Height), Er1 (Substrate Dielectric), W1 (Lower Trace Width), W2 (Upper Trace Width), S1 (Trace Separation), T1 (Trace Thickness), C1 (Coating Above Substrate), C2 (Coating Above Trace), C3 (Coating Between Traces), and CEr (Coating Dielectric). Below the diagram is a table of parameters:

Substrate 1 Height	H1	6.3500
Substrate 1 Dielectric	Er1	4.2000
Lower Trace Width	W1	7.6500
Upper Trace Width	W2	6.6500
Trace Separation	S1	8.1150
Trace Thickness	T1	1.4000
Coating Above Substrate	C1	1.0000
Coating Above Trace	C2	1.0000
Coating Between Traces	C3	1.0000
Coating Dielectric	CEr	4.0000
Differential Impedance	Zd	100.29
Target Impedance		100.00
Target Tolerance %		10.00

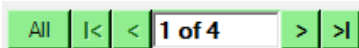

Step through the structures with the structure browse control – structures with the impedance within tolerance are shown in green, structures where the impedance is outside the specified tolerance range are shown in red.

The Speedstack menu system

The File menu

Stackups that incorporate controlled impedance structures are saved as *projects*.

The File menu allows for:

- Creation of new stackups and projects
- Opening and saving stackups and projects
- Searching for stackup and project files
- Generating printed output
- Importing and exporting existing stackups and projects and data files from companies providing data exchange with Speedstack.

Creating new stackups and projects

New stackups and projects may be created manually or with the assistance of the Stackup Wizard which steps the user

through the process of choosing the build type (foil, core or sequential HDI,) specifying the number of layers in the stack, the stack target thickness, plane and mixed/signal layers, drilling type (through plated/non-through plated.) and selection of materials.

Note: The actual Wizard options available will depend on whether Material Library mode or Virtual Material mode has been selected.

See Material Library and Virtual Material modes.

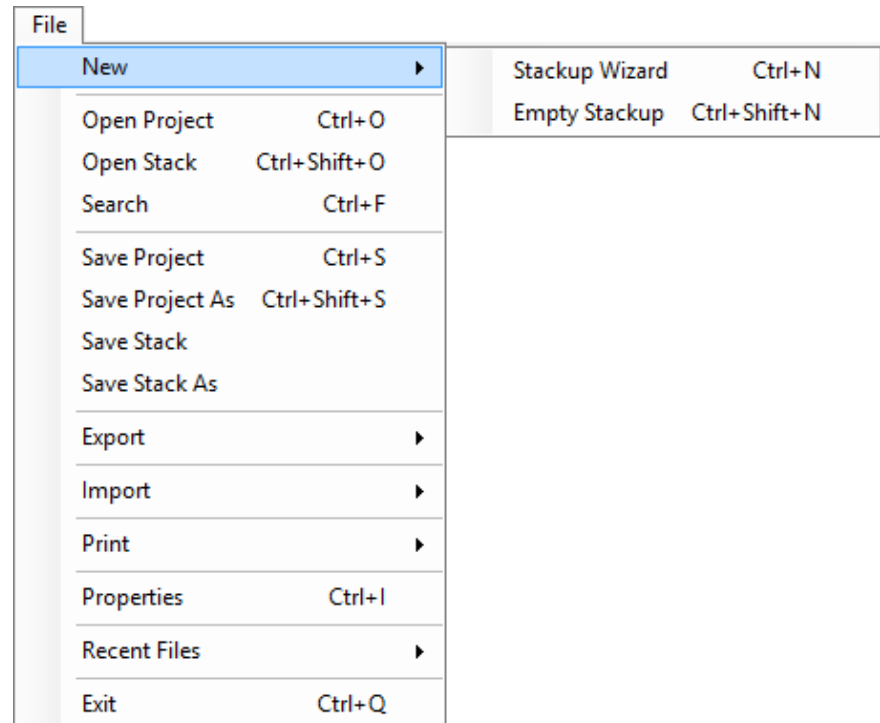

Using the Stackup Wizard in Material Library mode

Choosing the Stackup wizard in Material Library mode displays a dialog that allows the user to choose the build configuration and specify actual materials from the Speedstack material library

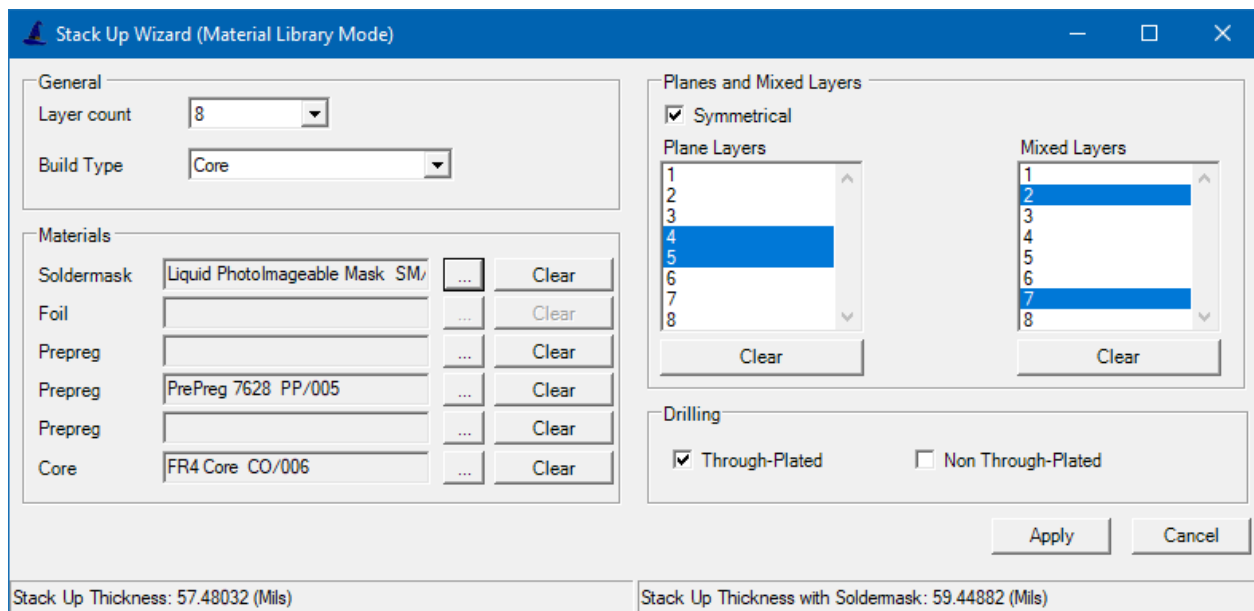

Stackup Wizard (Material Library mode)

Using the Stackup Wizard in Virtual Material Mode

Choosing the Stackup wizard in Virtual Material mode displays a dialog that allows the stack designer to build and experiment with a stackup without requiring real materials to be entered into a materials library.

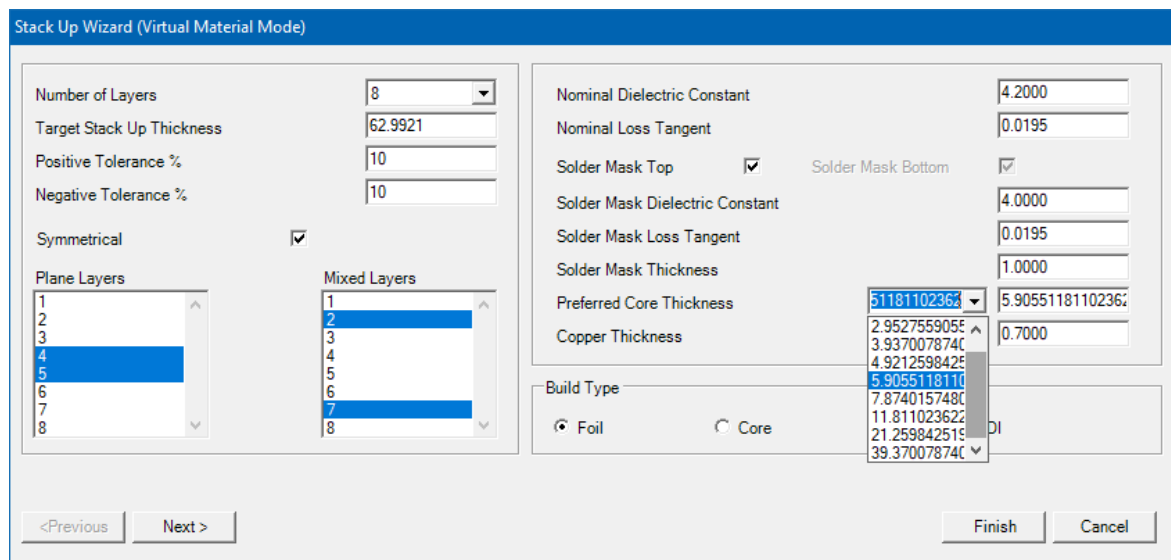

Stackup Wizard (Virtual Material Library)

In Virtual Material mode the designer specifies:

- stack details:
- the number of layers,
- overall board thickness,
- plane and mixed layers,
- core or foil build type,
- solder mask
- copper thickness

along with any transmission lines required on a layer.

Supply values for the material and solder mask thicknesses, dielectric constant and loss tangent to match the required design values. Speedstack will then build a stack to the specified board thickness by distributing the dielectric regions equally.



Apply Finishing



Reset Finishing

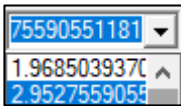

Preferred Core Thickness

Note: In Virtual Material mode the designer is working with finished dimensions so the Apply Finishing and Reset Finishing toolbar icons are disabled and shown greyed out.

Specifying preferred core thickness

If a preferred core thickness is specified, Speedstack will maintain the dielectric thickness for core regions but equally distribute prepregs to reach the target board thickness. Values can be selected from a drop-down list and modified and edited as required.

Opening projects

Stackups that incorporate controlled impedance structures are saved as projects. Click Open Project and navigate to the project folder; projects are saved as .sci files. The stackup along with all its design rule checking settings and controlled impedance information is loaded.

Saving stackups

Click the Save button to save the stackup. Users are recommended to save the stackup frequently during the stackup creation process to avoid data loss; stackups are saved as .stk files.

Saving projects

Use the Save Projects command to save a stackup along with its controlled impedance structures.

Searching for stackups and project files

When creating new stackups and projects it will often be found convenient and timesaving to reuse an existing stack or project, modifying as required and the saving as a new

stack or project. From the File menu choose Search and click Change Folder to navigate to the collection of stacks.

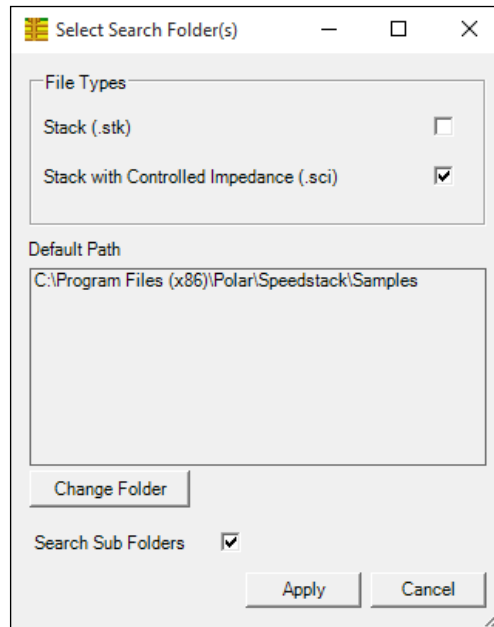

Choose from stacks and/or projects (stacks with controlled impedance); click Apply. The stackups and projects within the chosen folder structure are displayed.

Supplying search criteria

By default, all stack and project files in the folder are listed. The search may be refined by specifying layer count and board thickness.

For example, to display only 8-layer stacks click the Layer count check box and in the Number of Layers text box specify 8.

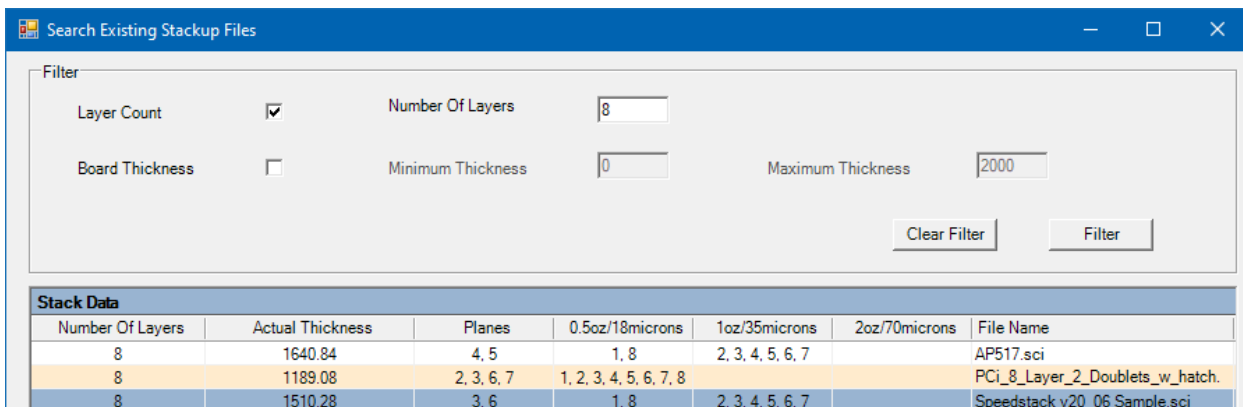

Similarly, check Board Thickness and specify minimum and maximum thickness to display only matching stacks.

Click Clear Filter to restore the display to all stack and project files.

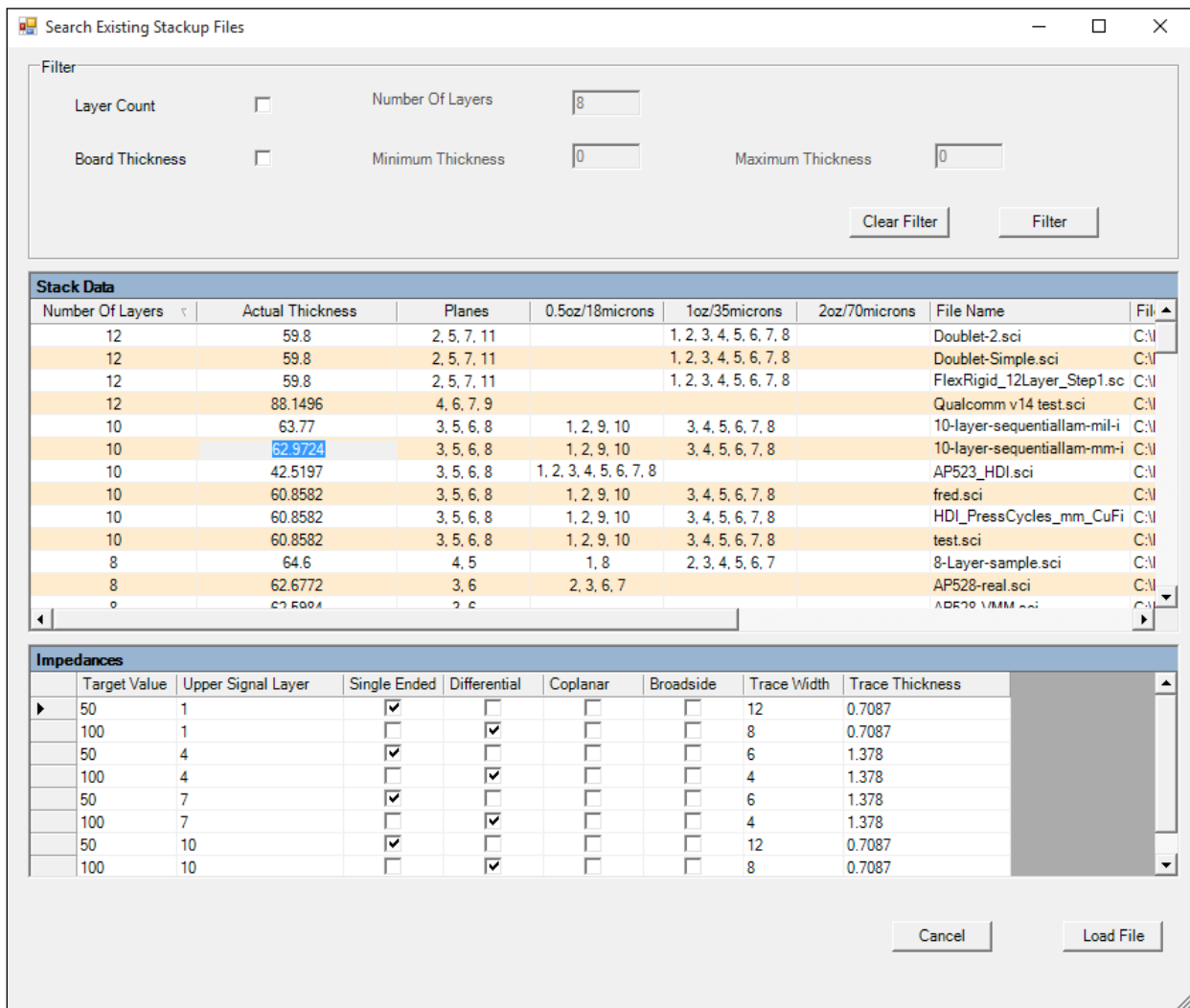

Step through the resulting list, choose the matching stack or project and click Load File.

Importing Stackup information

Speedstack incorporates the facility to read in files in:

- IPC-2581 Rev B format
- Ucamco Job File format
- XML STKX and SSX formats
- Zuken CR-8000 format
- Ucamco Integr8tor and Ucam format

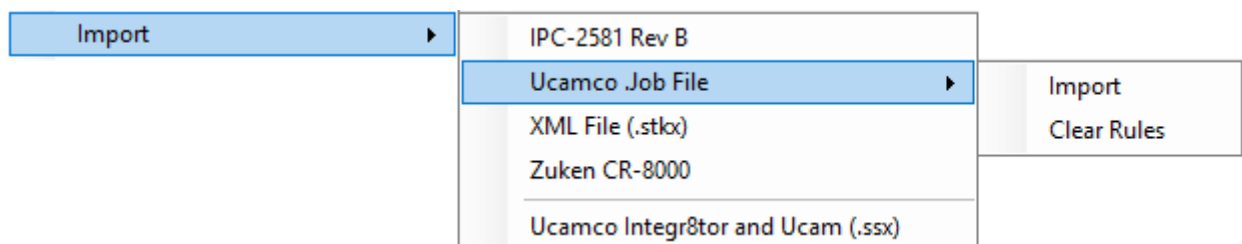

IPC-2581 Rev B

Speedstack can import Stackup and impedance structure data using the IPC-2581 Rev B XML file format.

Use the IPC-2581 Rev B command to import IPC-2581 Rev B (XML) files using the interactive interface.

The stack shown below displays both stackup material and structure information.

The foil, prepreg, core and solder mask material data grid colours are determined by the Speedstack Configuration,

Speedstack Layer Number	Layer Name	Specification Name	Layer Function	Side	Thickness	Sequence	Material Description	Resin Content	Dielectric Constant	Loss Tangent
	STACKUP THICKNESS				0.068600					
	LEGEND_TOP	LEGEND_TOP_SPEC	LEGEND	TOP	0.002000	1	Screened Ident			
	SOLDERMASK_TOP	SOLDERMASK_TOP_SPEC	SOLDERMASK	TOP	0.001000	2	Liquid Photoimageable Mask		4.000	
1	L1	L1_SPEC	SIGNAL	TOP	0.001400	3	Copper Foil			
	DIELECTRIC_1	DIELECTRIC_1_SPEC	DIELPREG	INTERNAL	0.003400	4	PrePreg 3113	53.00	4.200	0.0350
	DIELECTRIC_2	DIELECTRIC_2_SPEC	DIELPREG	INTERNAL	0.003400	5	PrePreg 3113	53.00	4.200	0.0350
2	L2	L2_SPEC	MIXED	INTERNAL	0.002100	6	FR4 Core			
	DIELECTRIC_3	DIELECTRIC_3_SPEC	DIELCORE	INTERNAL	0.008000	7	FR4 Core	45.00	4.200	0.0350
3	L3	L3_SPEC	SIGNAL	INTERNAL	0.001400	8	FR4 Core			
	DIELECTRIC_4	DIELECTRIC_4_SPEC	DIELPREG	INTERNAL	0.003600	9	PrePreg 3113	53.00	4.200	0.0350
	DIELECTRIC_5	DIELECTRIC_5_SPEC	DIELPREG	INTERNAL	0.003600	10	PrePreg 3113	53.00	4.200	0.0350
4	L4	L4_SPEC	PLANE	INTERNAL	0.001400	11	FR4 Core			
	DIELECTRIC_6	DIELECTRIC_6_SPEC	DIELCORE	INTERNAL	0.008000	12	FR4 Core	45.00	4.200	0.0350
5	L5	L5_SPEC	PLANE	INTERNAL	0.001400	13	FR4 Core			
	DIELECTRIC_7	DIELECTRIC_7_SPEC	DIELPREG	INTERNAL	0.003600	14	PrePreg 3113	53.00	4.200	0.0350
	DIELECTRIC_8	DIELECTRIC_8_SPEC	DIELPREG	INTERNAL	0.003600	15	PrePreg 3113	53.00	4.200	0.0350
6	L6	L6_SPEC	SIGNAL	INTERNAL	0.001400	16	FR4 Core			
	DIELECTRIC_9	DIELECTRIC_9_SPEC	DIELCORE	INTERNAL	0.008000	17	FR4 Core	45.00	4.200	0.0350
7	L7	L7_SPEC	MIXED	INTERNAL	0.002100	18	FR4 Core			
	DIELECTRIC_10	DIELECTRIC_10_SPEC	DIELPREG	INTERNAL	0.003400	19	PrePreg 3113	53.00	4.200	0.0350
	DIELECTRIC_11	DIELECTRIC_11_SPEC	DIELPREG	INTERNAL	0.003400	20	PrePreg 3113	53.00	4.200	0.0350
8	L8	L8_SPEC	SIGNAL	BOTTOM	0.001400	21	Copper Foil			
	SOLDERMASK_BOTTOM	SOLDERMASK_BOTTOM_SPEC	SOLDERMASK	BOTTOM	0.001000	22	Liquid Photoimageable Mask		4.000	

The Import IPC-2581 Rev B dialog above provides user guidance through the import process.

The IPC-2581 File Information pane displays useful file data including

- File name,
- Revision
- Units

IPC-2581 supports inches, millimetres and microns.

The Software Package pane details the application (including the revision and vendor) that generated the IPC-2581 file.

Setting import options

Set the import options to control how the IPC-2581 data is allocated in Speedstack:

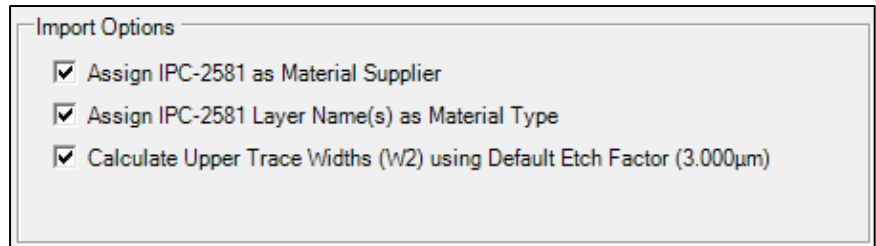

The material type can optionally be derived from the layer name and the upper trace width can be derived from the given trace width and default etch factor.

Setting display options

From the Display Options dialog pane choose to display all data or stackup or structure data only

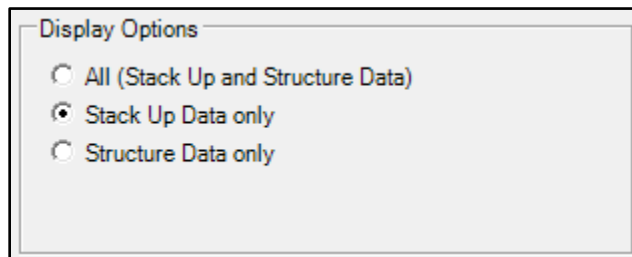

Sorting layer information

The stackup imported from the IPC-2581 file is shown in data grid form. Data can be sorted by column – click on each column header to sort in ascending or descending order by sequence, layer number, layer name, etc.

Assigning layer functions

During the import process it may be necessary to consult the board authority or design documentation to ascertain the function of each layer, signal, plane, dielectric, core, etc.; the Layer Function determines the layer / material type.

Right click each layer and use the Set Layer Function to assign the layer its designated function.

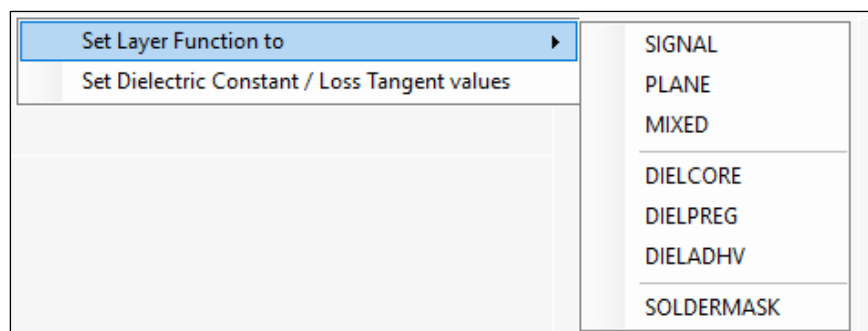

Setting loss values

Dielectric constant and loss tangent values can be set for each layer; select the layer (it will highlight in blue) and then right click the layer; the dialog should show the current values; enter each value and click Apply.

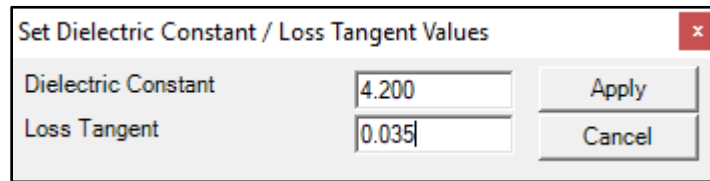

With all the editing completed, click Import to bring the file into the Speedstack Editor.

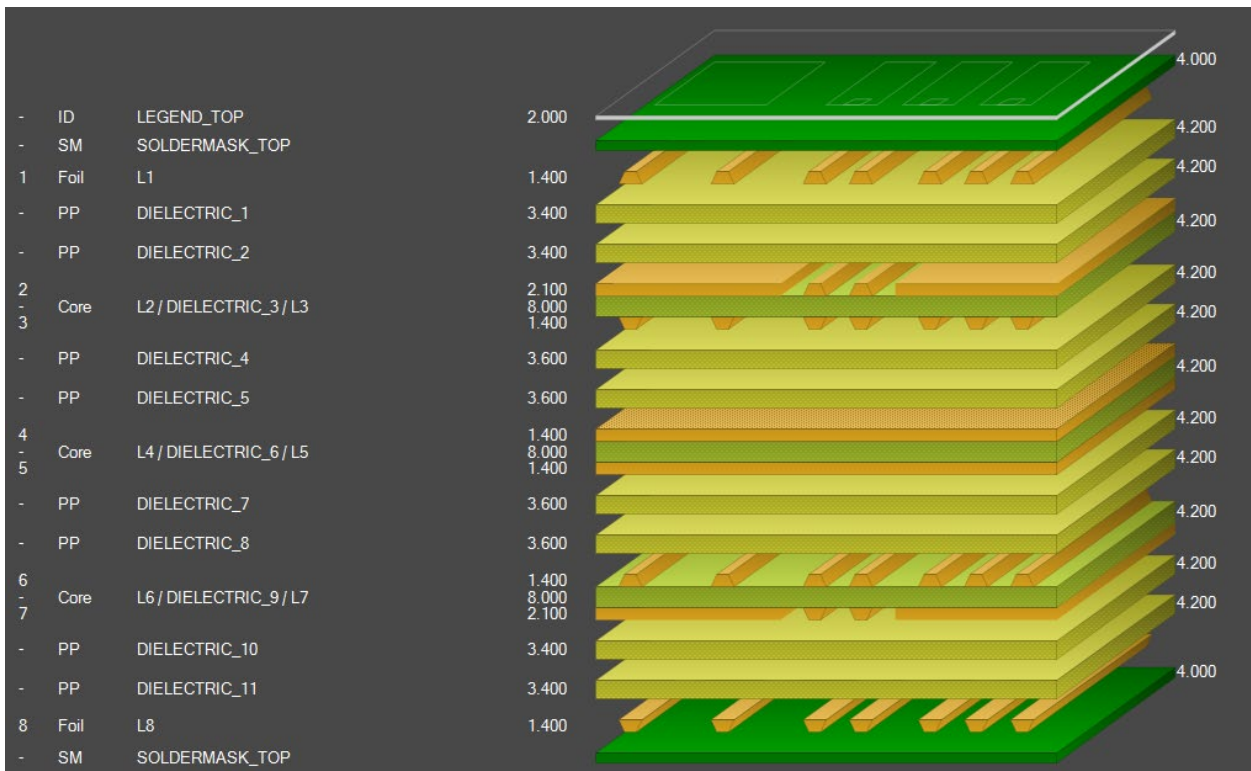

The imported stack can be processed using the Speedstack editing functions.

Ucamco Job Files

The .Job file format contains a varying amount of stackup information depending upon the how the system has been configured by the Ucam user.

Speedstack will import files from both Ucam and Integr8tor.

Choose File|Import|Ucamco Job File|Import and select the .job file and click Open. The Ucamco .Job File Import dialog is displayed:

Ucamco Job File Import

Please map each .Job layer / drill class assignment to the equivalent Speedstack material type:

1. Select a class from the right-most list
2. Click the button to nominate the material / layer type

.Job Extra Assignments

Solder Mask	▼	netref
Idents	▼	<div style="border: 1px solid gray; padding: 2px;"> netref help outline PAS TZD MGL PZD </div>
Peelables	▼	

.Job Layer Assignments

Signal	▼	fluid
Mixed	▼	<div style="border: 1px solid gray; padding: 2px;"> fluid solid mixed </div>
Power	▼	
Hatched	▼	

.Job layer classes that are unassigned will be imported as Signal

.Job Drill Assignments

Laser	▼	drill
Plated	▼	<div style="border: 1px solid gray; padding: 2px;"> drill production </div>
Nonplated	▼	

Reset
Apply
Cancel

The .Job file contains user-definable material / drill class definitions so it will be necessary to map these definitions to the various Speedstack material and drill types.

To apply assignments, select the class from the drop down list then click the associated button to nominate the material or layer type. Click Apply.

Note: Where stack data are not included in the .job file it will be necessary to include or update properties (for example, solder mask properties such as thickness and dielectric constant) before adding impedance structures.

Integr8torJob files

When Integr8tor files are imported the Ucamco .Job File Import dialog is displayed as shown below.

Ucamco .Job File Import

Please map each .Job layer / drill class assignment to the equivalent Speedstack material type:

1. Select a class from the right-most list
2. Click the button to nominate the material / layer type

.Job Extra Assignments

Solder Mask	[]	paste
Idents	[]	paste silk soldemask
Peelables	[]	

.Job Layer Assignments

Signal	[]	outer
Mixed	[]	outer inner
Power	[]	
Hatched	[]	

.Job layer classes that are unassigned will be imported as Signal

.Job Drill Assignments

Laser	[]	plated
Plated	[]	plated rout
Nonplated	[]	

Reset Apply Cancel

Select the assignment options as described above and click Apply. Click Reset to clear the assignments.

Clear Rules

The Clear Rules command will delete all previously learned rules.

XML files

Choose File|Import|XML File (.stkx), select the .stkx file for import and click Open.

Zuken CR-8000

Choose File|Import|Zuken CR-8000 format, select the .stkx file for import and click Open.

Ucamco Integr8tor and Ucam format (.ssx)

Choose File|Import|Ucamco Integr8tor and Ucam format, select the .ssx file for import and click Open.

Converting imported electrical layers to cores

When importing stackup data from some CAD / CAM systems only the electrical layers are defined. In this case copper layers may appear adjacent each other in the Stackup Editor. Speedstack allows the user to quickly convert two adjacent electrical layers into Core or Flexible Core materials using the Convert to Core function.

Select the adjacent layers within the stack – Speedstack adds the Convert to Core command to the Edit menu.

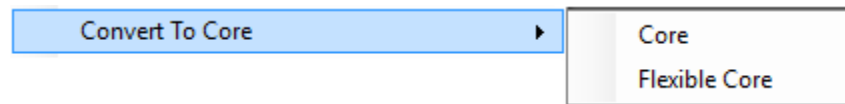

Select the Core type – Speedstack displays the core library; select the core – the layers are converted into the selected core; note that when converting two foils to a single core material the lower copper trace will be shown inverted.

Consider the stack below. Using ‘Convert to Core’ alongside other Speedstack editing functions, an electrical layer only stackup can be converted into a useful fully defined stackup containing full definitions of foils, prepreg and core materials.



Add a prepreg layer between layers 1 and 2.

Repeat for layers 3 and 4, 5 and 6 and 7 and 8.

Select layers 2 and 3 and convert to a core.

Repeat for layers 4 and 5, 6 and 7.

The resulting stack should appear similar to the stack below.

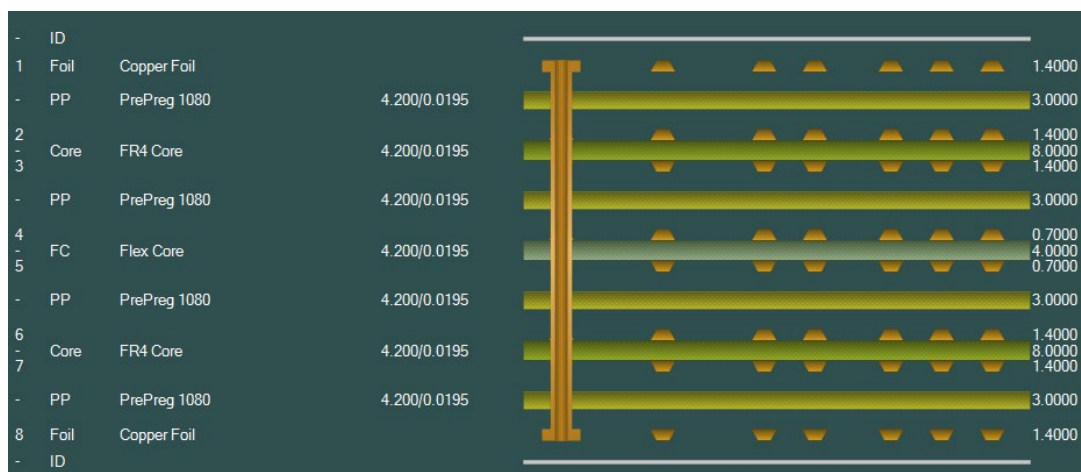

Exporting stackup information

Speedstack incorporates the facility to export stack data to external programs. From the File menu choose Export and choose the format from the Export sub-menu.

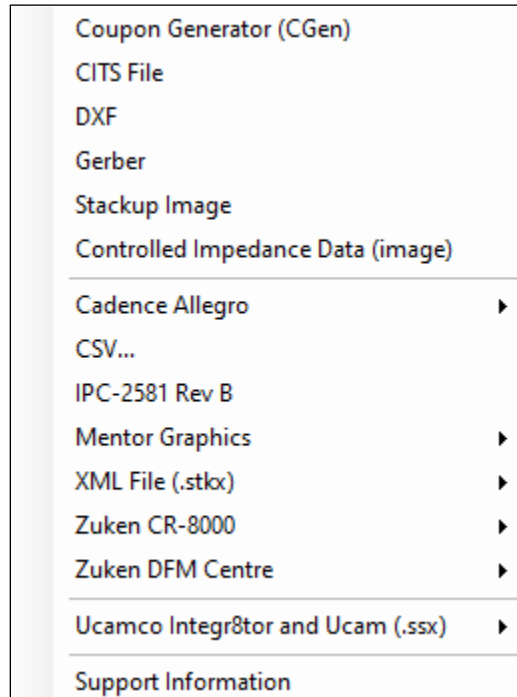

Exporting to Coupon Generator (CGen)

Stacks may be exported to Polar CGen Coupon Generator (the stack will be exported via the *Speedstack Clipboard*) for processing into test coupons. Click Export To | Coupon Generator (CGen) – open CGen and from the File menu, import the Speedstack Clipboard (see *CGen User Guide*.)

Export CITS File

Use the Export CITS File to create test files for Polar CITS controlled impedance test systems. Supply board details via the Board Details dialog.

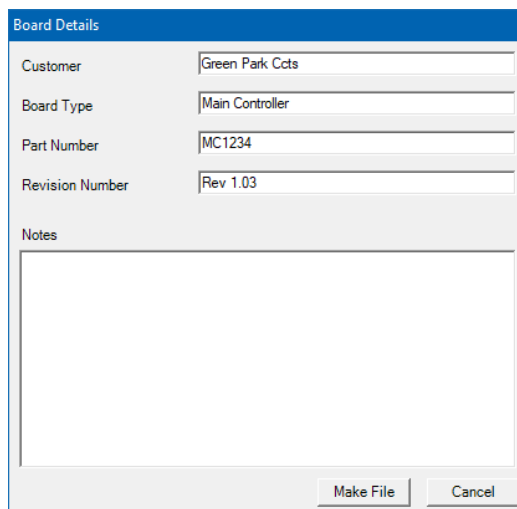

Click Make File to generate .cif files (CITS test files).

Generating printed output

Speedstack can generate printed output in DXF, Gerber, CSV and XML, as well as graphic image formats.

DXF, Gerber, CSV and XML files

Choose DXF..., Gerber..., CSV... or XML File and navigate to a suitable folder, name the file as appropriate and save. For the XML option, specify the XML/.stkx file format from the file format dropdown.

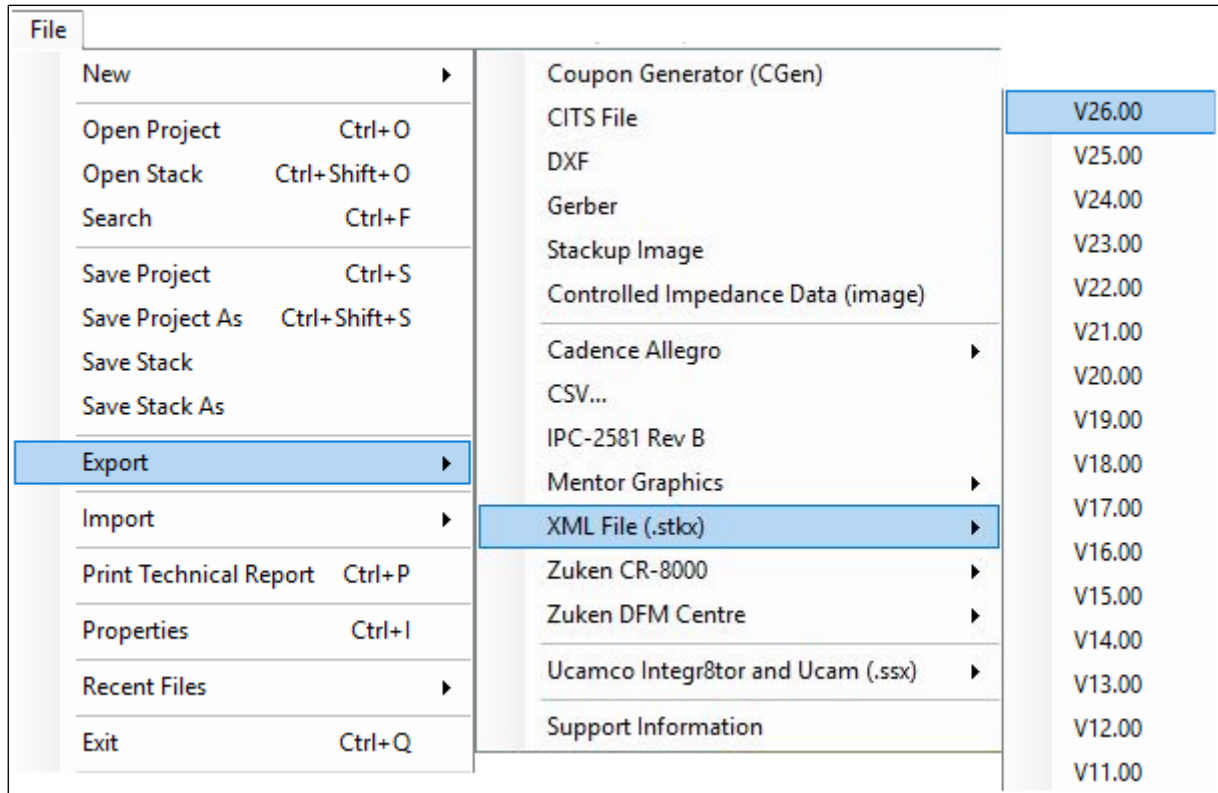

Stackup images

Speedstack can export stackup images in JPEG, BMP, TIFF and PNG file formats. Select from 2D or 3D displays.

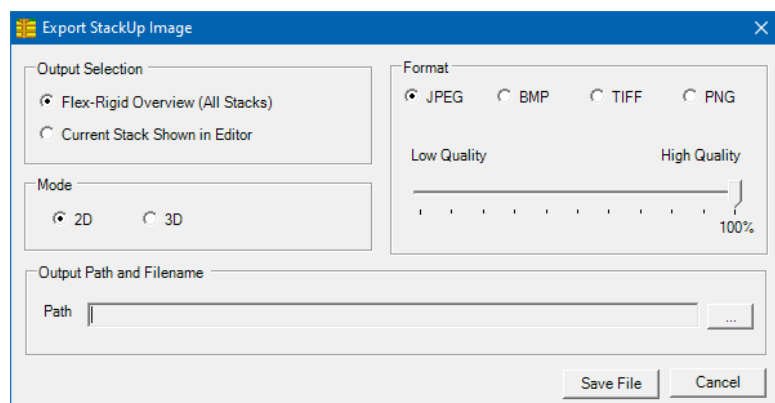

Use the Low Quality – High Quality slider to specify JPG quality. Choose the Flex-Rigid Overview (All Stacks) to display the master stack and associated sub-stacks or just the Current Stack Shown in Editor. Specify the destination folder and file name and save.

Controlled Impedance Data (image)

See Structure View – Exporting the structure view

Cadence Allegro (IPC-2581 Rev B)

Speedstack supports reading/writing in IPC-2581 Rev B .xml formatted data. Choose the Cadence Allegro/IPC-2581 Rev B option and supply the file name and destination folder: the Export IPC-2581 Rev B dialog is displayed.

Speedstack Layer Number	Layer Name	Specification Name	Layer Function	Side	Thickness	TolPlus	TolMinus	Sequence	Material Description	Resin Content
	SOLDERMASK_TOP	SOLDERMASK_TOP_SPEC	SOLDERMASK	TOP	0.001000	0.000000	0.000000	1		
1	L1	L1_SPEC	MIXED	TOP	0.001400	0.000000	0.000000	2		
	DIELECTRIC_1	DIELECTRIC_1_SPEC	DIELPREG	INTERNAL	0.005977	0.000000	0.000000	3		47.00
	DIELECTRIC_2	DIELECTRIC_2_SPEC	DIELPREG	INTERNAL	0.005977	0.000000	0.000000	4		47.00
	DIELECTRIC_3	DIELECTRIC_3_SPEC	DIELPREG	INTERNAL	0.005977	0.000000	0.000000	5		47.00
2	L2	L2_SPEC	MIXED	INTERNAL	0.001400	0.000000	0.000000	6		
	DIELECTRIC_4	DIELECTRIC_4_SPEC	DIELCORE	INTERNAL	0.021000	0.000000	0.000000	7		41.00
3	L3	L3_SPEC	MIXED	INTERNAL	0.001400	0.000000	0.000000	8		
	DIELECTRIC_5	DIELECTRIC_5_SPEC	DIELPREG	INTERNAL	0.005977	0.000000	0.000000	9		47.00
	DIELECTRIC_6	DIELECTRIC_6_SPEC	DIELPREG	INTERNAL	0.005977	0.000000	0.000000	10		47.00
	DIELECTRIC_7	DIELECTRIC_7_SPEC	DIELPREG	INTERNAL	0.005977	0.000000	0.000000	11		47.00
4	L4	L4_SPEC	MIXED	BOTTOM	0.001400	0.000000	0.000000	12		
	SOLDERMASK_BOTTOM	SOLDERMASK_BOTTOM_SPEC	SOLDERMASK	BOTTOM	0.001000	0.000000	0.000000	13		
	STACKUP THICKNESS				0.064460					

Choosing export options

Use the dialog to modify, if necessary, the file information details and choose the export options.

Specify whether Speedstack’s *target* or *calculated* impedance is to be used to populate the IPC-2581 file.

Supply a value for the resin rich dielectric constant and click Apply. Click Export.

Mentor Graphics

Choose the Mentor Graphics option, choose the file version and supply the file name and destination folder. (Note the .ssx file extension.)

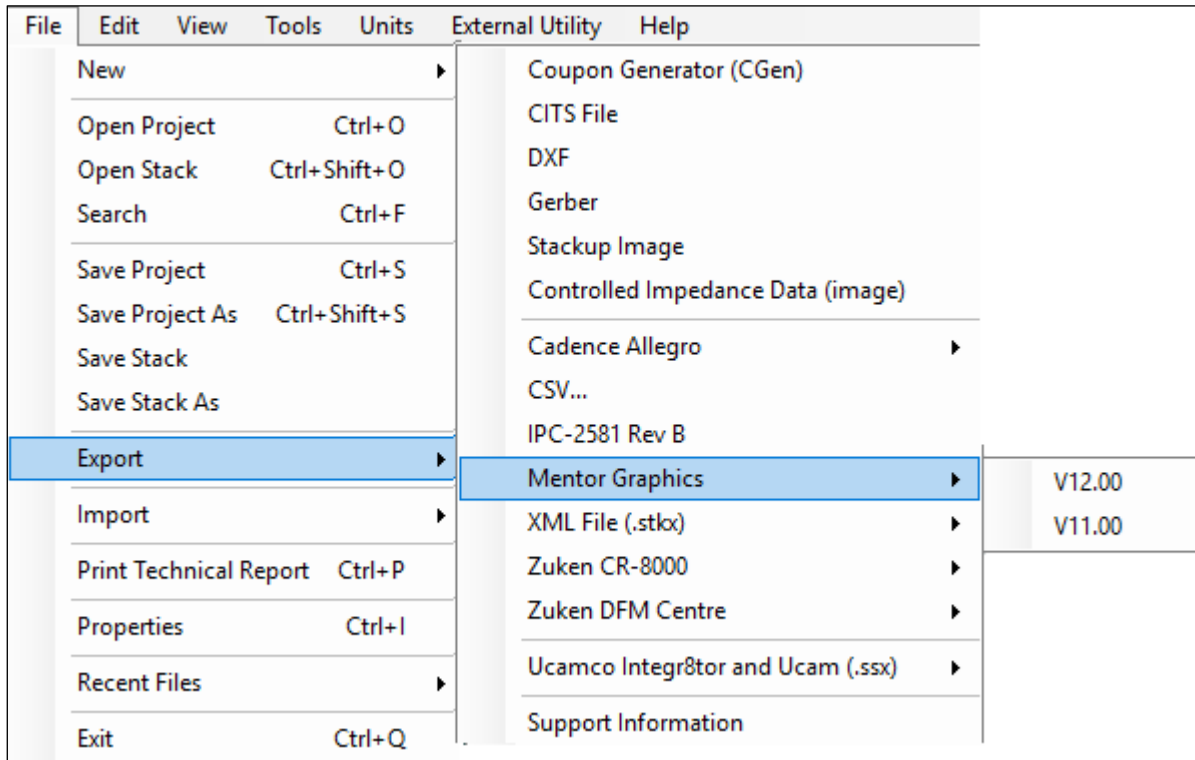

Zuken CR-8000/DFM Centre

The Zuken CR-8000 and DFM Center PCB manufacturing pre-processing and CAM systems integrate directly with Polar Instruments' Speedstack PCB system. Choose the file version, navigate to a suitable folder and save the file (XML format).

Ucamco Integr8tor and Ucam

Choose Ucamco Integr8tor and Ucam option and file version.

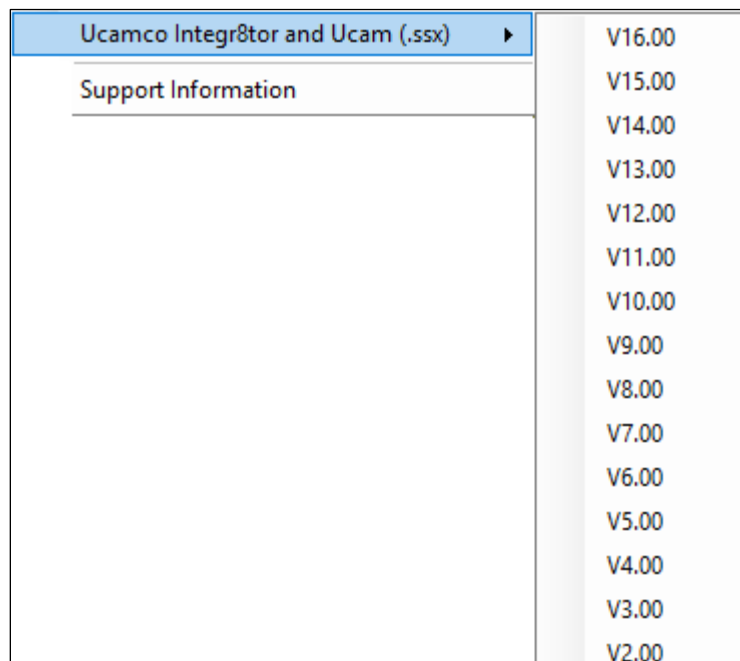

and supply the file name and destination folder. (Note the .ssx file extension.)

Assigning properties to projects and stackups

The stack file Properties dialog may be displayed automatically each time a new stackup is created (see Tools|Options|General) and provides a range of text fields for descriptive information, stackup name, stackup author, company name, file create date, version, etc.

From the File menu choose the Properties command to add descriptive text fields — information contained in the Properties dialog will be displayed on stackup printouts.

To display the Properties dialog each time a new stackup or project is created, from the Tools menu choose Options and click the check box below on the General tab

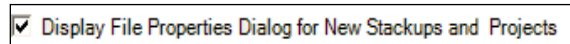

Backing up stackups and libraries

It is strongly recommended that stackup files (assigned the .stk extension), project files (assigned the .sci extension) and library files (assigned the .mlbx extension) be backed up to a secure location.

Opening recent files

Click Recent Files to select and open a file from the most recently used file list.

The Edit menu

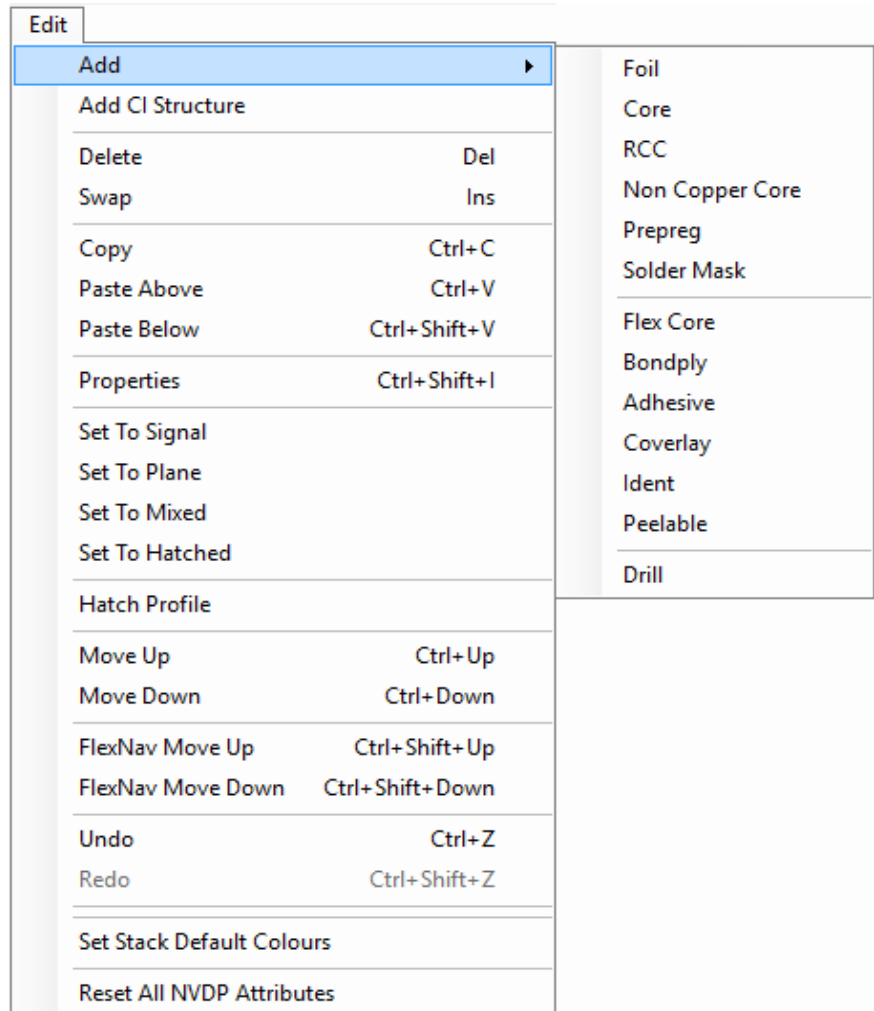

The Edit menu contains the commands necessary to create and modify board stackups. The designer or fabricator works within the free-form stackup build and construction window and in Materials Library mode adds layers of foil, core, prepreg, etc., from the materials library.

Material Library and Virtual Material modes

Speedstack provides the option to switch easily between Material Library and Virtual Material modes

This will allow the stack designer to build and experiment with stackups (for example, to examine the effects on impedance structures of different trace widths or dielectric heights) without requiring real materials to be entered into a materials library.

Controlled impedance structures can be added to the stack. When Add CI Structure is selected Speedstack switches to the Controlled Impedance pane and allows the designer to add structures appropriate for the selected layer.

The items that can be edited depend upon whether the StackupEditor or Controlled Impedance tab is selected.

Layers can be changed to signal, plane, mixed or hatched, moved up or down or copied and pasted, or assigned properties as required.

Use the Delete and Swap commands to delete materials or swap materials from the Materials Library.

The View menu

Use the View menu to change the Stack Editor display whilst adding or removing materials or modifying or refining the stack.

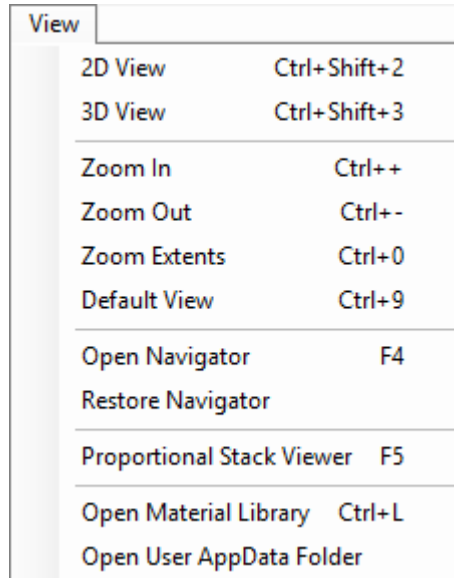

The image shows a screenshot of the 'View' menu in the Speedstack software. The menu is open, displaying a list of options with their corresponding keyboard shortcuts. The options are: 2D View (Ctrl+Shift+2), 3D View (Ctrl+Shift+3), Zoom In (Ctrl++), Zoom Out (Ctrl+-), Zoom Extents (Ctrl+0), Default View (Ctrl+9), Open Navigator (F4), Restore Navigator, Proportional Stack Viewer (F5), Open Material Library (Ctrl+L), and Open User AppData Folder.

View	
2D View	Ctrl+Shift+2
3D View	Ctrl+Shift+3
Zoom In	Ctrl++
Zoom Out	Ctrl+-
Zoom Extents	Ctrl+0
Default View	Ctrl+9
Open Navigator	F4
Restore Navigator	
Proportional Stack Viewer	F5
Open Material Library	Ctrl+L
Open User AppData Folder	

The View menu allows Speedstack to display the stackup in a 2-dimensional or 3-dimensional aspect.

Zoom In to get a close-up view of the stack or Zoom Out to see more of the stack at a reduced size. Zoom Extents will adjust the zoom level to display the whole stack.

Hint: Click the mouse centre button/wheel to Zoom Extents.

With the Flex / HDI option installed choose the Open Navigator command to view the master and associated sub-stacks. The floating Navigator window may get covered by other application windows when switching between programs; – use the Find Navigator to display a reduced Navigator window at the top left screen corner.

Proportional Stack Viewer

Use the Proportional Stack Viewer to display the stack currently selected in the Stack Editor so the material thicknesses are shown proportional to each other. This can be informative as a visual aid, especially when considering the dielectric thicknesses between electrical layers.

The Tools menu

Use the Tools menu to:

- configure Speedstack
- set manufacturing constraints
- set the finishing method
- set the target stackup thickness
- enable prepreg and copper finishing
- check the copper coverage percentage set for each layer
- switch between library and virtual material modes
- choose the display language

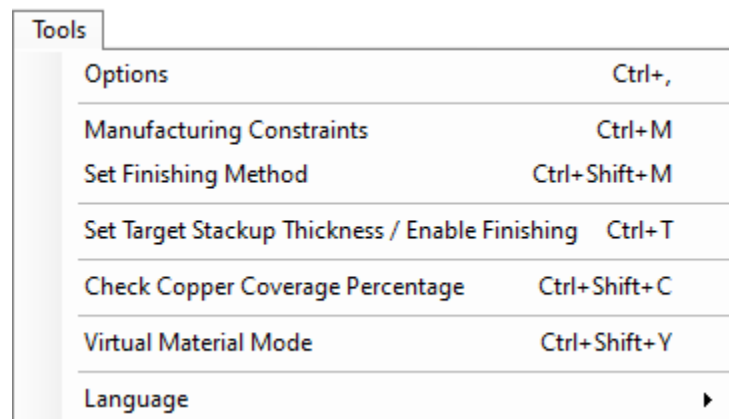

The Options command displays the configuration options, manufacturing constraints, target stack thickness and finishing options. See *Configuring Speedstack* for details.

The Units menu

Use the Units menu to select the stackup units, Microns, Mils/Thous, Millimetres or Inches

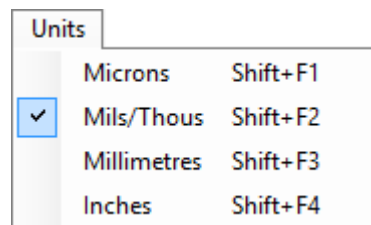

External Utility

Use the External Utility commands to start a program external to Speedstack. The programs are defined in the Configuration Options|External Utilities dialog.

The Help menu

Use the Help menu commands to access the User Guide for the current Speedstack version or tutorials relating to common Speedstack operations.

Review the licensing terms with the License and About Speedstack commands.

Configuring Speedstack

When first run, the Speedstack environment is initialised to its factory settings. These may require adjustment before outputting a finished stackup and/or project. Default settings are changed using Tools|Options, Tools|Manufacturing Constraints and Tool|Set Finishing Options.

Environment and default settings

From the Tools menu choose the Options command to display the Configurations Options dialog.

General Options

Choose the Default Stackup View – 2D or 3D; select the data fields that will appear alongside the stack in the Stack Editor

Choose the stackup units; Speedstack supports Mils/Thou, Microns, Millimetres and Inches. Click the Open last used... check box to specify that Speedstack should open the last used file on start-up.

Note: Processed Thickness is the Finished Thickness for copper layers and Isolation Distance for dielectric layers.

Clicking the Display File Properties Dialog... will display the File Properties Dialog each time a new stackup or project is initiated.

Structure Defaults

Structures	Default	Snap To
Lower Trace Width (W1)	250.00	5.00
Upper Trace Width (W2)	247.00	5.00
Lower Ground Strip Width (G1)	2500.00	5.00
Upper Ground Strip Width (G2)	2475.00	5.00
Trace Separation (S1)	250.00	5.00
Ground Strip Separation (D1)	250.00	5.00
Trace Offset (O1)	0.00	5.00
Separation Region Dielectric (REr)	4.0000	

Board Thickness	
Board Thickness	1600.00
Plus %	10
Minus %	10

Drilling	
Minimum Hole Size	500.00

When adding new controlled impedance structures default values (shown above in microns) are entered for the structure parameters. Use the Structure Defaults tab to specify the default structure parameters, for example trace widths and separations board thickness and minimum drill hole size.

The Snap To value may be set for each parameter. Note that although all Snap To values shown above are set to 5.00 microns, each parameter value can be set individually.

Licensing

Use the Licensing tab to tick the purchased licensing options.

<input type="radio"/> Speedstack License Only
<input type="radio"/> Enable Speedstack PCB and Si8000m link
<input checked="" type="radio"/> Enable Speedstack Si and Si9000e link
License Options:
<input checked="" type="checkbox"/> Speedstack Flex / HDI License (SF)
<input checked="" type="checkbox"/> Hatch Mode License (XFE)
<input checked="" type="checkbox"/> Speedstack Import / Export License (IO)
<input checked="" type="checkbox"/> Speedstack / Ucamco Integration License (UCAMCO)

To activate the Speedstack controlled impedance function, ensure that the Si8000 or Si9000 is installed; from the Licensing tab choose either Use Polar Si8000m License or Use Polar Si9000e License option as appropriate.

Choosing default file locations

Select default materials library file	C:\Program Files (x86)\Polar\Speedstack\Samples\Speedstack Metric.mlbx	Browse...
Select default folder to store Stack Up (*.stk) files	C:\Program Files (x86)\Polar\Speedstack\Samples	Browse...
Select default folder to store Material Filter (*.mlf) files	C:\Program Files (x86)\Polar\Speedstack\Samples\Filters	Browse...
Select default folder to store custom print settings (*.prs) files	C:\Program Files (x86)\Polar\Speedstack\Samples\Filters	Browse...

Use this dialog to choose which materials library the Speedstack uses at start-up. Click the File Locations tab and use the Browse button to navigate to the library (.mlbx) file.

The File Locations tab provides for default locations for stackup or project files, Material Filter (.mlf) files and custom print settings (.prs) files. Browse to the target folders and click OK to confirm (create new folders if necessary).

Specifying goal seeking parameters

Click the Goal Seeking tab to specify the default values for trace widths and separations used during goal seeking.

W1 Maximum Trace Width	300.00	Convergence	0.50
W1 Minimum Trace Width	125.00	Maximum Iterations	10
S1 Maximum Trace Separation	300.00		
S1 Minimum Trace Separation	125.00		
D1 Maximum Trace Separation	300.00		
D1 Minimum Trace Separation	125.00		
H Maximum Value	200.00		
H Minimum Value	50.00		

During goal seeking the calculated value for impedance will progressively converge upon the target value.

In the Convergence text box specify the difference between the target impedance and the actual impedance at which goal seeking will terminate.

Use the Maximum Iterations text box to limit the number of iterations used during goal seeking.

Setting user defaults

Information added to the User tab will be transferred to the File Properties dialog and used on printouts

Enter information as appropriate into the associated text fields; optionally, select a graphic for use as the company logo — optimum graphic size is 180 x 32 pixels — the graphic is printed in the preview box.

Default User Information Used to fill in stack property fields when starting a new stack file.		Company Logo	
Author	<input type="text" value="J Travers"/>	<input type="text" value="D:\Polar\Graphics\Polar Logos\NewPolar"/>	<input type="button" value="Browse..."/>
Company	<input type="text" value="XYZ Corp"/>	Recommended size for the logo is 180 pixels in width. Large images will be scaled down.	
Department	<input type="text" value="Engineering"/>		
Site	<input type="text" value="North Bridge"/>		

Specifying default CITS test file parameters

Speedstack allows the user to generate a CITS test file for each controlled impedance structure within the stack.

Select the CITS Test tab to specify the default test parameters to be used when initiating a CITS test file.

Horizontal Units		Channels	
Units	<input type="text" value="Inches"/>	Single Ended	<input type="text" value="Channel 1"/>
Test From	<input type="text" value="3"/>	Differential	<input type="text" value="Channel 1 & 2"/>
Test To	<input type="text" value="7"/>		
Test Method	<input type="text" value="Absolute"/>		
Vertical Scale	<input type="text" value="10"/>		
Differential Unbalanced Warning Level	<input type="text" value="15"/>		

Each test file contains the test parameters (test units, distance, number of channels, etc.) to be used when testing the stack's controlled impedance structures using a Polar CITS (Controlled Impedance Test System). The test file may be edited via the Edit Test Data dialog.

CITS test methods

Note that the preferred test method is **Absolute**

*The **Average** method should only be used with the express approval of the specifying authority.*

See Polar Application Note AP8515 – *CITS Test Methods*

Choosing background and stackup layer colours

Choose the Colours tab to change stackup component colours from their factory defaults.

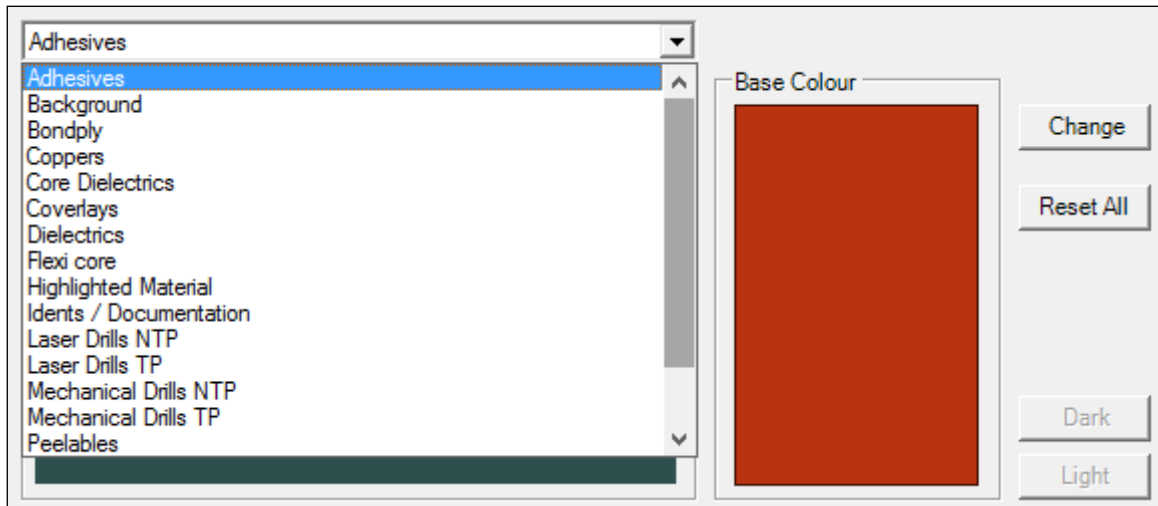

Click Reset All to return to cancel changes.

Miscellaneous Options

Number of Undo Levels	<input type="text" value="5"/>
Maximum Laser Drilled Layers	<input type="text" value="5"/>
<input checked="" type="checkbox"/> Drill Validation Check	

This option prevents invalid drills from being added to the stack up. For instance, a drill that starts from the lower copper side of core materials. Uncheck this option if you use a drilling technology that permits drills to be placed between electrical layers which are not typically supported by conventional mechanical and laser drills

Use the Miscellaneous tab to:

- Specify the maximum number of undo for editing actions
- Choose the maximum number of layers a laser drill can span. (Exceeding this number will produce a Drill not Valid error message.)
- Apply Drill Validation Check – preventing invalid drills being added to the stackup. Unchecking this option will disable the Speedstack invalid drills check in order to support the Ormet® Z-Axis Interconnect* technology

* Ormet® Z-Axis Interconnect is a method of connecting two PCB boards using a conductive paste filled into the vias of a drilled prepreg.

Hatch Defaults

Hatch Pitch	433.58
Hatch Width	127.00
Copper Percentage	50.00

Use the Hatch Defaults tab to specify the default values for Hatch Pitch and Width and Copper Percentage when setting a plane to hatched (see Hatch Configuration.)

Rebuild and Calculate Structures

These options control the way that the Controlled Impedance structure parameters are updated from the stack up. When new structures are added or the Rebuild and Calculate option is selected, Speedstack will update all structures based on the selections below. Default : All options selected.

- Substrate Height (H n)
- Substrate Dielectric (Er n)
- Trace Thickness (T1)
- Coating Above Substrate (C1)
- Coating Dielectric (CEr)

The Rebuild and Calculate Structures tab allows the designer to specify which parameters are included when controlled impedance structures are recalculated after modifying the stack.

Manufacturing Constraints

The Manufacturing Constraints options consist of a collection of manufacturing capabilities, minimum gaps and trace widths, buried and blind via and trace aspect ratios, drill aspect ratios, etc. that can be applied during design rule checking (see the DRC tab detail below.)

Manufacturing Tests (Tools | Manufacturing Constraints)

Active Constraint : Polar Microns

- Min. Trace Width
- Min. Gap Width

Aspect Ratios

- Mechanical Drill
- Buried Laser Microvia
- Blind Laser Microvia
- Trace
- Resin Starvation

They will normally refer to differing levels of technology offered by one or more PCB manufacturers for a range of prices. The required information (shown in the example below) can normally be obtained from the manufacturer.

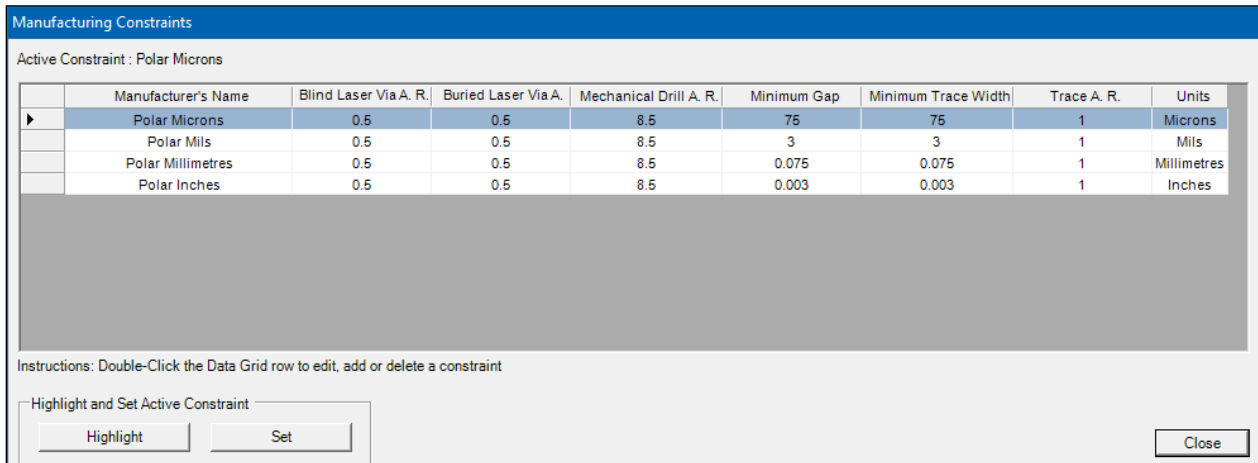

Click the Highlight button to highlight the current active constraint; to apply a new constraint select the constraint row and click Set.

Editing and adding constraints

To modify a constraint or add a new constraint, double click within the constraint row to be edited. Modify each setting as required; click Done to confirm settings and close the dialog.

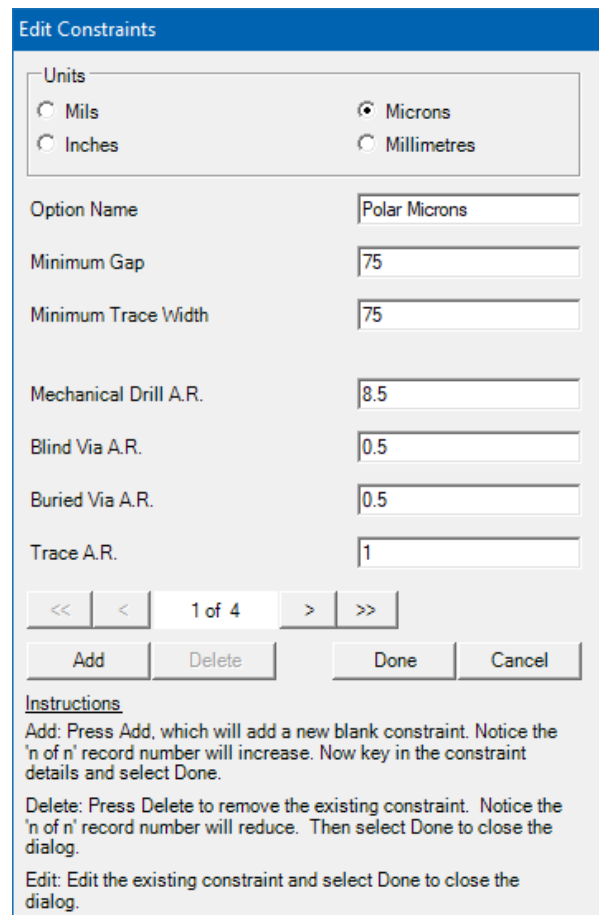

To add a new constraint, click the Add button, fill in the settings fields and click Done to finish. The new constraint will be added to the table of current constraints. Click the Delete button to remove the constraint from the list.

Set Target Stackup Thickness/Enable Finishing

Set the Target Stackup Thickness and tolerances via the dialog below.

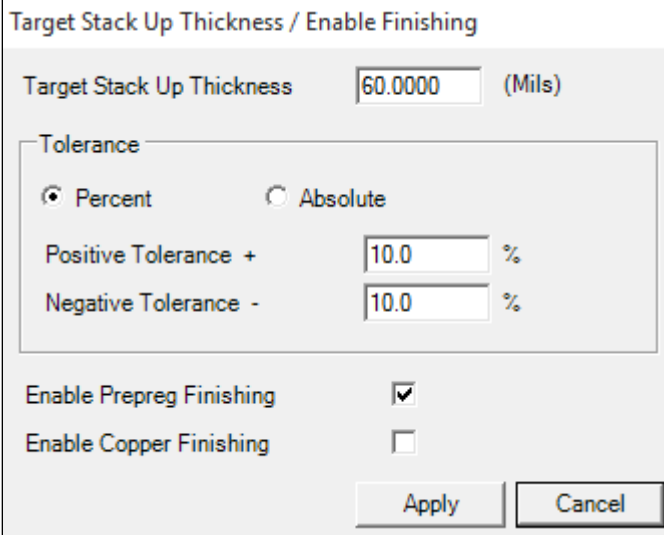

Target Stack Up Thickness / Enable Finishing

Target Stack Up Thickness (Mils)

Tolerance

Percent Absolute

Positive Tolerance + %

Negative Tolerance - %

Enable Prepreg Finishing

Enable Copper Finishing

Tolerance may be set in terms of percentage or absolute values:

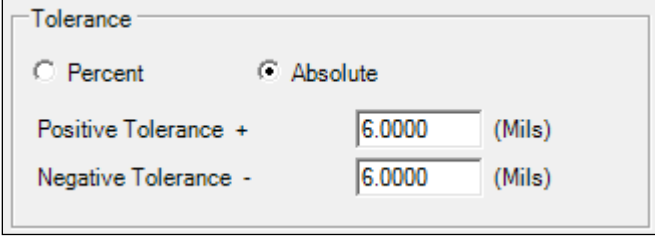

Tolerance

Percent Absolute

Positive Tolerance + (Mils)

Negative Tolerance - (Mils)

Note that positive and negative tolerance values can be set independently. The values should reflect the currently selected units.

To enable prepreg and/or copper finishing tick the associated check boxes. Click Apply.

Note: Unchecking the Enable Finishing options disables the Apply and Reset Finishing buttons. Note that these buttons are only available in Materials Library Mode – they are disabled in Virtual Material Mode.

Finishing Options

From the Tools menu choose the Set Finishing Method command to display the set finishing corrections dialog.

Speedstack offers two methods: *Copper Coverage Method* and *Simple Percentage Method*.

Note: The two methods of finishing, Copper Coverage and Simple Percentage, are not compatible with each other. The Copper Coverage method requires that the finished thickness of prepregs be entered in the material library; that value stays locked in the stack unless the Simple Percentage method is set up; if Reset Finishing is then clicked the finished thickness reverts to the base thickness.

Prior to switching between the Copper Coverage and Simple Percentage finishing methods use the Reset Finishing icon to return the stackup to its unpressed state.



Reset Finishing

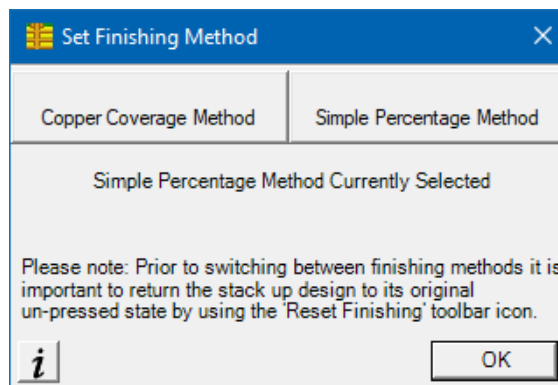

Each method requires that the amount of copper to be added where plating is required be set. In addition, where the Excess Resin design rule check is used the minimum acceptable value must be set.

Simple Percentage Method

Use the Simple Percentage Method to set the percentage of prepreg base height, which will be used to determine the isolation distance. The percentage is set for each electrical layer type pair.

Specify the IPC-6011 Copper Finishing Class and plating thickness. Click Edit to specify the Class name and value

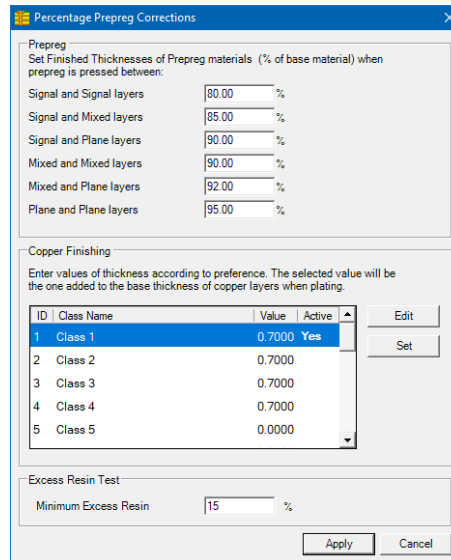

Click Set to activate the class.

Copper Coverage method

The Copper Coverage method allows the user to specify the amount of copper that will be embedded into the prepreg. The greater the copper coverage the smaller the amount of copper that is embedded.

This value can be *set by layer type* – as a single value for each electrical layer type, or *proportional to coverage* – the amount of copper embedded will be calculated on an electrical layer by layer basis dependent upon the copper coverage for the layer set in the layer’s Properties window.

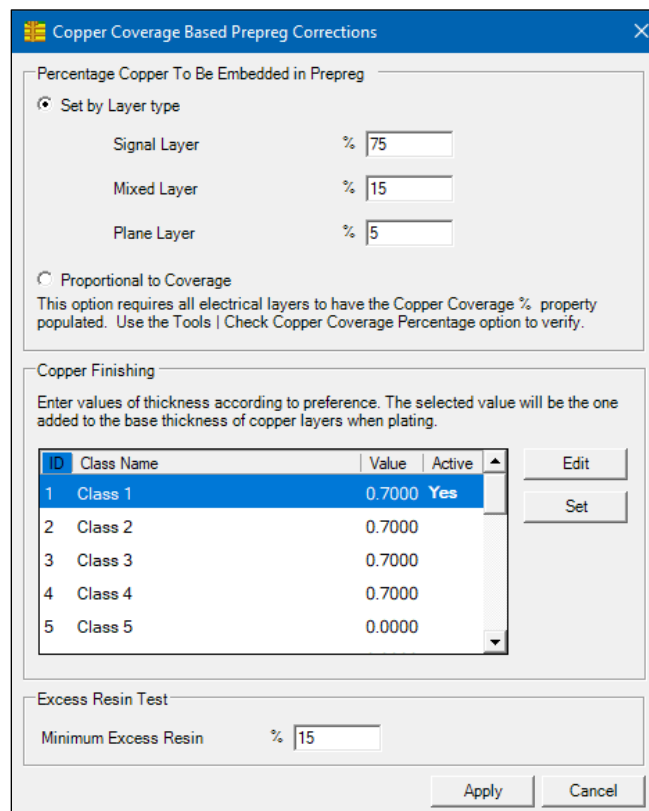

Note: Choosing Proportional to Coverage requires all electrical layers to have the copper coverage percentage property populated. (Right click each layer and choose Properties to view its current setting.)

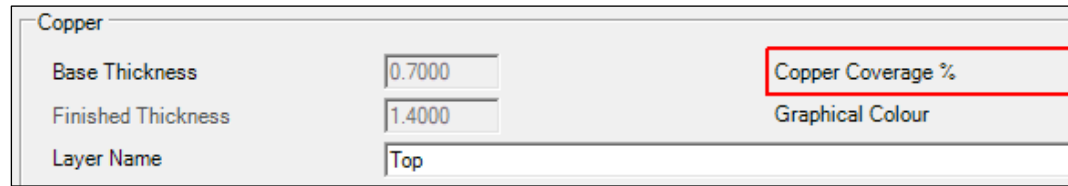

To verify all the layers in the stackup use the *Check Copper Coverage Percentage* command (see below.)

Specify the IPC-6011 Class and plating thickness.

Checking Copper Coverage percentage

Use Check Copper Coverage Percentage to verify that the copper coverage percentage has been set for each layer. This option can be selected to determine which electrical layers, if any, have a Copper Coverage Percentage of 0.

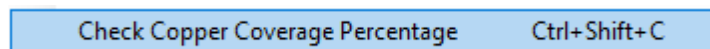

Speedstack displays a message dialog listing the layers where the Copper Coverage Percentage is set to 0.

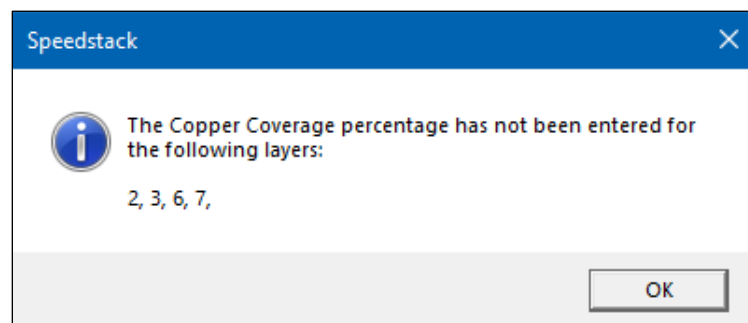

Virtual Material mode

The Virtual Material Mode command toggles between Virtual Material and Material Library modes.

Note: Switching to Virtual Material Mode disables the Apply and Reset Finishing buttons.

Note: Virtual Material mode and the Simple Percentage method of finishing are not compatible. Speedstack displays the message below if the two are selected simultaneously.

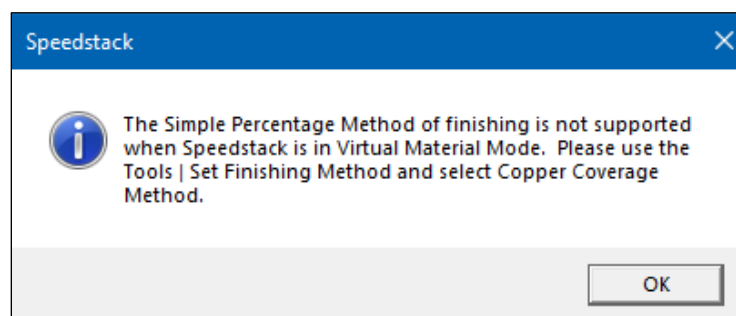

Working with external utilities

Speedstack can call an external program / utility / script via the External Utilities menu options. The menu items are configured via Configuration Options|External Utilities.

1	<input type="text"/>	Choose	Clear
2	<input type="text"/>	Choose	Clear
3	<input type="text"/>	Choose	Clear
4	<input type="text"/>	Choose	Clear
5	<input type="text"/>	Choose	Clear

To specify a program click Choose and navigate to the program and click Open. The program will be added to the External Utility menu.

Speedstack main toolbar

The Speedstack toolbar comprises shortcut links to the most popular commands.



Note: toolbar buttons will be enabled/disabled depending on whether Speedstack is performing stack editing or controlled impedance calculations. Pause the mouse over each tool button to display the tool's screen tip

File operations



Create new stackup



Library mode



Virtual Material mode



Stackup Wizard

Stack building operations



Symmetrical Mode off



Symmetrical Mode on



Mirroring Mode



Add layer to the stackup

Click to select the layer type. The list of layer types is displayed in the associated sub-menu.

Layers available include:

Foil	Add foil layer to the stackup
Core	Add core layer
RCC	Add resin coated copper layer
Non-Copper Core	Add non-copper core
Prepreg	Add prepreg layer

Soldermask	Add solder mask
Flexible core	Add flexible core layer
Bondply	Add bond ply adhesive
Adhesive	Add Adhesive
Coverlay	Add coverlay layer
Ident	Add screened ident layer
Peelable	Add peelable mask



Add mechanical/laser drill between layers

Editing the stackup



Delete selected stackup material or drill



Swap selected material

Note: the Copy and Paste buttons below are only enabled for the Stack Editor and DRC tabs – they are disabled for the Controlled Impedance and CI Results tabs.

Copying and pasting materials



Copy material of the selected layer



Paste material above selected layer



Paste material below selected layer



Copy material properties



Paste material properties

Changing plane types



Set the selected electrical layer as a signal layer



Set the selected electrical layer as a plane



Set the selected electrical layer as a mixed signal/plane layer



Set the selected electrical layer as a hatched plane

Note: Move Selected Layer buttons (below) are only enabled for the Stack Editor and DRC tabs – they are unavailable for the Stackup Editor in Grid View and disabled for the Controlled Impedance and CI Results tabs.



Move selected layer up one layer



Move selected layer down one layer



Display properties dialog for the selected layer or drill

Applying finishing



Apply finished thickness



Reset finished thickness

Note: Apply and Reset Finishing buttons are enabled only for Materials Library Mode with the Prepreg and Copper Finishing Options checked (see Set Target Stack UpThickness / Finishing Options) – they are disabled for the Virtual Materials Mode.

Changing the stackup view



Display 2-dimensional view



Display 3-dimensional view



Grid View



Proportional Graphics View

Managing the materials library



Go To/Display materials library

Exchanging data with the Si8000m or Si9000e Field solver



Copy controlled impedance data to field solver



Paste controlled impedance data from field solver



Copy to Si8000m or Si9000e Project

Creating and editing stackups (Virtual Material mode)

Material Library and Virtual Material modes

Speedstack provides the option of switching easily between Material Library and Virtual Material modes, Virtual material mode allows the stack designer to build and experiment with stackups without requiring real materials to be entered into a materials library.

In Virtual Material mode the Stackup Wizard allows rapid entry of stack details, the number of layers, overall board thickness, plane layers, solder mask and copper thickness. Speedstack will then build a stack to the specified board thickness by distributing the dielectric regions equally. If a preferred core thickness is specified Speedstack will maintain the dielectric thickness for core regions but equally distribute prepregs to reach the target board thickness.

This section will describe the steps to construct an 8-layer, symmetrical FR-4 stack to the specification below using Speedstack's Virtual Material mode.

Thickness:	60 mil
Signal layers:	1, 3, 6, 8
Plane layers:	2, 4, 5, 7
Er:	4.2
Preferred core thickness:	8 mil
Copper (all layers):	1 oz. / 1.4 mil
LPI Mask:	1 mil
PTH drill passes:	Layers 1 – 8
Laser microvia passes:	Layers 1 – 2, 8 – 7
Impedance structures:	SE 50 Ohm Layer 1, Diff 100 Ohm Layer 1

Using the Stackup Wizard (Virtual Material mode)

From the Units menu choose Mils/Thou

From the Tools menu toggle Virtual Material Mode On (or toggle the Material Library/Virtual Material mode icon.)



Ensure the Library/Virtual Material mode icon indicates Virtual Material mode.

From the File menu chose New|Stackup Wizard.

The Stackup Wizard supports up to 128 layers

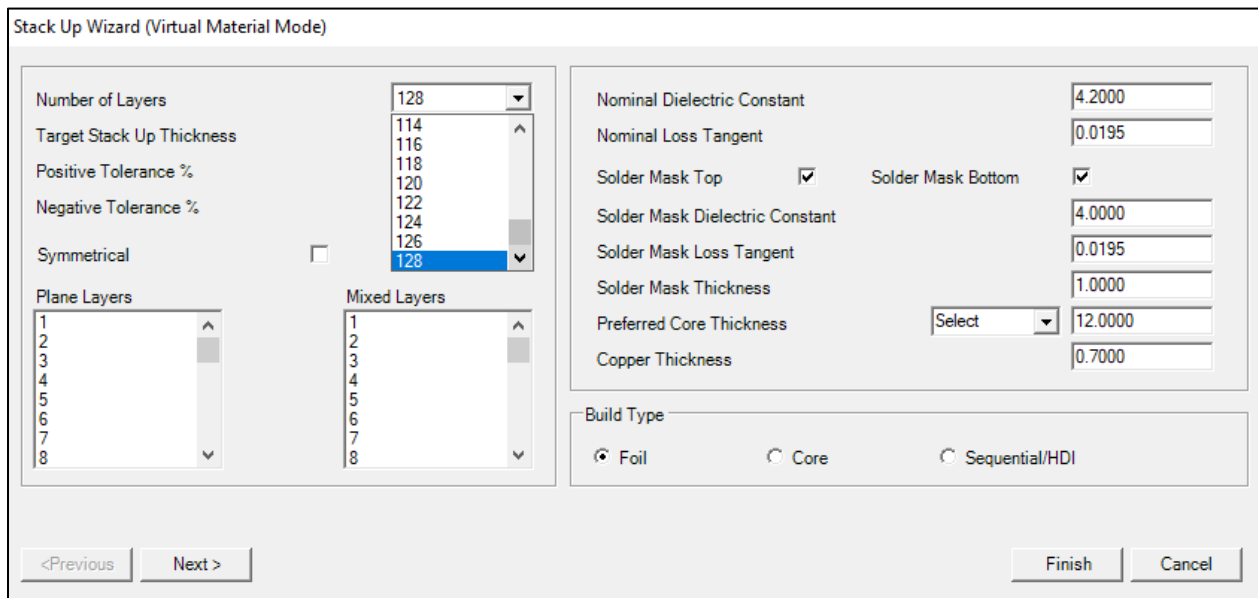

In the example below the Stack Editor displays the last few layers of a 128 layer stack

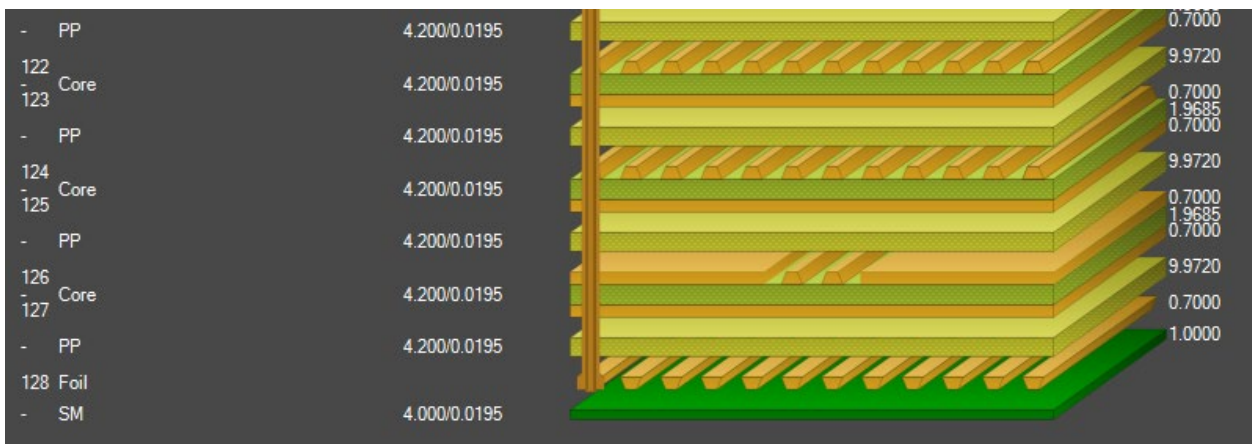

Use the Zoom Extents command to view the entire stack; navigate quickly to the layer to be edited with the mouse wheel zoom.

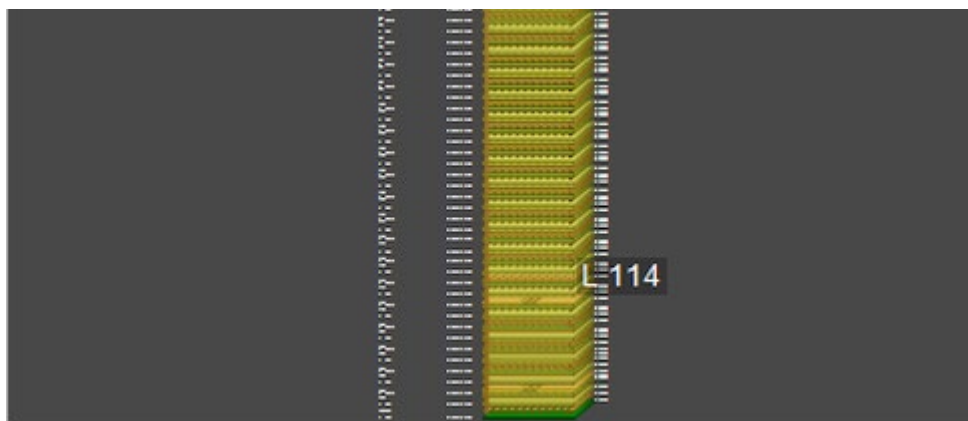

Setting basic stack data

Consider constructing an 8-layer stackup. Supply the parameters for the stackup as shown in the Stackup Wizard dialog below.

Stack Up Wizard (Virtual Material Mode)

Number of Layers	8	Nominal Dielectric Constant	4.2000
Target Stack Up Thickness	60	Nominal Loss Tangent	0.0195
Positive Tolerance %	10	Solder Mask Top	<input checked="" type="checkbox"/>
Negative Tolerance %	10	Solder Mask Bottom	<input checked="" type="checkbox"/>
Symmetrical	<input checked="" type="checkbox"/>	Solder Mask Dielectric Constant	4.0000
Plane Layers	1 2 3 4 5 6 7 8	Solder Mask Loss Tangent	0.0195
Mixed Layers	1 2 3 4 5 6 7 8	Solder Mask Thickness	1.0000
		Preferred Core Thickness	Select 8
		Copper Thickness	0.7000

Build Type

Foil Core Sequential/HDI

<Previous Next > Finish Cancel

Step through the Stackup Wizard:

- Choose the number of layers
- Specify the board target thickness
- Specify whether the stackup will be symmetrical
- Designate plane and mixed layers.
Note the symmetrical arrangement of the chosen plane layers
- Supply the other material parameters. Note that when in Symmetrical mode, the Solder Mask Bottom checkbox (shown greyed out) matches Solder Mask Top when its checkbox is ticked.
- Choose the build type, foil, core or sequential HDI

Foil and Core builds

This most basic 8-layer stackup is the *foil build*, with a foil on the outer layer of the stack; it is the most common build for even higher layer count boards.

Another common type of 8-layer stackup – with core materials on the outer layers – is called a *core build*.

Core builds are typically used in microwave applications where expensive microwave materials are laminated together with a lower cost internal bonding layer.

Click Finish to display the stackup or Next to add drills.

The graphics below illustrate typical 8-layer foil and core builds before drills are added.

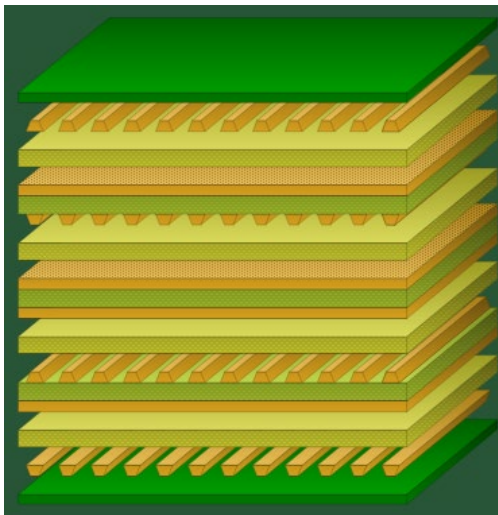

8-layer foil build

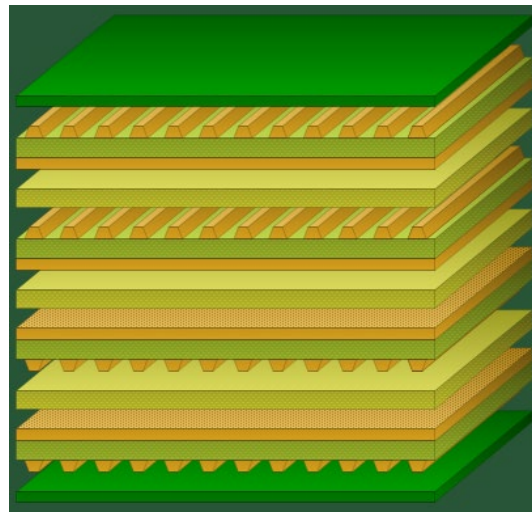

8-layer core build

Sequential HDI builds

Choosing a Sequential HDI build displays the Define Sequential Build dialog where the HDI build may be constructed.

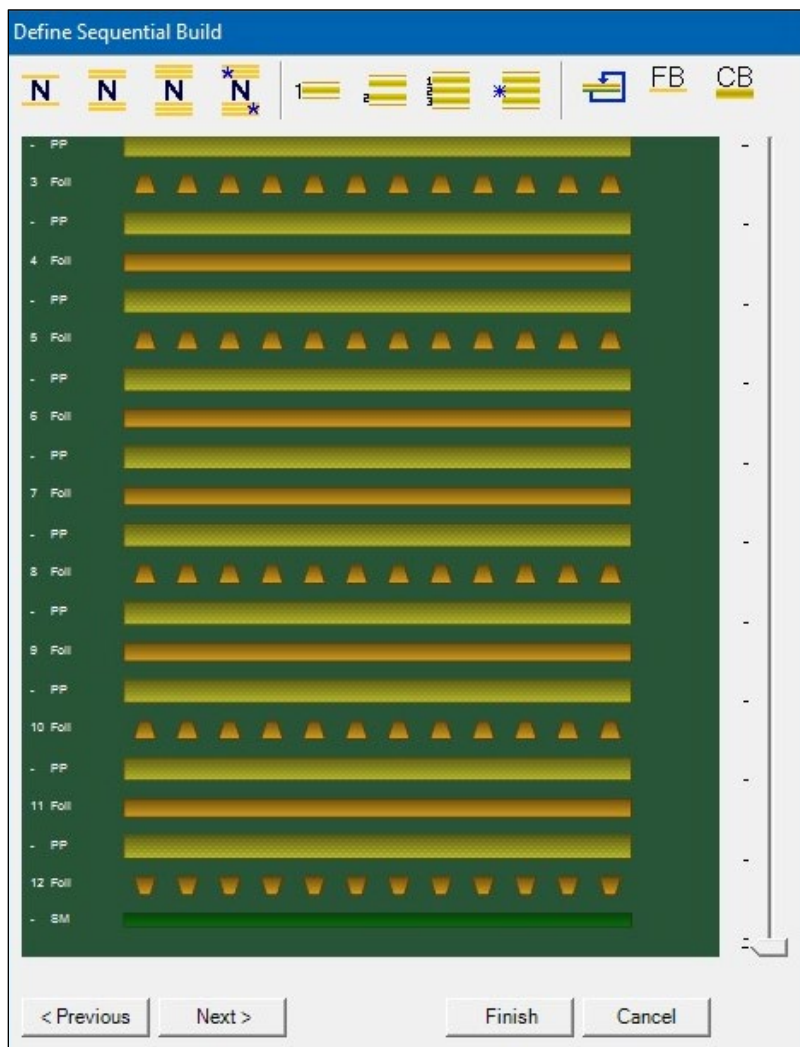

The structure of the HDI is by construction type. (See IPC-2315, IPC-2226.) The Speedstack wizard supports Types I, Type II, and Type III as shown below



Type I Stack



Type II Stack



Type III Stack



Set number of foils added to foil build



Foil build sub-section with one core



Foil build sub-section with two core



Foil build sub-section with three core



Set number of cores in foil build sub-section



Reset to foils and preregs



Reset to foil build



Reset to core build

Use the toolbar to define the sequential HDI build.

Click Next to add drills or Finish to add the (optional) stackup file properties and display the stackup. View the stackup sequence in the Navigator; right click and choose HDI Build|Sequential Plan.

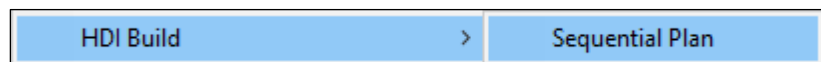

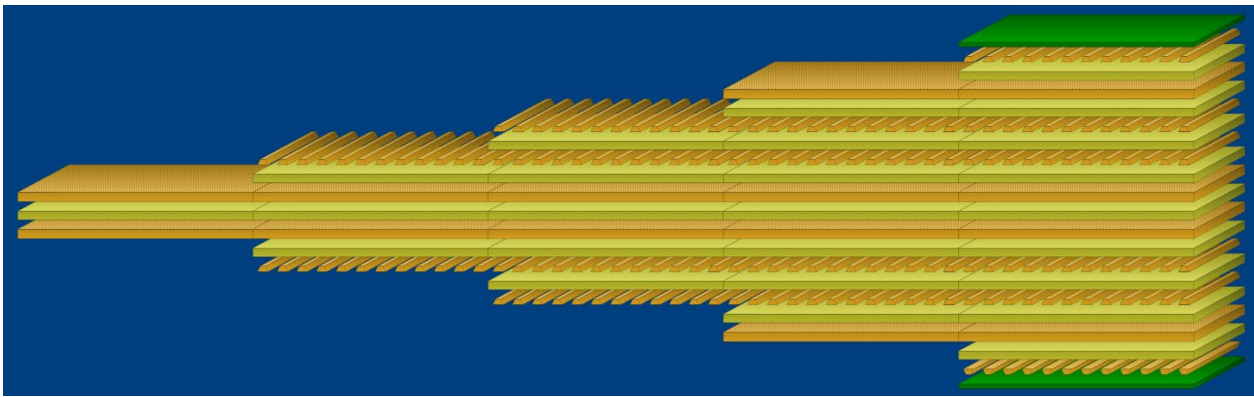

Adding drills

Drill information is assigned to drill columns (up to 11 columns are available) Select Column 1 and specify the First Electrical Layer as Layer 1 and the Second Electrical Layer as Layer 8; choose Mechanical, Through Plated with No Fill and click Add to add the first drill to the stack.

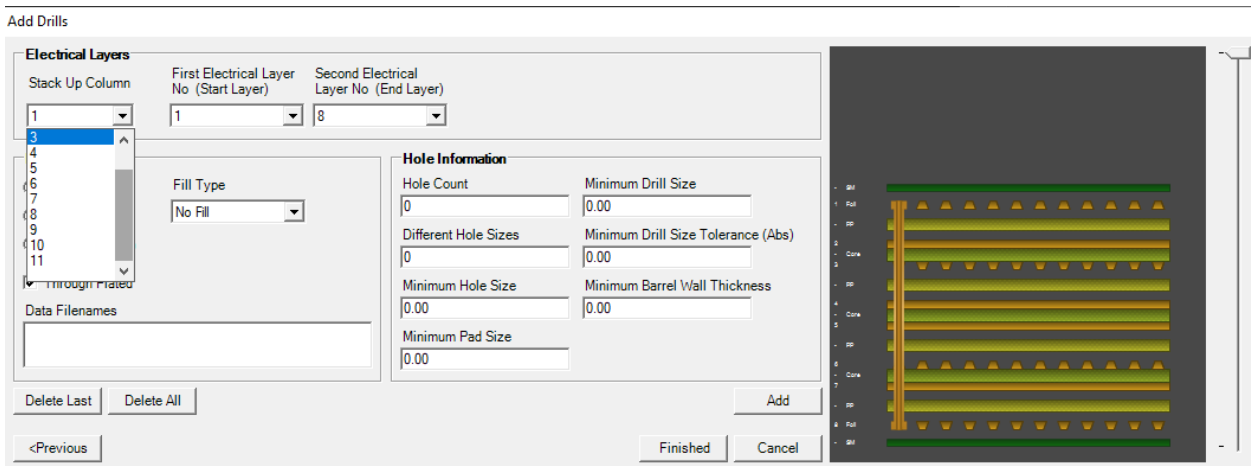

Adding microvias

Choose Column 2, specify the First Electrical Layer as 1 and the Second Electrical layer as 2; choose Laser with No Fill and click Add. Repeat the process to add another microvia to Column 2 between electrical layers 8 and 7 (shown below.)

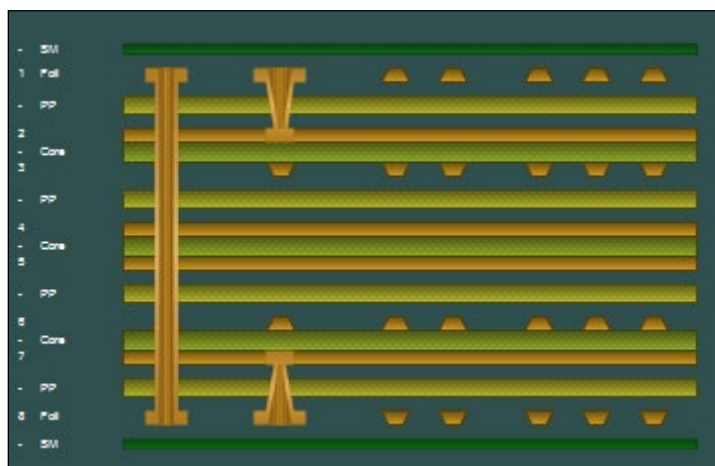

Click Finished.

The Stackup Wizard displays the New Stackup File Properties dialog; enter the (optional) stackup properties.

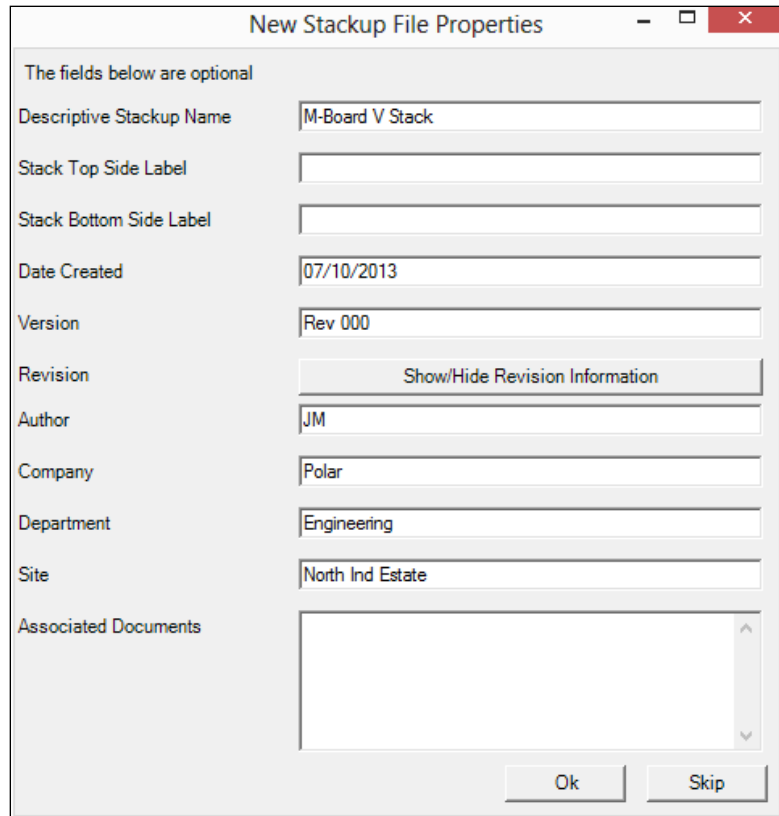

Click OK to close the dialog and edit the stack. Speedstack builds the stack to achieve the specified board thickness.



See 2D View

Click the See 2D View button to assist in visualisation while editing the stack.

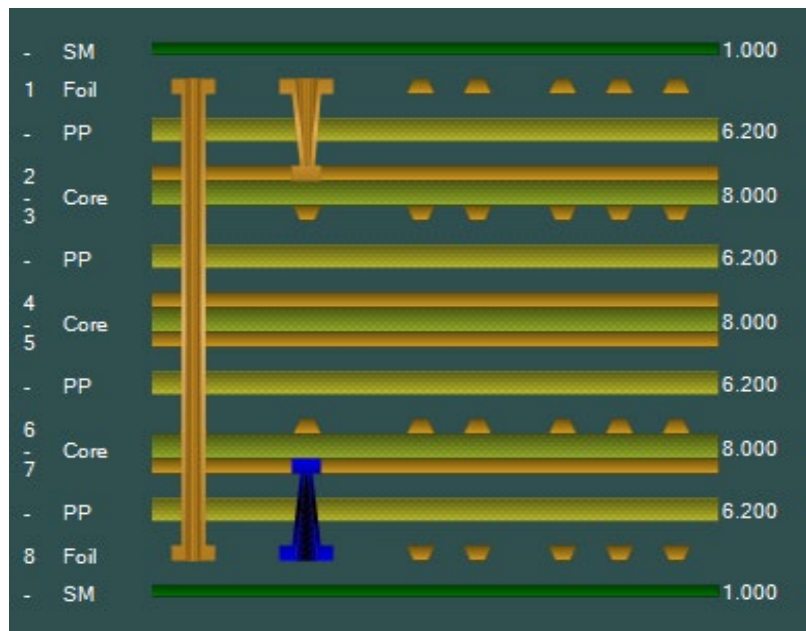

Use the View menu to zoom in and out of the stack.

Zoom In
Zoom Out
Zoom Extents
Default View

Hint: Click the mouse wheel in the Stack Editor (Zoom Extents) to view the entire stack.

The Stackup Editor displays summary information for the whole stack and for items within the stack as they are selected.

Field	Value
Electrical Layer Count	8
Stack Up Cost	0.00
Copper Thickness	11.0236
Dielectric Thickness	51.9685
Solder Mask Thickness	1.9685
=====	=====
Target Stack Up Thickness	62.9921
Stack Up Thickness	62.9921
Stack Up Thickness with Soldermask	64.9606
=====	=====

Field	Value
First Electrical Layer No	8
Second Electrical Layer No	7
Mechanical Drill	False
Laser Drill	True
Fill Type	No Fill
Data Filenames	
Hole Count	0
Different Hole Sizes	0
Minimum Hole Size	0.001
Minimum Allowable Hole Size	15.2000

Editing the stack

With the “virtual” stack in the Stack Editor the stack can be changed as required.

Changing material properties

To change the properties of a material, right click the material in the stack and choose Properties; fill in the text fields with the associated information and click Apply. Most

material properties can be changed, including the material descriptions, base and finished thickness, dielectric constants, drill parameters along with the graphical colours.

Choosing Symmetrical mode



Symmetrical OFF



Symmetrical ON

Stackups are often designed symmetrically to prevent warping and twisting – using similar materials in the top and bottom halves of the stack.

Clicking the Symmetrical button will toggle the Symmetrical mode on or off. In Symmetrical mode the stack editing functions will process materials in the upper and lower halves of the stack simultaneously.

Changing the material description

In this example stack, ensure symmetrical mode is selected then right click the solder mask material in the stack to display the Solder Mask Properties dialog.

Change the Solder Mask Description to Liquid Photo Imageable (LPI).

The change on the Description in both solder masks is reflected in the Editor window.

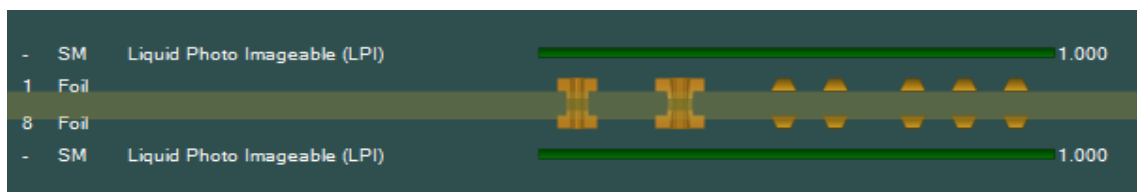

Changing electrical layers

Electrical layer types may be changed from plane to signal, mixed and hatched. Right click the layer to be changed and choose from Signal, Plane, Mixed or Hatched.



Speedstack will take the designated layer type into consideration when adding controlled impedance structures.

Setting hatched planes



Set Layer to Hatched Plane

With the XFE option Speedstack supports hatched planes, implementing the same crosshatch calculation technique used in the Si8000m / Si9000e. If a crosshatch plane is required click Set Layer to Hatched Plane –use the Hatch Configuration dialog to set hatch pitch and width or set the hatch width by percentage copper area. Click Apply.

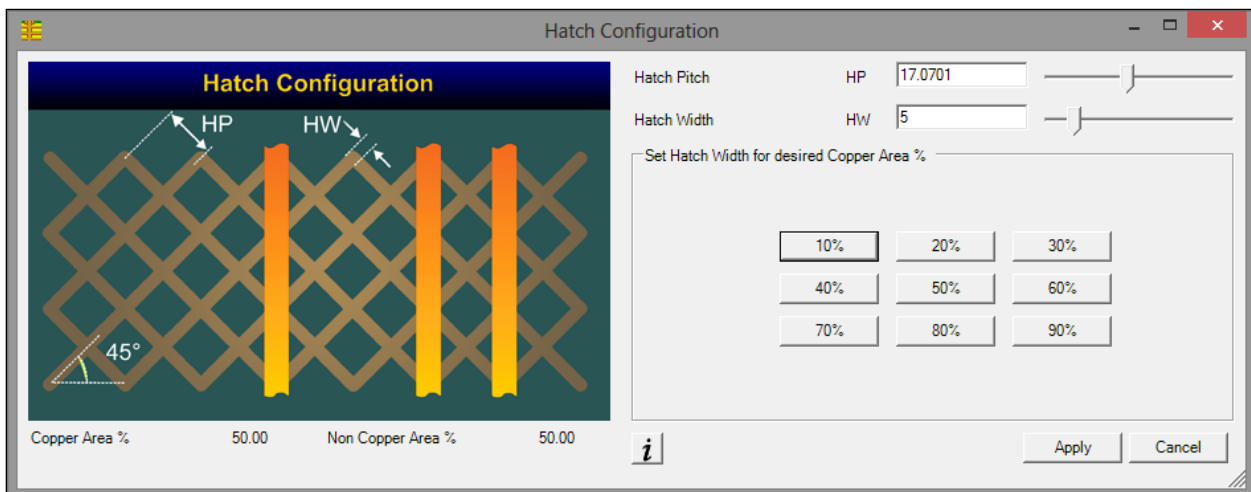

Adding controlled impedance structures

To add controlled impedance structures, click the Controlled Impedance tab, select the copper layer (in this example, Layer 1) and click the Add New Structure button.

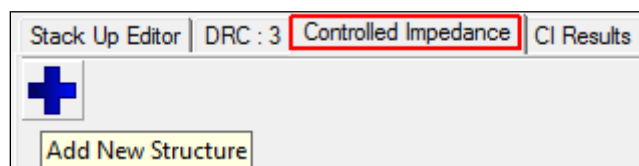

Speedstack suggests structures valid for the layer based on the plane layer types.

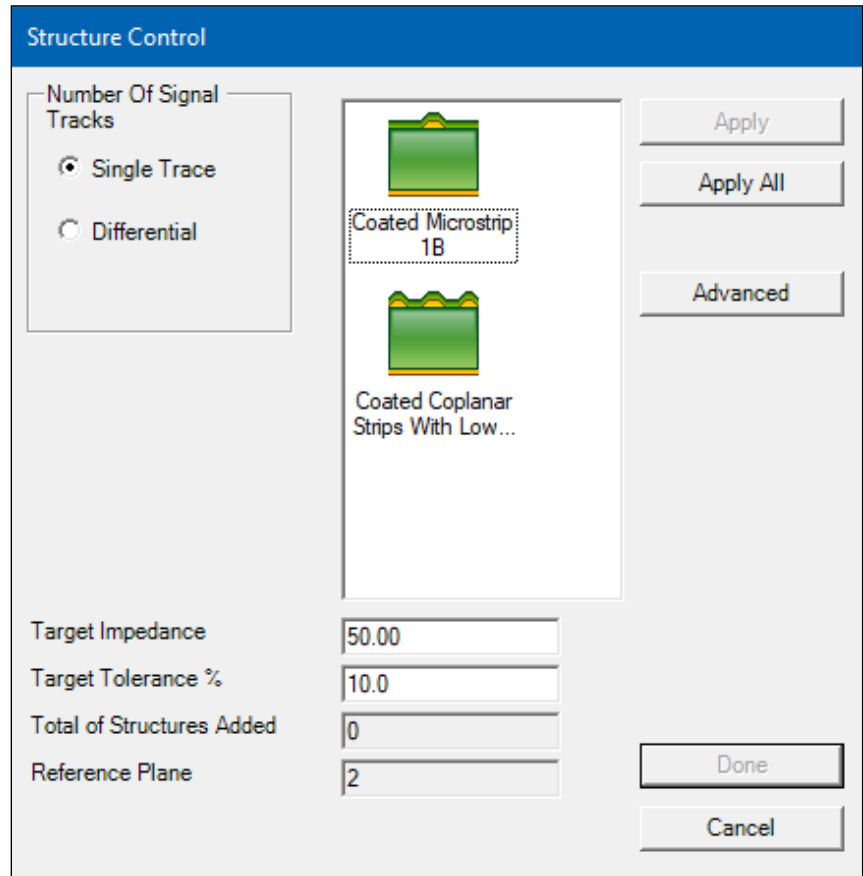

For this example, choose a 50 Ohm single ended coated microstrip; leave the tolerance at 10%; click Apply then Done.



Structure on Layer

The new structure is shown in the stack, highlighting the materials employed by the structure.



Adding a controlled impedance structure will activate the Controlled Impedance toolbar.

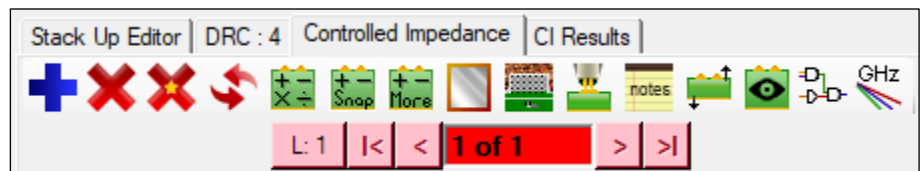

The structure appears in the Controlled Impedance panel, along with its parameters.

Stack Up Editor | DRC : 4 | Controlled Impedance | CI Results

L: 1 | < | < | 1 of 1 | > | >

Substrate 1 Height	H1	3.0000
Substrate 1 Dielectric	Er1	4.2000
Lower Trace Width	W1	9.8425
Upper Trace Width	W2	9.7244
Trace Thickness	T1	1.4000
Coating Above Substrate	C1	1.0000
Coating Above Trace	C2	1.0000
Coating Dielectric	CEr	4.0000
Impedance		Zo
Target Impedance		50.00
Target Tolerance %		10.00

Calculating the structure impedance

Parameters calculated from the stack materials, such as the substrate height and dielectric are read only and shown greyed out; other parameters may be edited. If the editable parameters are known they may be entered directly.

For example, modify W1 to read 4.5 and W2 to read 3.5 and click the Rebuild and Calculate All Structures.

The impedance is calculated as 50.09 Ohms

Displaying more calculations



More Calculations

Click the More Calculations button – more calculations provide additional field solver results for the selected structure within the stack.

Results displayed depend upon the structure – single-ended or differential.

Single ended calculations include

- impedance,
- delay,
- inductance and capacitance,
- effective dielectric constant and
- velocity of propagation

See single-ended dialog below

More Calculations			
Impedance	Zo	<input type="text" value="50.087"/>	<input type="button" value="Close"/>
Delay (ps/in)	D	<input type="text" value="156.701"/>	
Inductance (nH/in)	L	<input type="text" value="7.849"/>	
Capacitance (pF/in)	C	<input type="text" value="3.129"/>	
Effective Dielectric Constant	EEr	<input type="text" value="3.421"/>	
Velocity of Propagation (CITS)	Vp	<input type="text" value="0.541"/>	

More single-ended calculations

Differential calculations include:

- differential impedance,
- odd mode delay,
- odd mode and even mode impedance,
- common mode impedance,
- effective dielectric constant,
- velocity of propagation,
- near-end crosstalk and
- coupling percentage

See differential dialog below.

More Calculations			
Differential Impedance	Zdiff	<input type="text" value="99.673"/>	<input type="button" value="Close"/>
Delay (Odd Mode) (ps/in)	D	<input type="text" value="152.561"/>	
Odd Mode Impedance	Zodd	<input type="text" value="49.837"/>	
Even Mode Impedance	Zeven	<input type="text" value="55.725"/>	
Common Mode Impedance	Zcommon	<input type="text" value="27.863"/>	
Effective Dielectric Constant	EEr	<input type="text" value="3.242"/>	
Velocity of Propagation (CITS)	Vp	<input type="text" value="0.555"/>	
Near-End Crosstalk (NEXT)	Kb	<input type="text" value="2.7891E-02"/>	
Coupling Percentage	CP	<input type="text" value="2.789"/>	

More differential calculations

Goal Seeking the target impedance



Goal Seek button

Speedstack can adjust one or more structure parameters to achieve a specified target impedance. Leave the Target Impedance at 50 Ohms and click the Goal Seek button

From the Set Up Goal Seek dialog choose W1/W2 only

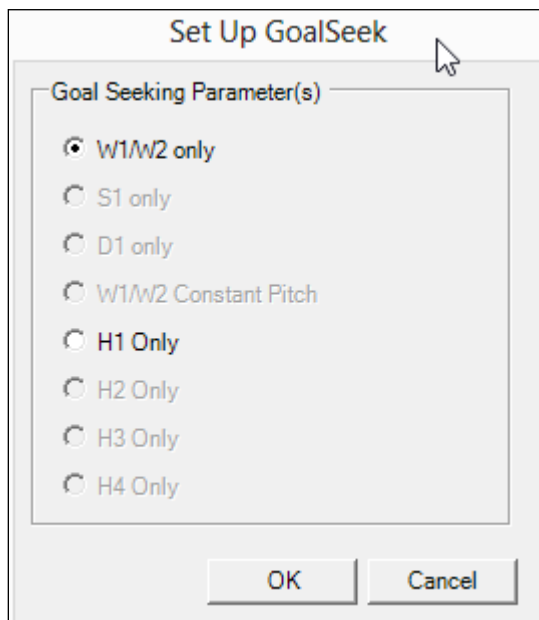

Click OK – Speedstack adjusts trace width (below) to achieve the target 50 Ohm impedance.

Substrate 1 Height	H1	6.2000
Substrate 1 Dielectric	Er1	4.2000
Lower Trace Width	W1	10.7037
Upper Trace Width	W2	9.7037
Trace Thickness	T1	1.4000
Coating Above Substrate	C1	1.0000
Coating Above Trace	C2	1.0000
Coating Dielectric	CEr	3.0000
Impedance	Zo	50.02
Target Impedance		50.00
Target Tolerance %		10.00

With the impedance in tolerance the navigation buttons display green.

Mirroring structures

This example stack is symmetrical so structures may be copied to the lower half of the stack (i.e. on the lower outer layer.) Click Mirror Structures if Stack Symmetrical.

The impedance structure on Layer 1 is copied to Layer 8.

Rebuilding the stack

During stack editing changes to the stack (for example, inserting prepreg materials into a layer or altering the existing material thickness) will affect the impedance value of one or

more structures. If Speedstack senses that an impedance structure has changed it issues a Rebuild alert.

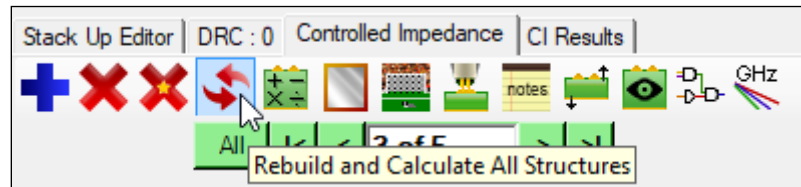

Click Rebuild and Calculate All Structures – Speedstack recalculates the impedance for the new parameters. If the impedance value is out of tolerance the structure browse control changes colour to red.

Virtual Material mode allows the designer to experiment with material properties to examine the effects on impedance structures of different trace widths or dielectric heights, etc. Materials may be added, moved, copied, pasted or removed and the properties of materials changed – Speedstack will sense the changes and allow the “generic” stack to be rebuilt and recalculated.

Creating and editing stackups (Material Library mode)

This section describes creating stackups using the Material Library mode. Stackups may be created manually using the Stackup Wizard or using the editing window. Ensure Tools|Virtual Material Mode is toggled Off.

Using the Stackup Wizard (Material Library Mode)



Stackup Wizard button

The Stackup Wizard guides the user through the process of creating complex stackups in only a few steps. Click the Stackup Wizard button or choose Stackup Wizard from the File|New sub menu. The stackup editing window is cleared and the Stackup Wizard displayed.

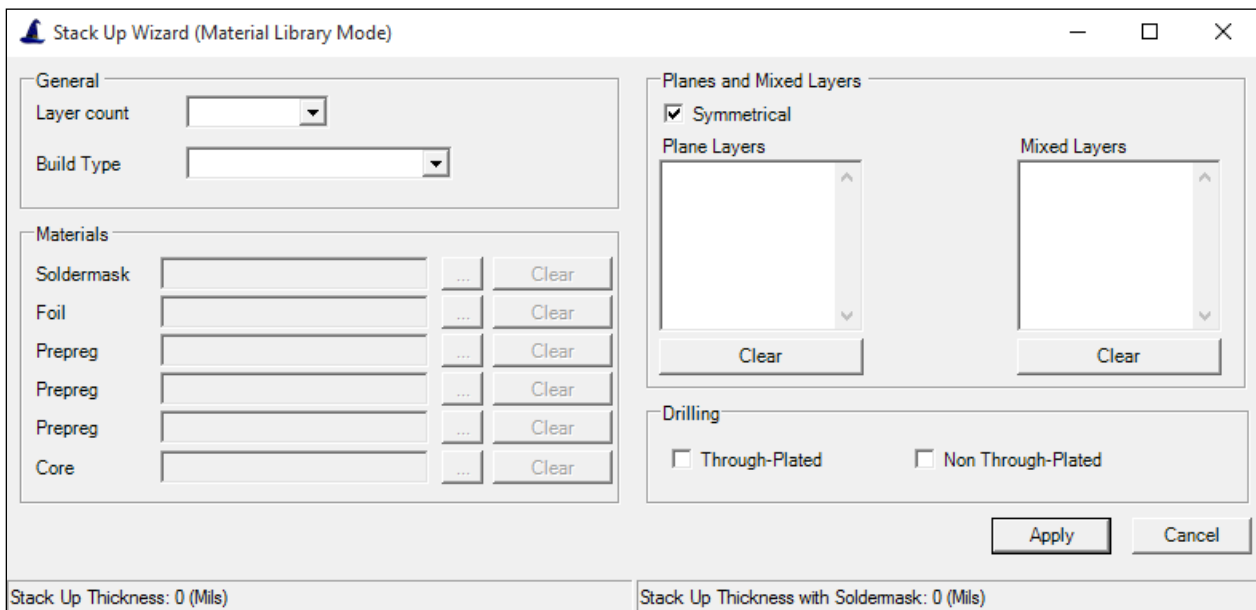

Using the Wizard the user can specify the layer count and build type, stackup materials, planes and drill types in a single operation.

Electrical layer count

Begin by specifying the electrical layer count — up to 64 electrical layers may be specified. Choose the number of layers from the drop down list box.

Build type

Choose the build type (Foil or Core) from the drop down list box. Core builds contain only core materials; most builds will be foil builds — containing internal layers of cores with two outer foils.

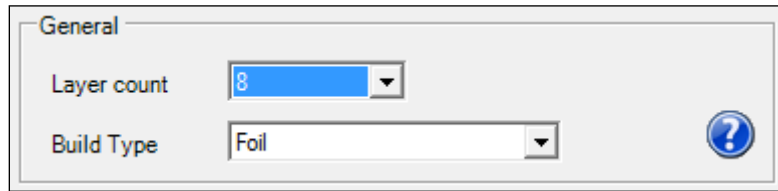

Choosing stackup materials

Note; if Core build type has been specified the Foil material control will be disabled.

The Wizard allows for a stack comprising solder mask, foil, and cores with up to three prepreg materials between.

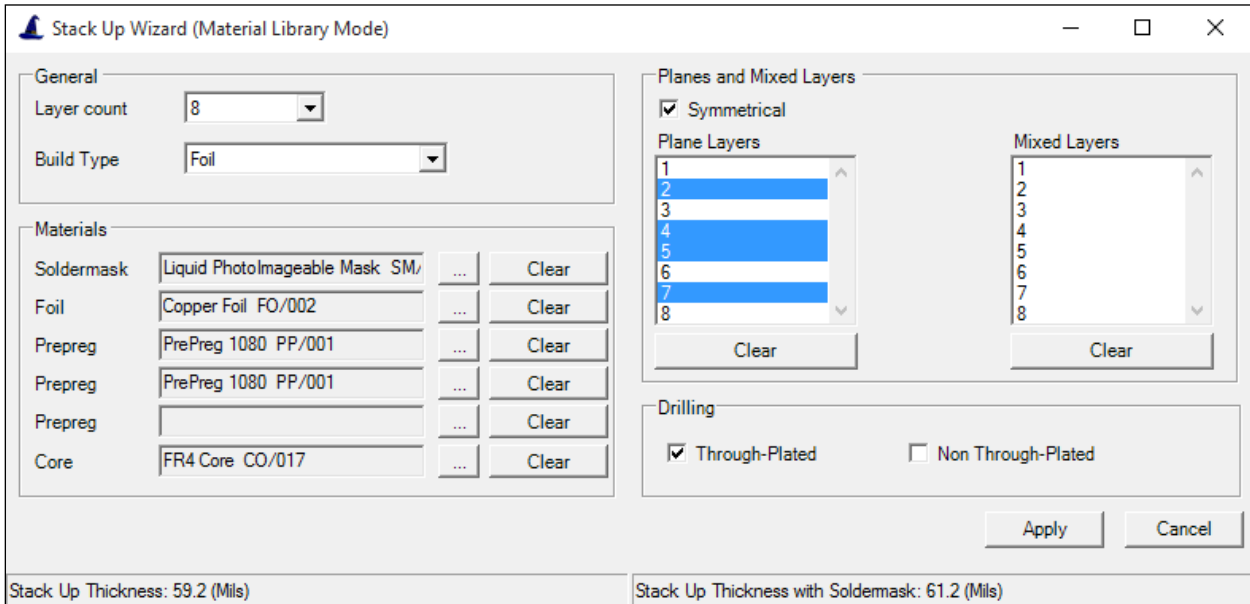

The Wizard displays a running total of the stackup thickness in the Wizard's status bar.

Adding layers



To include a layer (in this example a foil layer) click the Foil Add Material button; the library of foil materials is displayed. Choose the foil material from the list and click the Add Material Above button; the material is added as a foil layer to the stackup.

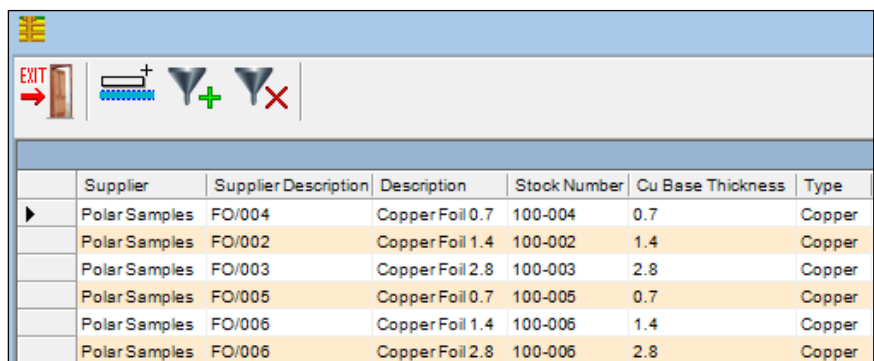

Repeat the procedure for prepreg and core materials and the (optional) solder mask layers. Use the Clear button to remove a layer from the stackup.

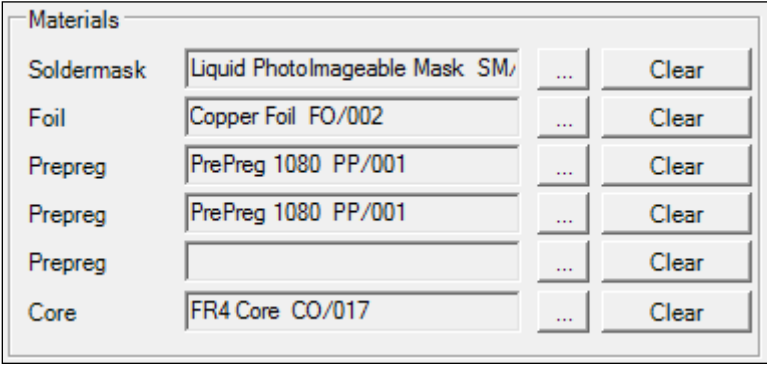

The Materials dialog box contains a table with the following entries:

Material Type	Material Name	Action	Action
Soldermask	Liquid PhotoImageable Mask SM/	...	Clear
Foil	Copper Foil FO/002	...	Clear
Prepreg	PrePreg 1080 PP/001	...	Clear
Prepreg	PrePreg 1080 PP/001	...	Clear
Prepreg		...	Clear
Core	FR4 Core CO/017	...	Clear

Nominating power planes and mixed layers

Use the list boxes to specify planes as power planes or layers as mixed layers. Select all planes as required. To remove a plane from the list select the plane number from the list and click Clear.

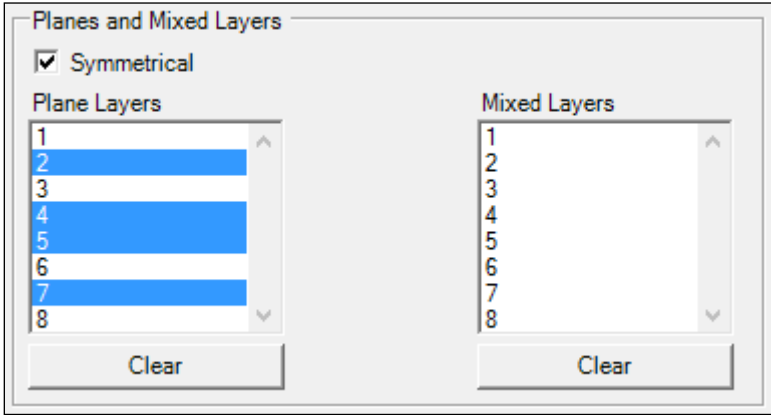

The Planes and Mixed Layers dialog box includes a checked Symmetrical checkbox. It features two list boxes: Plane Layers and Mixed Layers. The Plane Layers list contains items 1 through 8, with items 2, 4, 5, and 7 highlighted in blue. The Mixed Layers list is currently empty. Both list boxes have a Clear button below them.

The dialog above shows Layers 2, 4, 5 and 7 specified as power planes

Adding drill information

To add a drill between electrical layer 1 and the last layer click the Through-Plated and Non-Through-Plated check boxes as required.

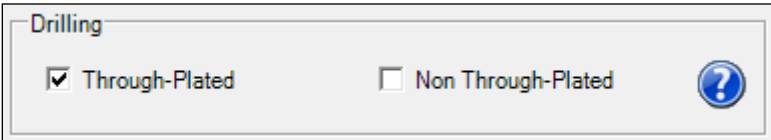

The Drilling dialog box contains two checkboxes: Through-Plated and Non Through-Plated. A help icon (question mark in a blue circle) is located to the right of the Non Through-Plated checkbox.

With all build options specified click Apply to complete the stackup. The finished stackup appears in the Editor window.

The example stack below includes two prepreg materials between layers.

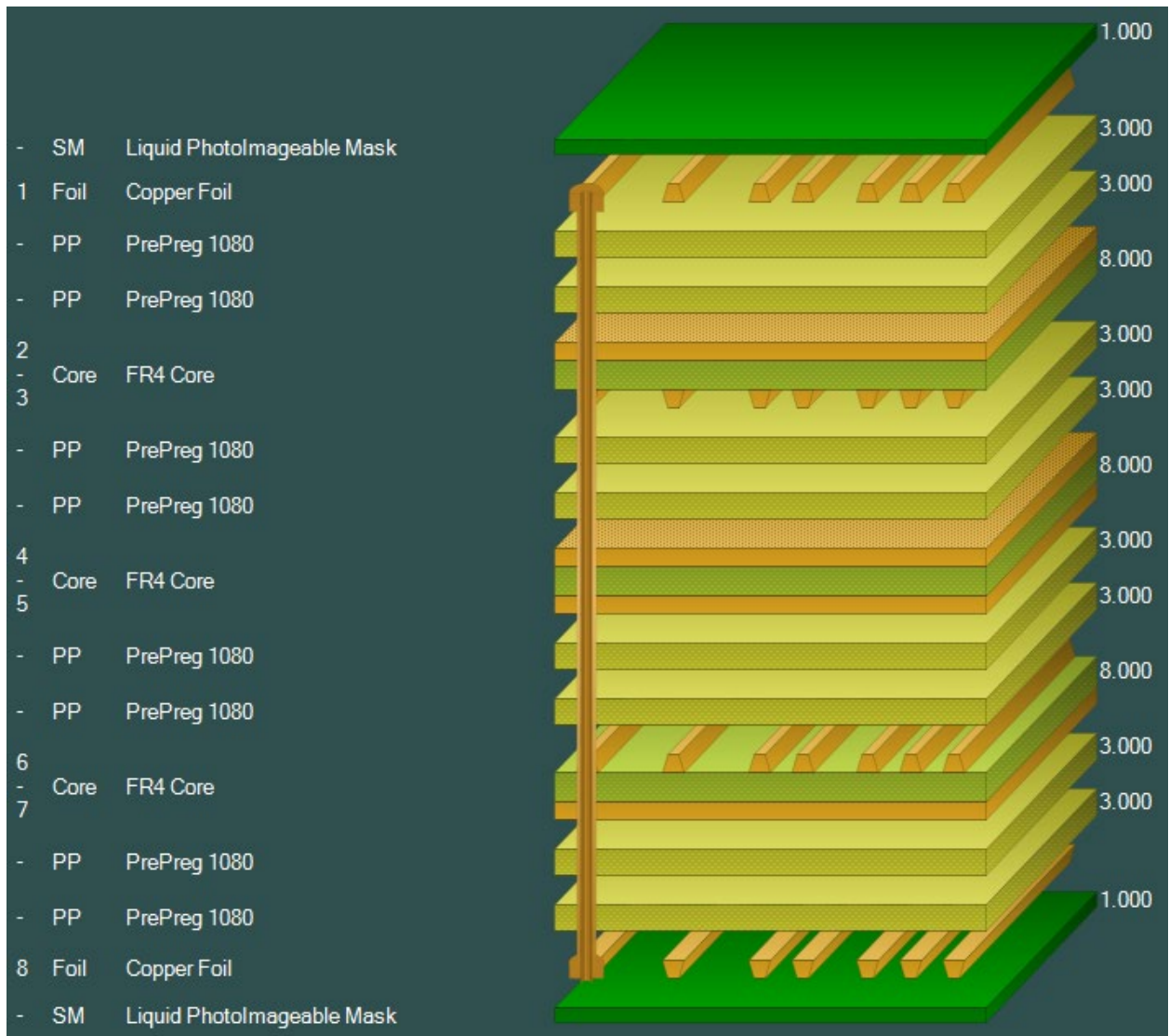

Summary information is shown in the Status Bar and includes the units in use, the target stackup thickness and the stackup thickness without and with soldermask.

Mils/Thous	Target Stack Up Thickness = 60.0000	Stack Up Thickness = 59.2000	Stack Up Thickness with Soldermask = 61.2000
------------	-------------------------------------	------------------------------	--

Changing the stackup view



See 2D View

For many editing operations changes to the stack may be easier to visualize when shown two-dimensionally. Click the See 2D View button

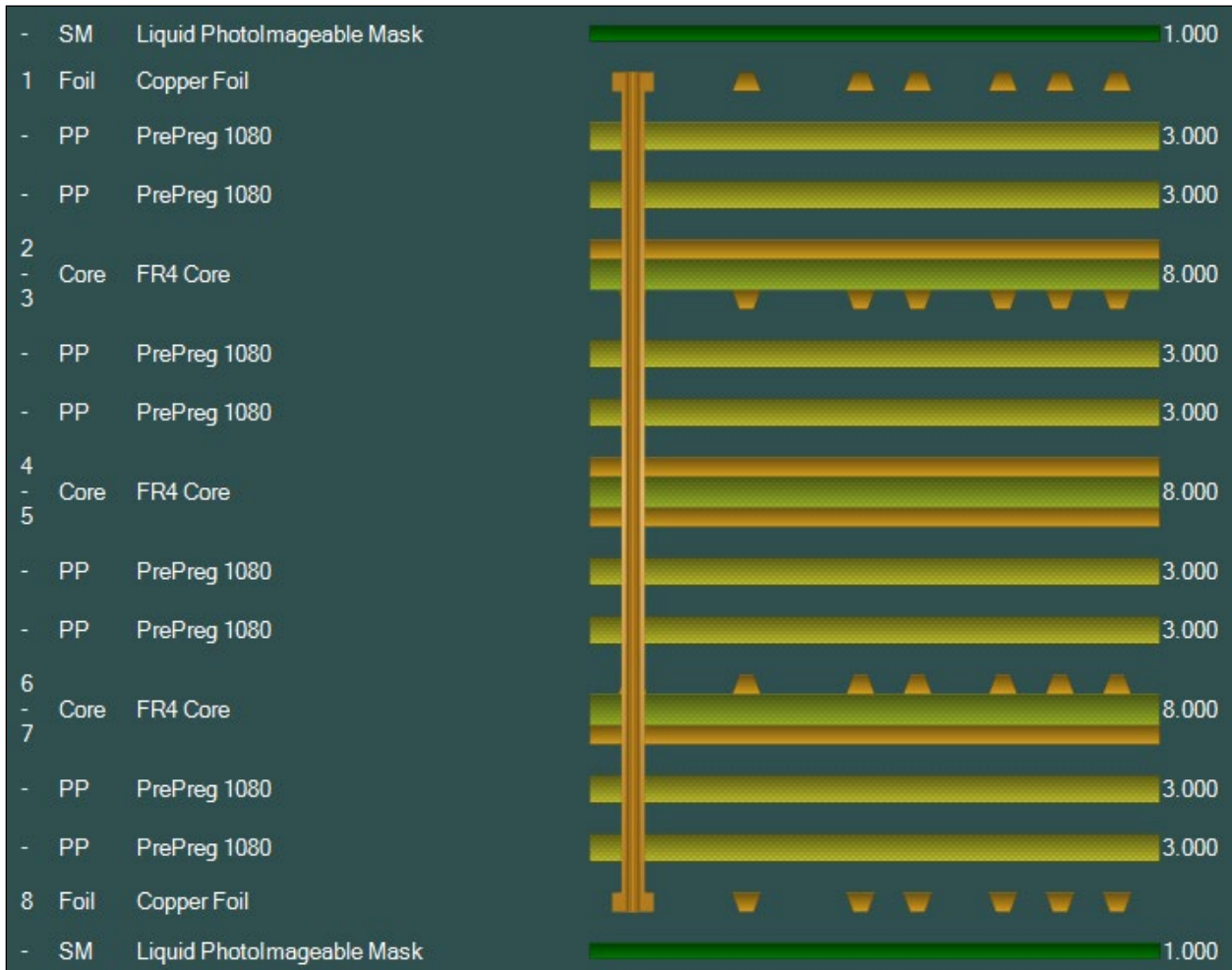

Filtering Materials

When adding or swapping materials, available materials (foils, prepregs, etc.) are listed in the associated material library dialog.

Lists can be filtered for materials matching desired parameters (dielectric thickness, Er, etc.) See *Using Speedstack Materials Libraries*.

Saving stackups

It is strongly recommended that users save work frequently and maintain safe backups of stackups and projects.

Creating stackups manually

Speedstack allows the designer to add or edit stackup layers in any order, from top to bottom, bottom to top or from the centre layer outwards. This example will create a four-layer stackup, starting at the centre core layer and adding layers above and below.

Consistency of units

When defining dimensions for a stackup (for example, layer thicknesses) ensure that all measurements are defined using the same units (mils, mm, etc.) throughout the structure and its libraries.

Note: the libraries supplied for these examples are preloaded with sample data only.

Click the File|New command and choose Empty Stackup – creating a project will clear the stackup screen and notes and information text areas – click OK.

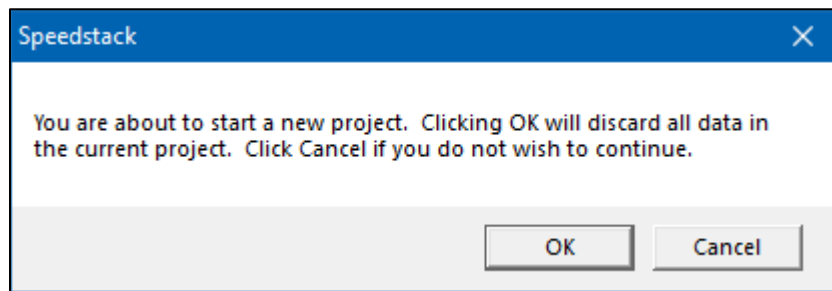

Supply the descriptions in the New Stackup File Properties dialog.

Click the File|Save Stackup or Save Project command to save the stackup or project. Users are recommended to save stackups or projects frequently during the stackup creation process to avoid data loss. Stackup files, project files and library files should be backed up to a secure location.

Editing the stack

When editing the stack, it will probably be most convenient to right click an object in the stack and select the associated command from the context menu. The menu will reflect the commands available for the selected object — commands that are not appropriate for the object are greyed out.

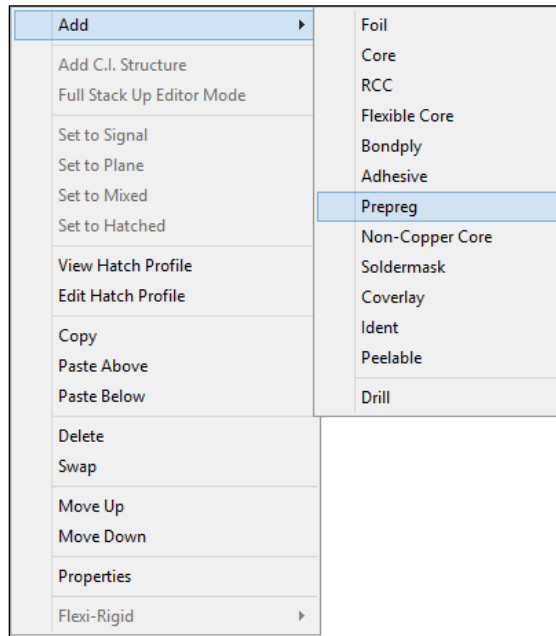

Alternatively, select the object (copper, prepreg, core, etc.) with the left mouse button and choose the command from the Speedstack toolbar.

Adding layers to the stackup

Note, when adding layers to the stackup, the Speedstack alert that adding materials to the stackup can invalidate existing structures

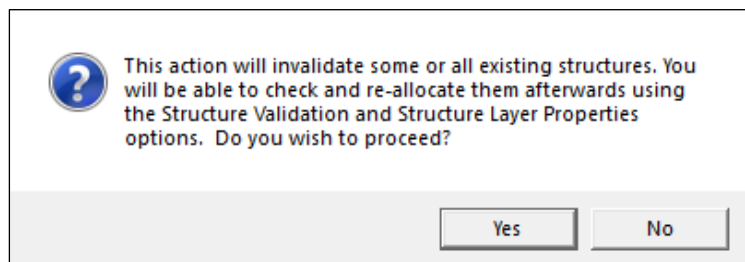

Open Materials Library

Items added to the stackup are added from the currently open materials library. Speedstack opens Program Files\Polar\Speedstack\default.mlbx if it exists; if a different library is required, open it via the Open Materials Library button. The Materials Library toolbar is displayed



Note: Speedstack does not ship with the default.mlbx library.

For this discussion open one of the two sample library files, Speedstack Imperial.mlbx or Speedstack Metric.mlbx.



Open Library

Use the Open Library icon to navigate to the Program Files\Polar\Speedstack\Samples folder, created at installation time.



Open and Append Library

To add the library to the current library, use the Open and Append Library icon

Adding a core layer



Add Layer Material

Click the Add Layer Material button and choose Core...the Core library is displayed

The Core library contains full details of the core material, including base and finished thicknesses, dielectric constant, and upper and lower copper thicknesses.

Supplier Description	Description	Stock Number	Dielectric Base Thickness	Dielectric Finished Thickness	Dielectric Constant	Upper Cu Base Thickness	Lower Cu Base Thickness
CO/001	FR4 Core 2	400-001	2	2	4.2	0.7	0.7
CO/002	FR4 Core 2	400-002	2	2	4.2	1.4	1.4
CO/003	FR4 Core 2	400-003	2	2	4.2	2.8	2.8
CO/004	FR4 Core 3	400-004	3	3	4.2	0.7	0.7
CO/005	FR4 Core 3	400-005	3	3	4.2	1.4	1.4

Click on any of the column buttons to sort the library list by the selected column.



Add Material Above

Choose a core type from the list of cores and click the Add Material Above button. The core is added to the stackup screen. When editing a stack this button adds a core above the selected layer.



Stackup core layer



Add Material below

Layers may also be added below the selected layer. The Add Material below button adds a core below the selected layer.

As each layer is added the stackup information table is updated to reflect the current status of the stackup.

Field	Value
Electrical Layer Count	8
Stack Up Cost	0.00
Copper Thickness	11.0236
Dielectric Thickness	51.9685
Solder Mask Thickness	1.9685
=====	=====
Target Stack Up Thickness	62.9921
Stack Up Thickness	62.9921
Stack Up Thickness with Soldermask	64.9606
=====	=====

Stackup information table

Note: The Stackup Information is printed in red when the stack thickness is outside its tolerance.

With the core selected, the Selected Item table displays the properties of the core.

Selected Item Information : Core

Field	Value
Upper Cu Base Thickness	35.00
Upper Cu Finished Thickness	35.00
Upper Copper Coverage	0
Minimum Trace Width	75.00
Data Filenames	
Dielectric Base Thickness	100.00
Dielectric Finished Thickness	100.00
Dielectric Constant	4.2
Loss Tangent	0.0195
Resin Content	53
Tg	180
Td	0
CAF Resistance	0
Z Axis Expansion	0
Excess Resin	0.00
Isolation Distance	100.00
Lower Cu Base Thickness	35.00
Lower Cu Finished Thickness	35.00
Lower Copper Coverage	0
Minimum Trace Width	75.00

Core layer information

To observe the properties of any material, click the material in the stack and read off the properties in the Selected Item Information panel.

Editing the selected layer properties

To change the properties of the selected object (for example, to modify the dielectric constant or the value for the finished thickness of the dielectric), right click the object in the stackup and choose Properties from the shortcut menu; in this example the Core Properties dialog is displayed.

Note that the Enable Finishing setting in the Tools|Set Stackup Thickness/Enable Finishing dialog must be unchecked to enable the dielectric and copper Finishing Thickness to be specified manually.

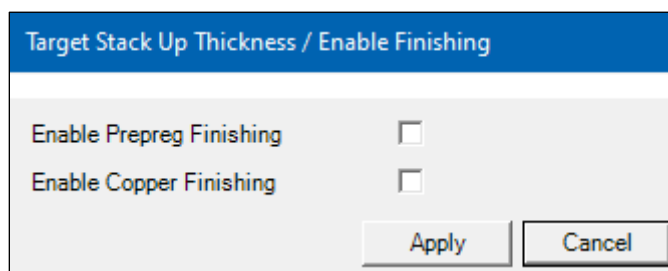

In the dialog below, the Finished Thickness settings are shown greyed out.

Change the value to the corrected value and click Apply.

Core Properties

Main | Notes | Attributes

General Information

Supplier: Polar Samples Exchange Copper:

Supplier Description: CO/008

Description: FR4 Core Cost: 8.00

Stock Number: 400-008 Tolerance: 10.00

Type: FR4 Lead Time: 0.00

Upper Copper

Base Thickness: 35.00 Copper Coverage %: 0.00

Finished Thickness: 35.00 Graphical Colour:

Data Filename:

Trace Inverted: Remove Copper (disabled if structures or sub-stacks exist):

Finishing Applied:

Dielectric

Base Thickness: 100.00 Td: 0.0

Finished Thickness: 100.00 CAF Resistance: 0.0

Dielectric Constant: 4.2000 Z Axis Expansion: 0.0

Loss Tangent: 0.0195 Excess Resin: 0.00

Resin Content %: 53.00 Isolation Distance: 100.00

Tg: 180.0 Graphical Colour:

Lower Copper

Base Thickness: 35.00 Copper Coverage %: 0.00

Finished Thickness: 35.00 Graphical Colour:

Data Filename:

Trace Inverted: Remove Copper (disabled if structures or sub-stacks exist):

Finishing Applied:

Apply

Close

Adding data file names

If available, add the data file name(s) to the upper and lower copper layers and click Apply.

Close the dialog when all changes are completed.

Changes will be reflected in the Stackup Information table.

Changing a layer function

In this example both the signal layers above and below the core dielectric are changed to planes.

Click the lower signal layer and click the Set Layer Plane button. Repeat for the upper signal layer.



Set Layer to Plane

The changes are reflected in the stackup window

1	Core	FR4 Core		
-				8.000
2				

Exchanging layers



Swap Selected Material

To change just the core dielectric (leaving the copper layers unaffected), right click the core material (for example the FR4 in the graphic above) and choose Swap from the context menu or left click the core material and click the Swap Selected Material button. Choose the new core type from the library and click the Swap button. The layer properties will change to reflect the new material and changes appear in the Stackup Information table.

Adding prepreg layers



Add Material

With the core selected, click the Add Material button and choose Prepreg...; the Add Prepreg library is displayed.

Supplier	Supplier Description	Description	Z	Stock Number	Dielectric Base Thickness	Dielectric Finished Thickne	Dielectric Constant	Loss Tangent	Resin Content
Polar Samples	PP/006	PrePreg 106		300-006	50	50	4.2	0.0195	60
Polar Samples	PP/001	PrePreg 1080		300-001	75	75	4.2	0.0195	60
Polar Samples	PP/004	PrePreg 1651		300-004	150	150	4.2	0.0195	47
Polar Samples	PP/002	PrePreg 3080		300-002	75	75	4.2	0.0195	60
Polar Samples	PP/003	PrePreg 3113		300-003	100	100	4.2	0.0195	53
Polar Samples	PP/005	PrePreg 7628		300-005	200	200	4.2	0.0195	45

The Prepreg library contains details of the prepreg material, including base and finished thickness, dielectric constant and loss tangent, resin content and excess resin.



Add Material Above

Choose the Prepreg material from the database and click the Add Material Above button.



The prepreg layer is added above the core.

To change the properties of the prepreg material right-click the layer and choose Properties from the short cut menu. Items with a white background can be modified.

Dielectric			
Base Thickness	<input type="text" value="125.00"/>	Td	<input type="text" value="0.0"/>
Finished Thickness	<input type="text" value="125.00"/>	CAF Resistance	<input type="text" value="0.0"/>
Dielectric Constant	<input type="text" value="4.2000"/>	Z Axis Expansion	<input type="text" value="0.0"/>
Loss Tangent	<input type="text" value="0.0195"/>	Excess Resin	<input type="text" value="0.00"/>
Resin Content %	<input type="text" value="47.00"/>	Isolation Distance	<input type="text" value="125.00"/>
Tg	<input type="text" value="180.0"/>	Graphical Colour	<input type="color" value="#90EE90"/>



Add Prepreg Below

Select the Core material and click Add Material|Prepreg to display the prepreg library and click the Add Below button. The layer of prepreg is added below the core.

-	PP	PrePreg 1080	3.000		3.000
1			2.800		
-	Core	FR4 Core	8.000		8.000
2			2.800		
-	PP	PrePreg 1080	3.000		3.000

Modify the properties as necessary.

Choosing the Display Data fields

The Speedstack Stack Editor provides a range of useful data fields for optional display alongside each material. Base and Finish (Display Field 4) refer to thicknesses and weights and appear to the left of the stackup graphic.

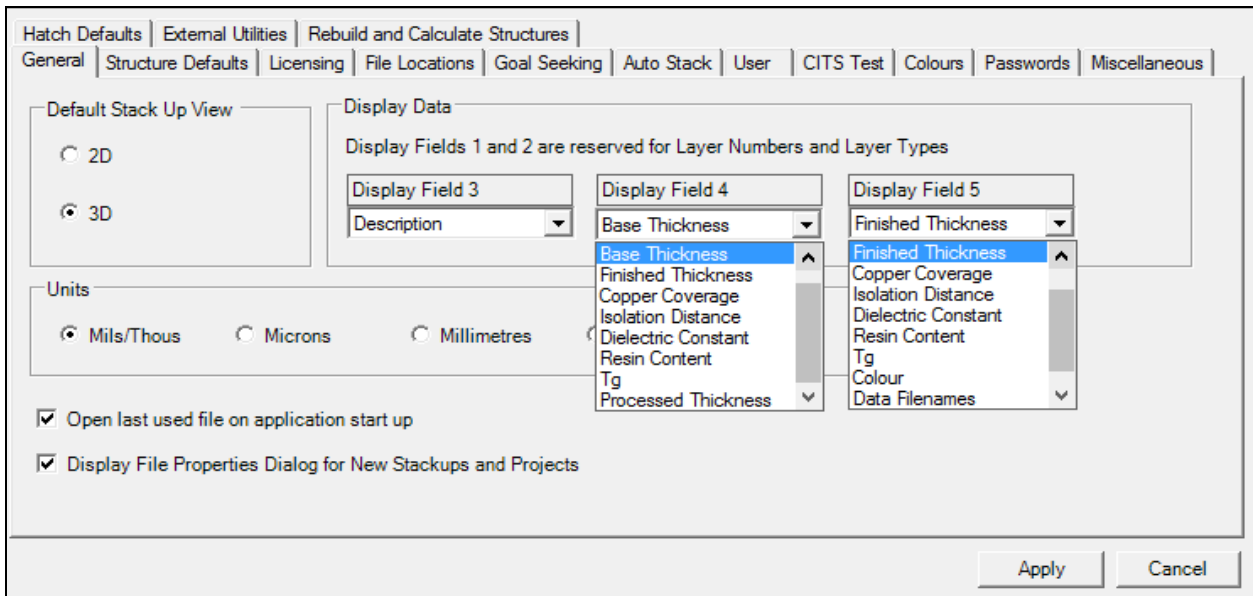

Display Field 5 appears to the right of the stackup graphic. Choose the data of interest from the dropdown lists.











Note: Processed Thickness is the Finished Thickness for copper layers and Isolation Thickness for dielectric layers.

Adding a foil layer

Select the upper layer of prepreg and click the Add Layer Material button and choose Foil to display the copper foil library.

Supplier Description	Description	Stock Number	Cu Base Thickness	Type	Cost	Lead Time
FO/001	Copper Foil	100-001	0.7	Copper	1	0
FO/002	Copper Foil	100-002	1.4	Copper	2	0
FO/003	Copper Foil	100-003	2.8	Copper	3	0

Choose the foil type and click Add Above, the copper foil layer is added above the selected prepreg layer.

1	Foil	Copper Foil	1.400								
-	PP	PrePreg 1080	3.000								3.000
2	Core	FR4 Core	2.800								8.000
-			2.800								
-	PP	PrePreg 1080	3.000								3.000

Repeat the procedure for the lower prepreg layer: select the lower prepreg layer and add a layer of copper foil below the layer (shown below as layer 4 in the 3D view).

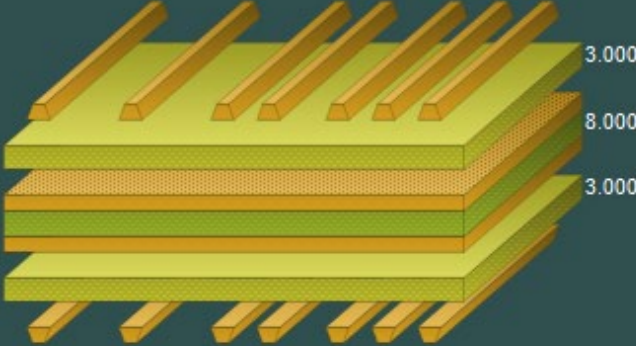
1	Foil	Copper Foil	1.400		3.000
-	PP	PrePreg 1080	3.000		8.000
2	Core	FR4 Core	2.800		3.000
-			2.800		
-	PP	PrePreg 1080	3.000		
4	Foil	Copper Foil	1.400		

To alter the foil properties, right-click the foil layer and choose Properties. Using the Properties dialog the user can, for example, specify that the trace is shown inverted.

Copper

Base Thickness	<input type="text" value="17.78"/>	Copper Coverage %	<input type="text" value="0.00"/>
Finished Thickness	<input type="text" value="35.56"/>	Graphical Colour	
Data Filename	<input type="text"/>		
Trace Inverted	<input checked="" type="checkbox"/>	Remove Copper (disabled if structures or sub-stacks exist)	<input type="checkbox"/>
Finishing Applied	<input checked="" type="checkbox"/>		

Note that the stackup is being built symmetrically about the centre layer.

Adding solder mask layers

With the upper layer of foil selected, click the Add Layer Material button and choose Soldermask to add a layer of LPI solder mask above the foil.

Supplier Description	Description	Stock Number	Mask Thickness	Dielectric Constant	Colour	Type	Cost
SM001	Liquid PhotoImageable Mask	500-001	1	4	Green	SolderMask	0.5
SM002	Liquid PhotoImageable Mask	500-002	1	4	Green	SolderMask	0.6
SM003	Liquid PhotoImageable Mask	500-003	1	4	Blue	SolderMask	0.6
SM004	Liquid PhotoImageable Mask	500-004	1	4	Red	SolderMask	1

Repeat the process for the solder mask material below the lower foil layer.

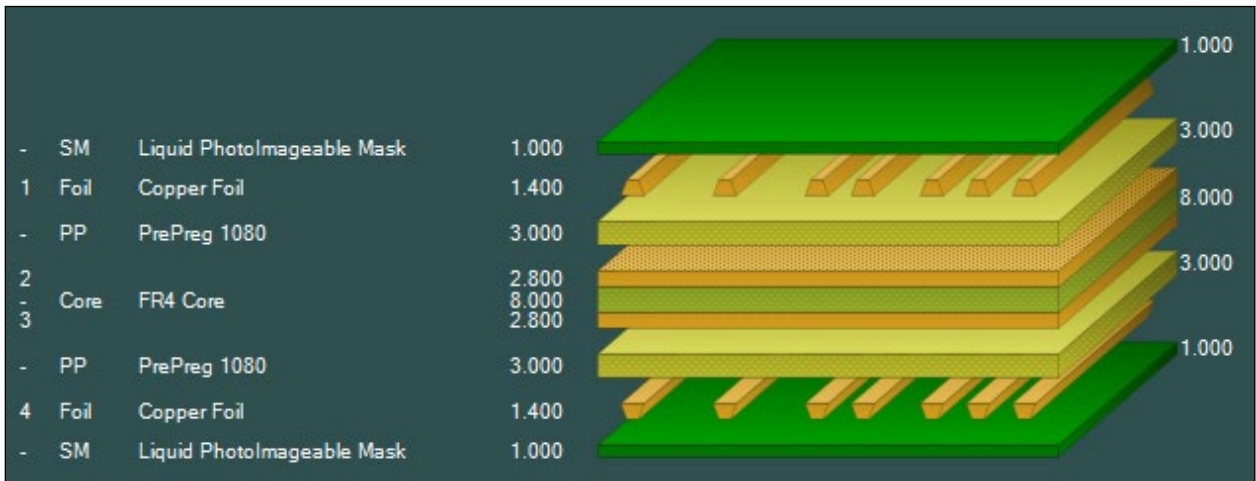

Adding the Ident layers

Select the lower LPI Soldermask layer and click the Add Layer Material button and choose Ident to add a layer of Screened Ident below the layer. The sample Ident library includes ink thickness and colour

Supplier Description	Description	Stock Number	Ink Thickness	Colour	Type	Cost
ID/001	Screened Ident	600-001	2	White	Ident	0.1
ID/002	Screened Ident	600-002	2	Yellow	Ident	0.1
ID/003	Screened Ident	600-003	2	Black	Ident	0.1

Repeat for the upper layer.

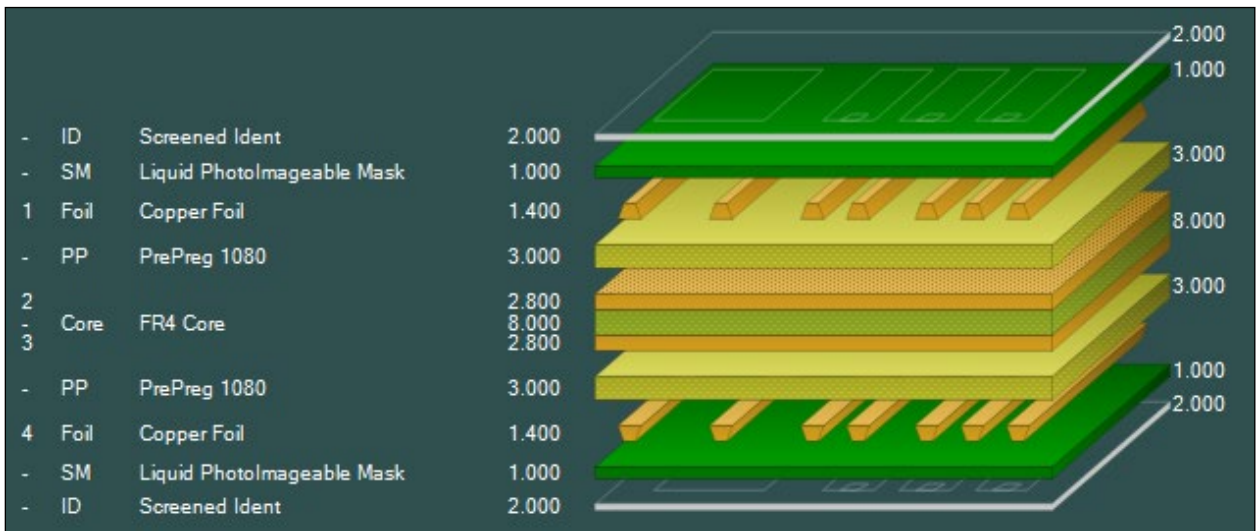

Adding notes

Click the Notes tab and click Add to supply descriptive and explanatory notes.

Deleting a layer

To remove a layer from the stackup select the layer and click the Delete button.



Delete Selected Material

Copying a layer

With layers defined it will often be found more convenient to copy an existing layer and paste it into the stackup than to create a new layer “from scratch”.

Select the layer to be copied and click the Copy Selected Material button.

Click the layer nearest the destination location and choose Paste Above or Paste Below as appropriate

Note: when modifying the stackup it may be necessary to redefine the drill information to reflect the changes.

Copying material properties

Speedstack can copy material properties from one material in the stackup and paste them onto multiple materials simultaneously.

For example, to replace the three prepreg materials below Layer 3 in the stackup below with the Layer 1 material, PrePreg 1080, select the source material (shown highlighted below) and click Copy Material Properties



Copy Material Properties

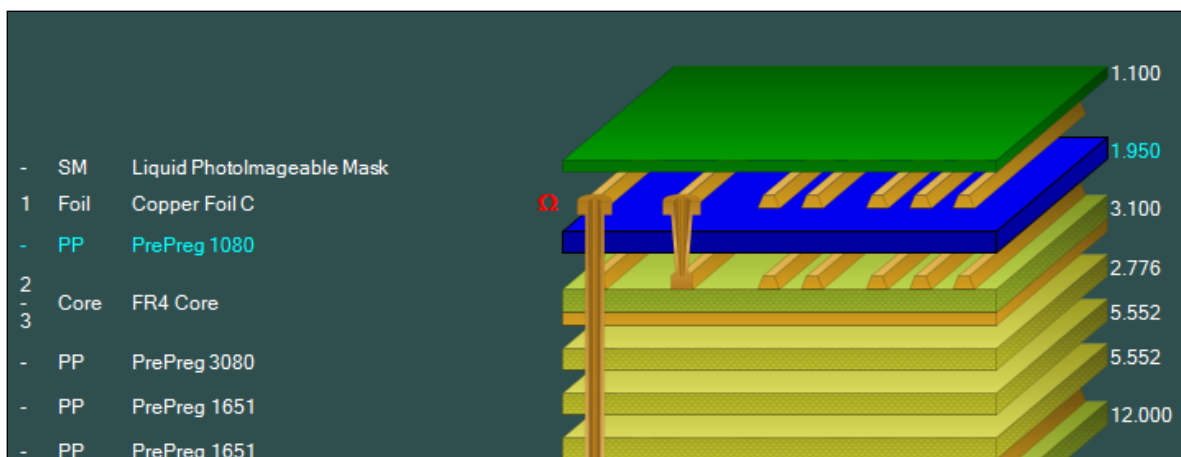

Select the three target layers

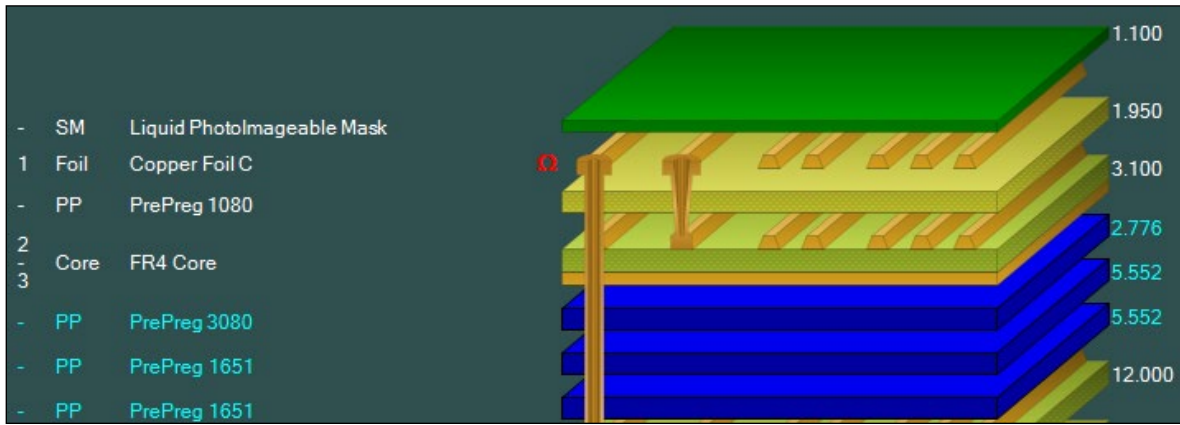

Paste Material Properties

Click Paste Material Properties – the Paste Material Properties dialog is displayed.

Paste Material Properties

Please select the Property Groups that you wish to paste to the selected materials:

General Properties (All Materials)

- General Information (Supplier, Description, Stock Number etc)
- Notes (5 x Note properties)
- Colour (Draw colour)

Conductor Properties (Foil, Core, RCC, Flex Core)

- Copper (Base and Finished Thickness, Copper Coverage etc See Note 1)

Note 1: Layer Numbers and Layer Types assigned to Copper layers are not copied.

Dielectric Properties (Core, RCC, Prepreg, Flex Core, Bondply, Adhesive)

- Dielectric (Base and Finished Thickness, Isolation Distance, Dielectric Constant etc)

Solder Mask Properties (Solder Mask)

- Solder Mask (Thickness, Dielectric Constant etc)

Coverlay Properties (Coverlay)

- Coverlay (Base and Finished Thickness, Dielectric Constant etc)

Ident Properties (Ident)

- Ident (Thickness etc)

Peelable Properties (Peelable)

- Peelable (Thickness etc)

Select / Deselect All

Apply Cancel

Select the property groups that are to be applied to the target materials and click Apply. Properties that do not apply for a material type are ignored.

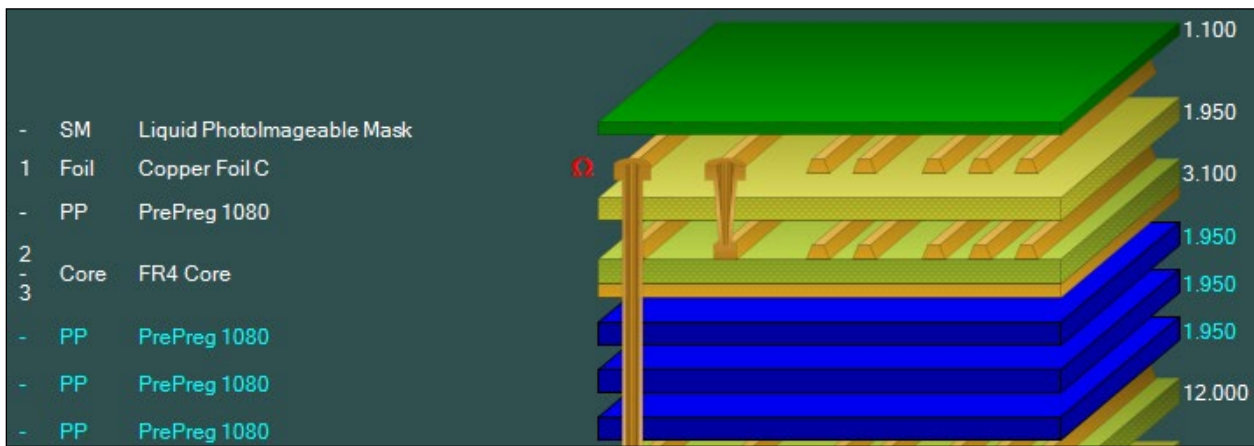

In this example all material properties have been applied to the three target materials.

Note: When changing multiple materials simultaneously it is important to review the resulting stackup.

It will probably be necessary to recalculate any associated controlled impedance structures, especially if dielectric height and copper thickness parameters have changed.

Moving materials



Move Selected
Material Up



Move Selected
Material Down

To move materials within the stackup click Move Selected Material Up and Move Selected Material Down.

When a material is moved it is exchanged with the layer above or below, respectively.

Applying finishing

To apply the finished thickness factor throughout the board, click the Apply Finishing button with no material selected.

To reset the finished thickness back to the original base thickness of the materials throughout the board, click the Reset Finishing button with no material selected.



Apply Finishing



Reset Finishing

Note: when applying or resetting finishing, if a material is selected it will be necessary to specify whether finishing is to be applied to the selected material only or the whole stack.

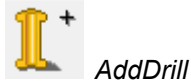

AddDrill

Adding drills

To add a drill between layers, click the Add Drill button; the Add Drill dialog is displayed.

Drill information is stored in columns. Select the column in which to place the drill. Choose the first and second electrical layer numbers (layers 1 and 4 in the example).

Specify the drill type, mechanical or laser and whether through plated and whether the layers are capped.

Note that with laser drills the order of drill layers is important, e.g. layer 1 and 4 is different from layer 4 and 1.

Specifying the drill fill type

Choose the Fill Type from the dropdown list of fills.

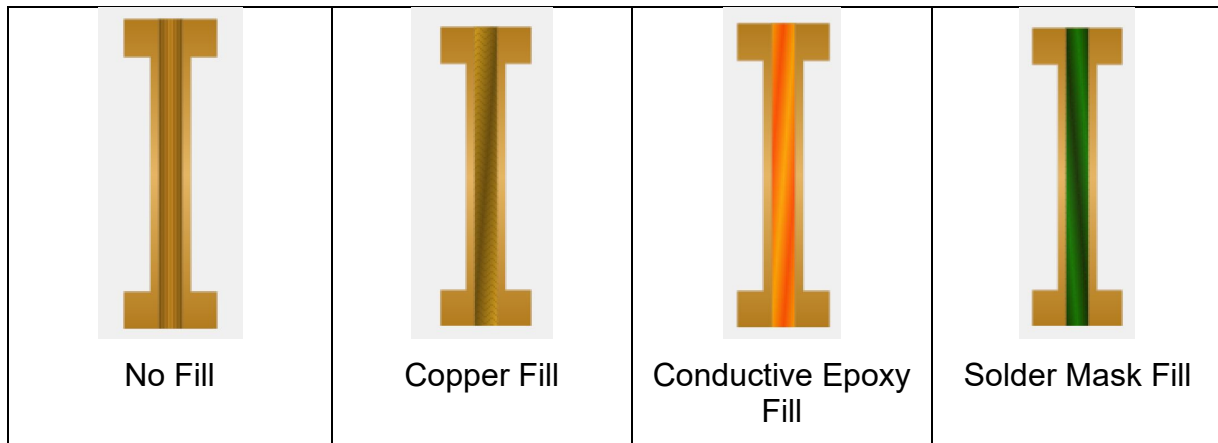

Adding the drill data filenames

Optionally, add the NC drill data filenames.

Optionally, add the hole count, number of different hole sizes and the minimum hole size. Click Add and close the dialog. The drill information is added to the stackup. The example below contains through plated and laser drill information.

Note: The drill properties (i.e. Drill Information and Hole Information) are retained between each Add Drill operation. This can speed up the process of adding drills, especially when multiple drills of the same type are being added to the stackup.

The finished stackup is shown below

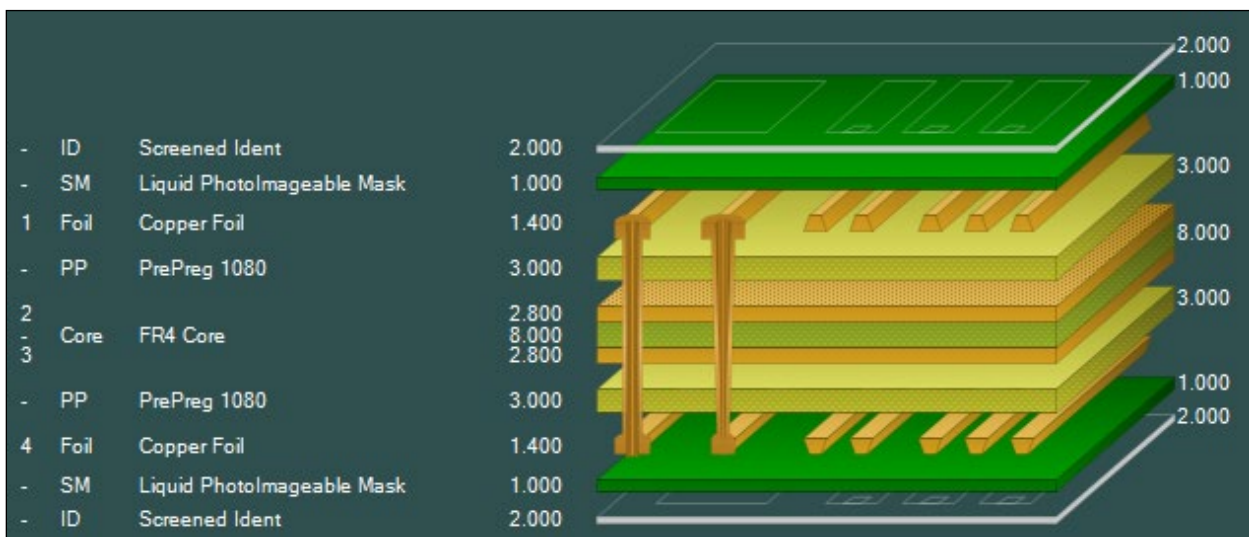

Drill capping

The Drill Cap feature documents when via holes are capped, i.e., where a conductive 'cap' is added to the via hole during fabrication. Capping is often applied to buried vias, (plated holes that start and end on inner layers of a stack up.)

Mechanical drills Drill Cap option

Drill Information

Mechanical Fill Type
 Laser
 Laser (Stacked)
 Back Drill
 Through Plated First Layer Capped
 Second Layer Capped

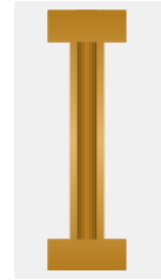

Mechanical drills offer four drill cap states: (the default state is no drill cap when adding a drill.)

- Neither first or second layer capped
- First layer capped
- Second layer capped
- Both layers capped

Laser drills Drill Cap option

Drill Information

Mechanical Fill Type
 Laser
 Laser (Stacked)
 Back Drill
 Through Plated First Layer Capped
 Second Layer Capped

Laser drills offer two states (as with mechanical drills the default state is no drill cap when adding a drill.)

- Not capped
- First layer capped

Note that the Second Layer Capped checkbox is disabled.

Specify the Drill Cap option and click Apply – the capping specified is reflected in the Drill Information pane.

Selected Item Information : Drill	
Field	Value
First Electrical Layer No	4
Second Electrical Layer No	7
Mechanical Drill	True
Laser Drill	False
Back Drill	False
Through Plated	True
First Layer Capped	True
Second Layer Capped	True
Fill Type	No Fill
Data Filenames	

Deleting drills

To delete a drill right click the drill and from the context menu choose Delete. To delete all drills choose Delete all Drills – confirm via the dialog below.

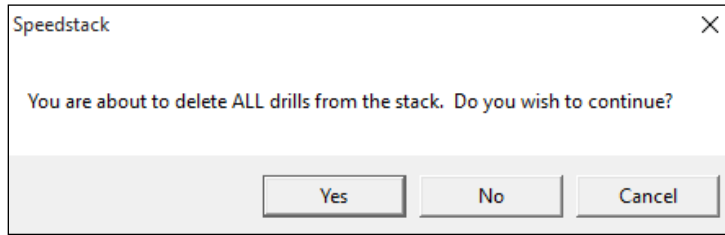

All drills will be cleared from the stack.

Adding stack vias

Speedstack can add stack vias to the stackup in a single operation. To add stack vias between layers 1 and 5 in the stackup below, select layer 1 and click Add Drill.

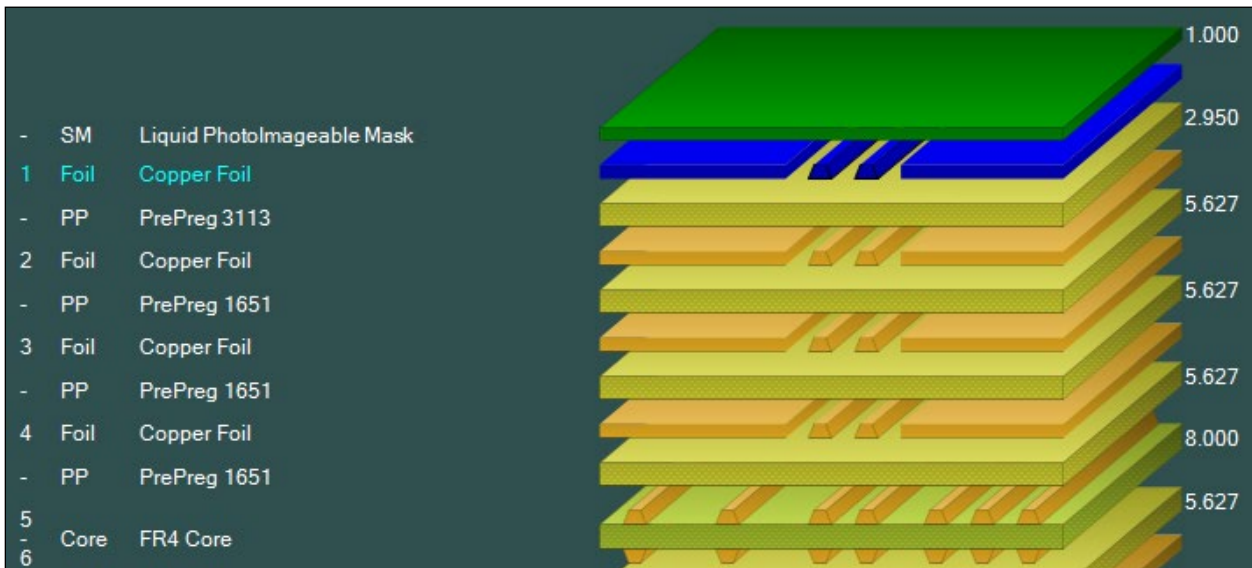

Specify the column number – (Column 1)

Specify electrical layers 1 and 5 (*Note: drills cannot have the first electrical layer on the underside of a core material*)

Choose Laser (Stacked)

From the Fill Type drop down list choose Copper.

Click Add.

The stack vias are added to the stack (below.)

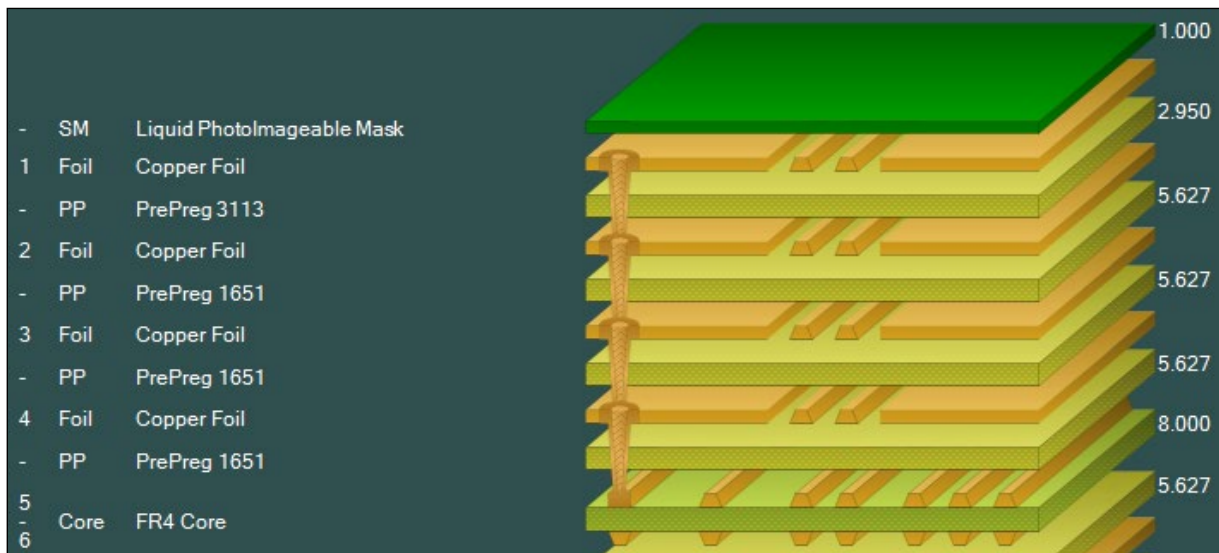

Via stub removal (controlled depth drilling / back drilling)

PCB vias provide a conductive path to allow the transition of electrical signals between circuit layers through the walls of plated holes.

The most common method of connecting two signal layers is to create a plated through hole through the entire board and then remove the unwanted portion of the plated through hole – the *stub*, the unused portion of via extending further than the last connected inner layer – by back drilling.

Stubs can lead to reflections, discontinuity errors that become critical with increasing propagation speed, so are commonly removed.

The stackup below shows a plated through hole back drilled from layer 8 to 6, resulting in a via between layers 1 and 6.

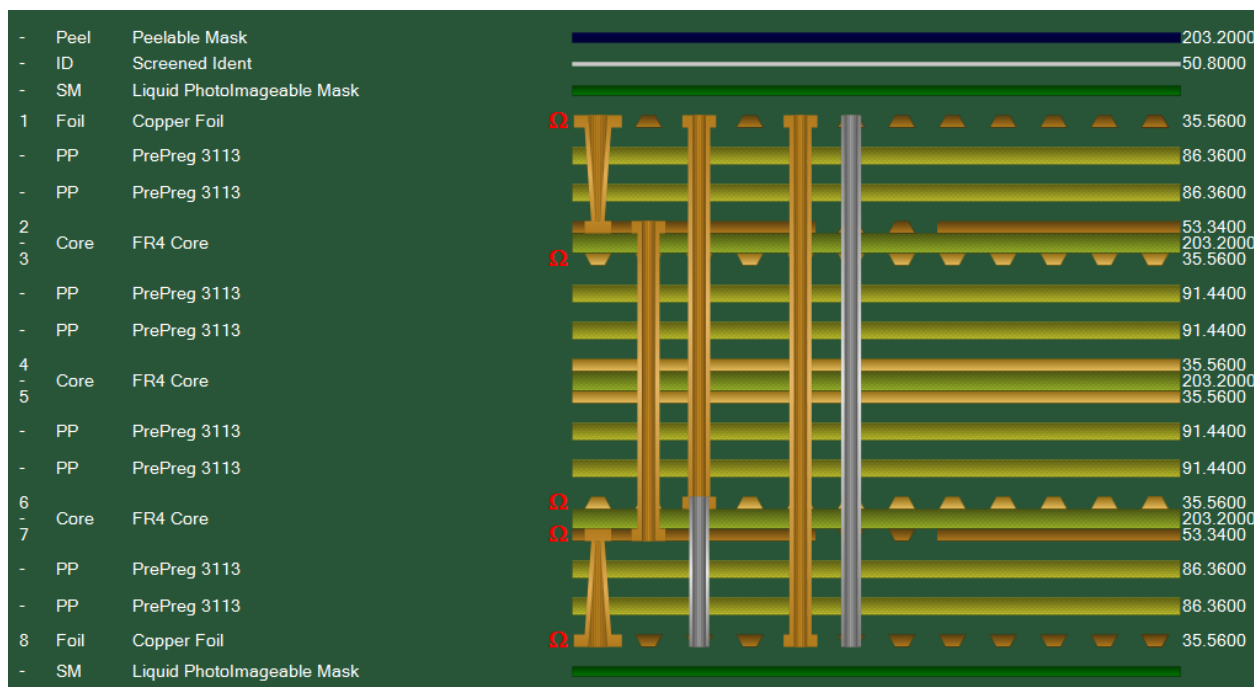

Specifying back drills



Add Drill

To add a back drill click Add Drill to display the Add Drill dialog.

Add Drill
✕

Main
Notes

Electrical Layers

Stack Up Column	First Electrical Layer No (Start Layer)	Second Electrical Layer No (End Layer)	Back Drill Must-Cut Layer No	Back Drill Must-Not-Cut Layer No
<input type="text" value="3"/>	<input type="text" value="8"/>	<input type="text" value="1"/>	<input type="text" value="6"/>	<input type="text" value="5"/>

Drill Information

Mechanical
 Laser
 Laser (Stacked)
 Back Drill

Through Plated
 First Layer Capped
 Second Layer Capped

Data Filenames

Hole Information

Hole Count	Minimum Drill Size
<input type="text" value="0"/>	<input type="text" value="0.00"/>
Different Hole Sizes	Minimum Drill Size Tolerance (Abs)
<input type="text" value="0"/>	<input type="text" value="0.00"/>
Minimum Hole Size	Minimum Barrel Wall Thickness
<input type="text" value="0.00"/>	<input type="text" value="0.00"/>
Minimum Pad Size	
<input type="text" value="0.00"/>	

Back Drill Information

Minimum Distance From Must-Cut Layer	Minimum Distance From Must-Not-Cut Layer
<input type="text" value="0.00"/>	<input type="text" value="0.00"/>
Maximum Distance From Must-Cut Layer	Maximum Distance From Must-Not-Cut Layer
<input type="text" value="0.00"/>	<input type="text" value="0.00"/>
Primary Drill Size	Back Drill Type
<input type="text" value="0.00"/>	<input type="text" value="Pointed"/>

To specify the controlled drilling depth, from the Add Drill dialog:

Choose Back Drill from the Drill Information pane

Choose the drill column and specify the start layer.

Choose the layer number from the Back Drill Must Cut Layer No.

Choose the layer number from Back drill Must Not Cut Layer No.

Electrical Layers				
Stack Up Column	First Electrical Layer No (Start Layer)	Second Electrical Layer No (End Layer)	Back Drill Must Cut Layer No	Back Drill Must Not Cut Layer No
7	8	1	3	2

Specifying back drill information

Many drill machines are capable of modifying drill depth to accommodate inner layer thickness variations.

The Back Drill Information fields allow designers and suitably equipped board shops to specify controlled stub lengths.

Back Drill Information	
Minimum Distance From Must-Cut Layer	Minimum Distance From Must-Not-Cut Layer
0.00	0.00
Maximum Distance From Must-Cut Layer	Maximum Distance From Must-Not-Cut Layer
0.00	0.00

Use the Back Drill Information fields to specify the Minimum and Maximum Distances from Must-Cut Layer and Minimum and Maximum Distances from Must-Not-Cut Layer.

Choosing a back drill type

Back drill types can be pointed, flat or router as shown below.

From Back Drill Information, specify the back drill type from the Back Drill Type dropdown

Back Drill Type
Router
Pointed
Flat
Router

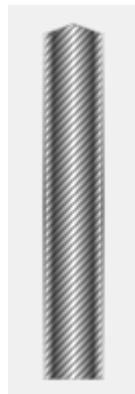

Pointed

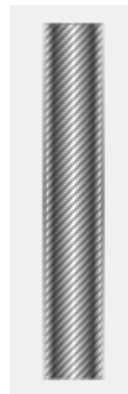

Flat

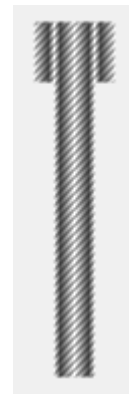

Router

Choosing back drill capping

Capping may be applied to the first layer of each back drill type.

Note that the Second Layer Capped checkbox is disabled.

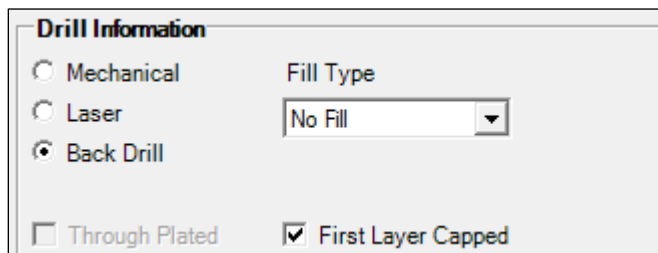

From the Drill Information pane choose Back Drill and click on First Layer Capped

From Back Drill Information specify the back drill type

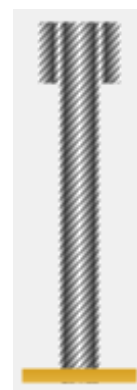
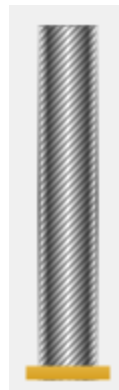
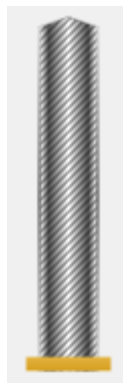

Capping is applied as shown.

The stackup below includes a router type back drill with capping applied

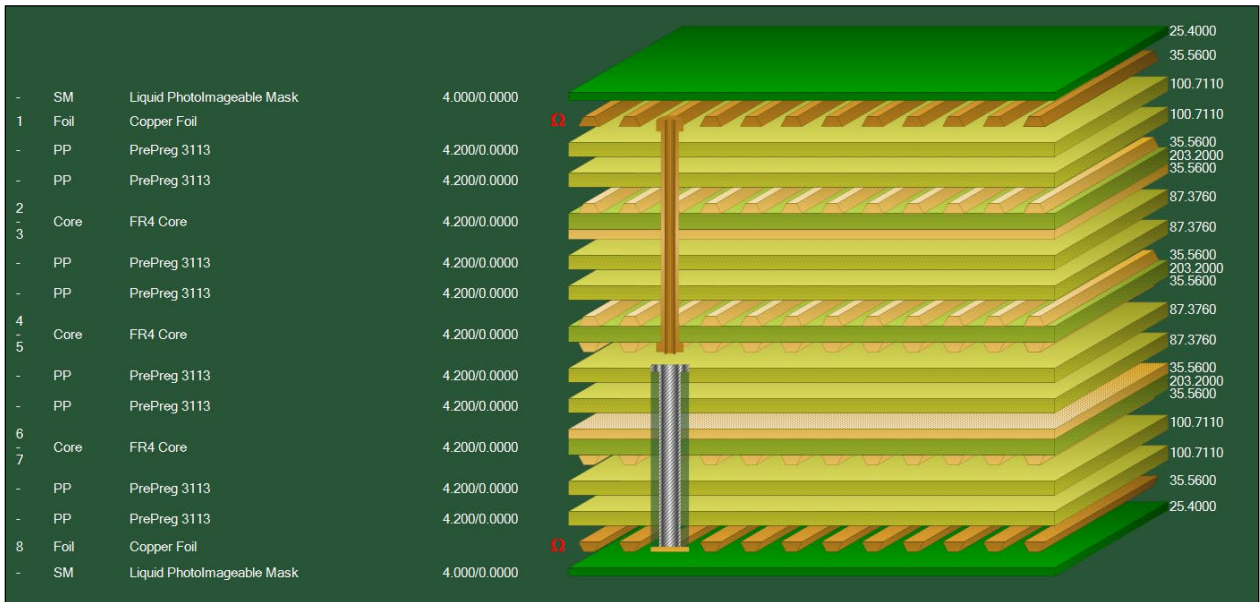

The drill information is reflected in the Technical Report
 From the File menu choose Print Technical Report
 The Stack Data Table includes the drill and back drill information

Layer	Stack up	Description	Copper Layer Type	Base Thickness	Processed Thickness	Resin Content	εr
		Liquid Photolimageable Mask			25.400		4.000
1		Copper Foil	Signal	17.780	35.560		
		PrePreg 3113		101.600	100.711	53.000	4.200
		PrePreg 3113		101.600	100.711	53.000	4.200
2		FR4 Core	Signal	35.560	35.560		4.200
		PrePreg 3113	Plane	203.200	203.200	45.000	4.200
		PrePreg 3113		35.560	35.560		
		PrePreg 3113		101.600	87.376	53.000	4.200
		PrePreg 3113		101.600	87.376	53.000	4.200
4		FR4 Core	Signal	35.560	35.560		4.200
		PrePreg 3113	Signal	203.200	203.200	45.000	4.200
		PrePreg 3113	Signal	35.560	35.560		
		PrePreg 3113		101.600	87.376	53.000	4.200
		PrePreg 3113		101.600	87.376	53.000	4.200
6		FR4 Core	Plane	35.560	35.560		4.200
		PrePreg 3113	Signal	203.200	203.200	45.000	4.200
		PrePreg 3113	Signal	35.560	35.560		
		PrePreg 3113		101.600	100.711	53.000	4.200
		PrePreg 3113		101.600	100.711	53.000	4.200
8		Copper Foil	Signal	17.780	35.560		
		Liquid Photolimageable Mask			25.400		4.000

Copper Thickness = 284.480 | Dielectric Thickness = 1361.948 | Solder Mask Thickness = 50.800 |
 Stack Up Thickness = 1646.428 | Stack Up Thickness with Soldermask = 1697.228
 Stack Up Cost = 77.00
 Simple Percentage Finishing Class: 'Class 1' = 17.780

Page 2 of the Technical Report displays the Drill Data Table

Drill Image	1st Layer	2nd Layer	Column Position	Drill Type	Must-Cut Layer No	Must-Not-Cut Layer No
	1	5	3	Mechanical PTH	-	-
	8	-	3	Back Drill	6	5

Displaying the stackup in 2-dimensional view



See 2D View

To change the view of the stackup from its default 3-dimensional aspect, click the See 2D View button. The stackup is displayed in 2-dimensional view.

-	ID	Screened Ident	2.000		2.000
-	SM	Liquid PhotoImageable Mask	1.000		1.000
1	Foil	Copper Foil	1.400		
-	PP	PrePreg 1080	3.000		3.000
2	Core	FR4 Core	2.800		8.000
3			2.800		8.000
-	PP	PrePreg 1080	3.000		3.000
4	Foil	Copper Foil	1.400		
-	SM	Liquid PhotoImageable Mask	1.000		1.000
-	ID	Screened Ident	2.000		2.000



See 3D View

Click the View 3D button to restore the 3 dimensional view.

Mirror Builds

Mirror Build allows the designer to consider the stack in two halves, designing and building, for example, just the top half and mirroring the structure into the lower half.

Build the top half of the stack, including any controlled impedance structures and click the Mirror Build button; specify whether the current set of layers is the upper or lower half of the stack. To maintain symmetry, Speedstack will add a layer of material as appropriate to the stack;

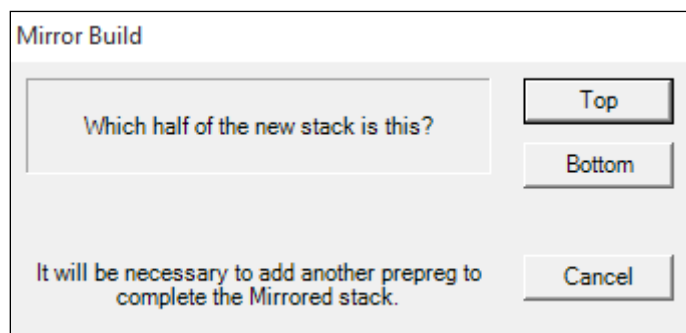

the stack is reflected symmetrically into the lower half.

Symmetrical Builds

In Symmetrical Build mode the Speedstack maintains stack symmetry as the stack designer creates or edits a stack. Changes in one half of the stack are reflected in the opposite half of the stack to ensure a symmetrical stack.

This example considers an 8-layer stack – beginning with three cores and then using Symmetrical Build.

Creating a new stack

Create a new empty stackup and add three cores.

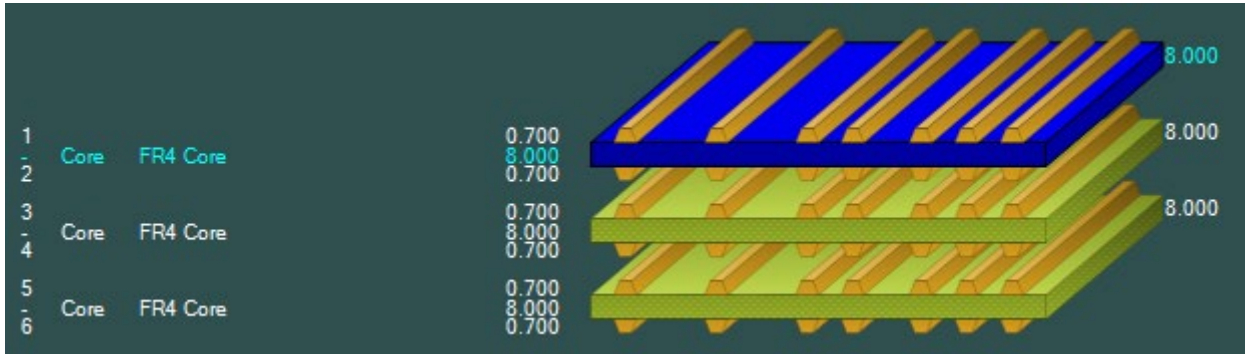

When constructing complex structures, it will often be found easier to use the two-dimensional aspect.



View 2D button

To change the view of the stackup from its default 3-dimensional aspect, click the See 2D View button. The stackup is displayed in 2-dimensional aspect.

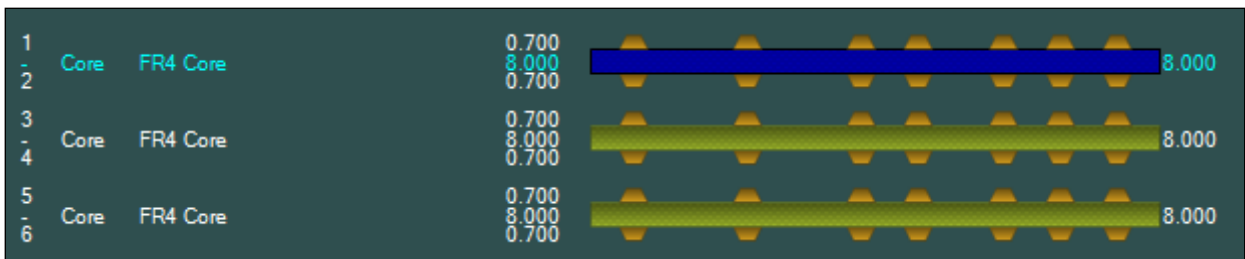

Adding a prepreg layer in Symmetrical Mode

In this example it is necessary to add prepreg layers between cores to achieve the required dimensions.



Symmetrical OFF



Symmetrical ON

Switch to Symmetrical Mode and work in the top half of the stack – in Symmetrical Mode as layers are added to the top half of the stackup Speedstack will add layers to the lower half of the stackup to maintain stack symmetry.

To add a layer of prepreg between Layers 2 and 3 select Layer 3 (the selected layer is shown highlighted in the figure below.)

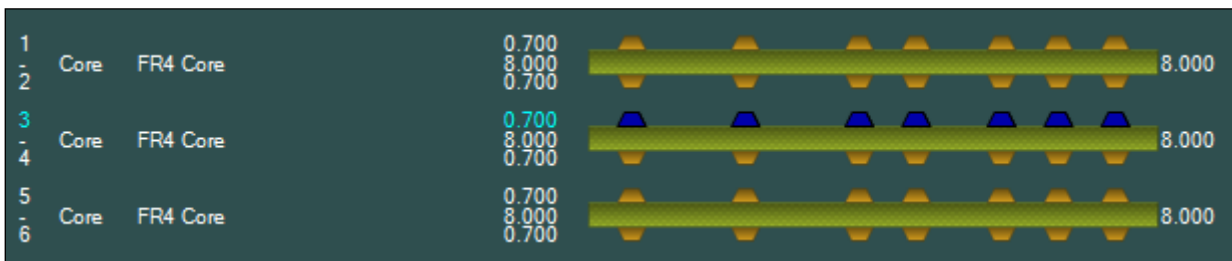

Click the Add Material button and add a layer of prepreg above Layer 3 (shown highlighted in the figure below).

In Speedstack's symmetrical mode the prepreg layer is automatically reflected in the lower half of the structure.

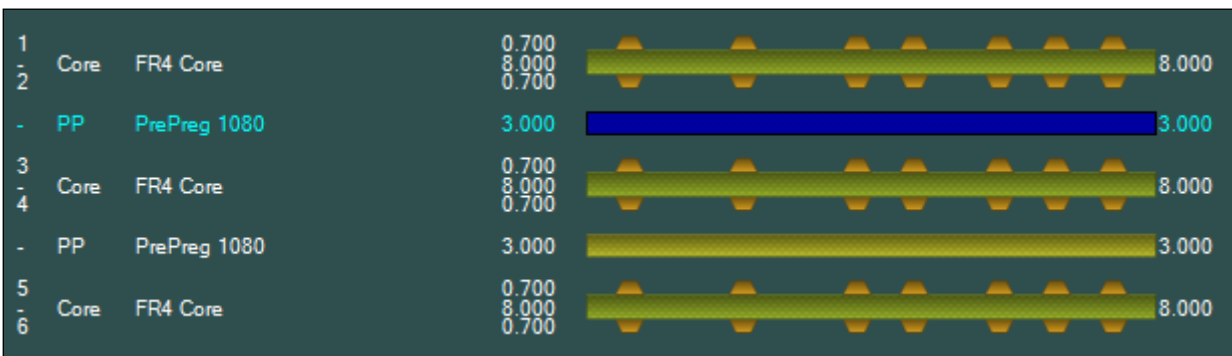

Adding a second prepreg layer

Now add a second layer of PrePreg 1080 above the layer just added; the new prepreg layer is reflected in the lower half of the stack as shown below.

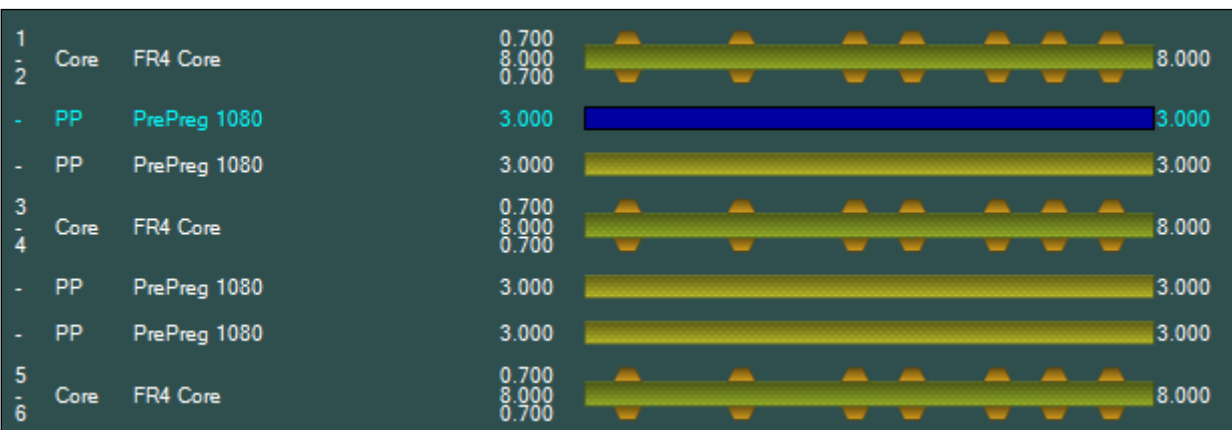

Next, add a layer of prepreg above layer L1 in the upper half of the stackup.

Speedstack in symmetrical mode automatically maintains stack balance by adding the corresponding layer below L6.

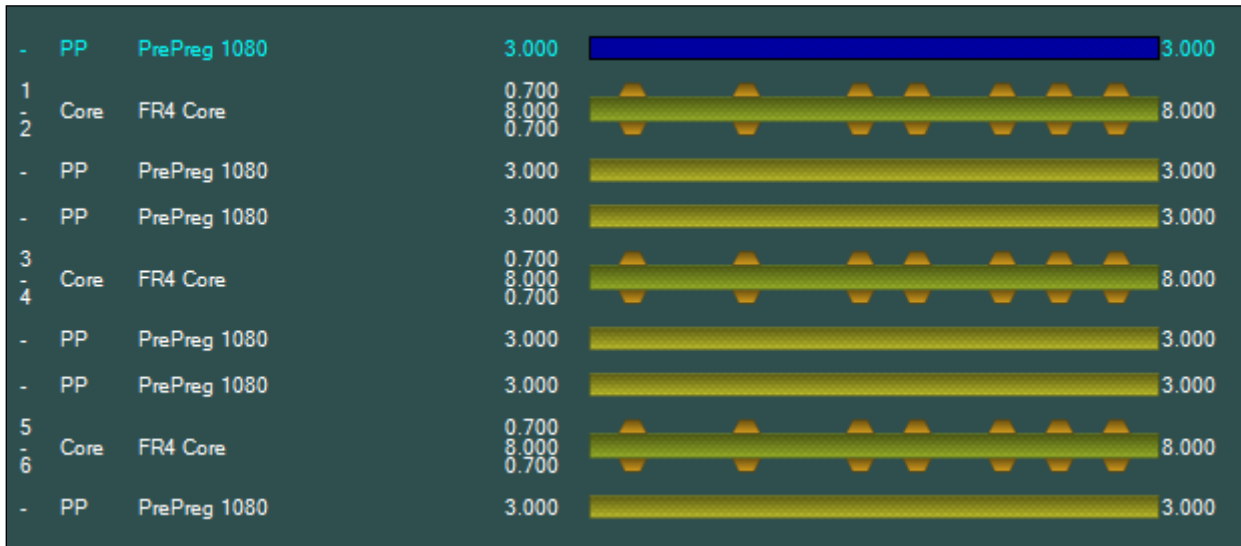

Adding foil, LPI Mask and Ident layers

Next, add a foil layer (L1 below) which is mirrored as L8; as part of the process Speedstack inverts layer L8.

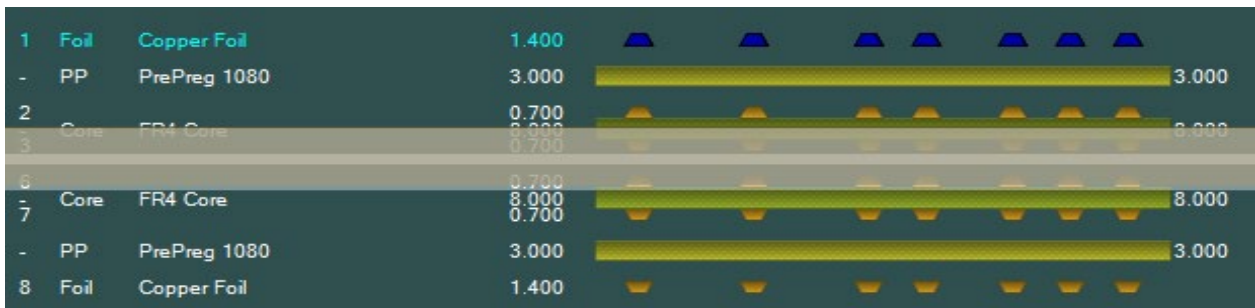

Next, LPI solder mask is applied to the top side of the stackup and reflected on the bottom side.

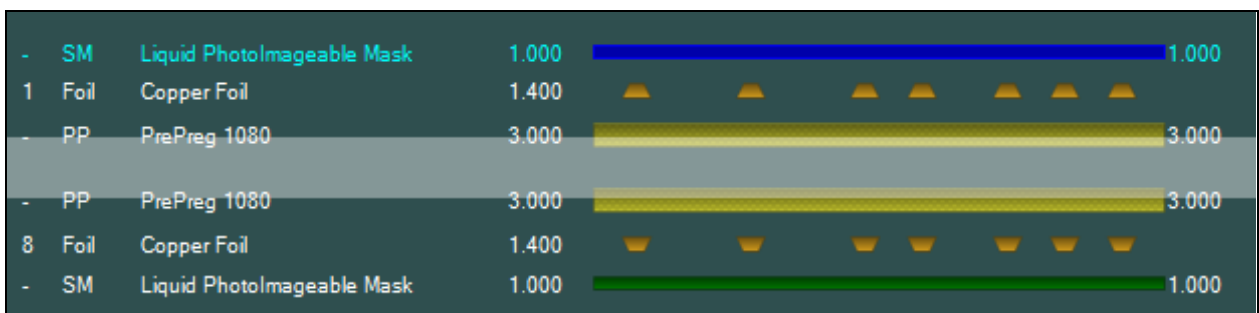

Ident layers (which are not considered components of electrical symmetry) will not be automatically reflected by Speedstack as they are added and must be applied separately to each side of the board.

Select the upper solder mask and add an Ident material above; select the lower solder mask and add an Ident material below.

-	ID	Screened Ident	2.000		2.000
-	SM	Liquid PhotoImageable Mask	1.000		1.000
1	Foil	Copper Foil	1.400		
8	Foil	Copper Foil	1.400		
-	SM	Liquid PhotoImageable Mask	1.000		1.000
-	ID	Screened Ident	2.000		2.000

Assigning ground planes



Set Layer To Plane

With all the material in place, assign ground planes; begin with layer L2 – it's reflected in layer L7. Right click the copper (L2) in the top core and choose Set Layer to Plane.

2			0.700		
-	3	Core	FR4 Core	8.000	
	3		0.700		8.000
-	PP	PrePreg 1080	3.000		3.000
-	PP	PrePreg 1080	3.000		3.000
4	Core	FR4 Core	0.700		
-	5		8.000		8.000
	5		0.700		
-	PP	PrePreg 1080	3.000		3.000
-	PP	PrePreg 1080	3.000		3.000
6	Core	FR4 Core	0.700		
-	7		8.000		8.000
	7		0.700		

Repeat the process for the other ground plane layers; layer L4 is designated a ground plane, the change is reflected in L5 in the lower half of the stack.

-	PP	PrePreg 1080	3.000		3.000
4	Core	FR4 Core	0.700		
-	5		8.000		8.000
	5		0.700		
-	PP	PrePreg 1080	3.000		3.000

The completed stack is shown below

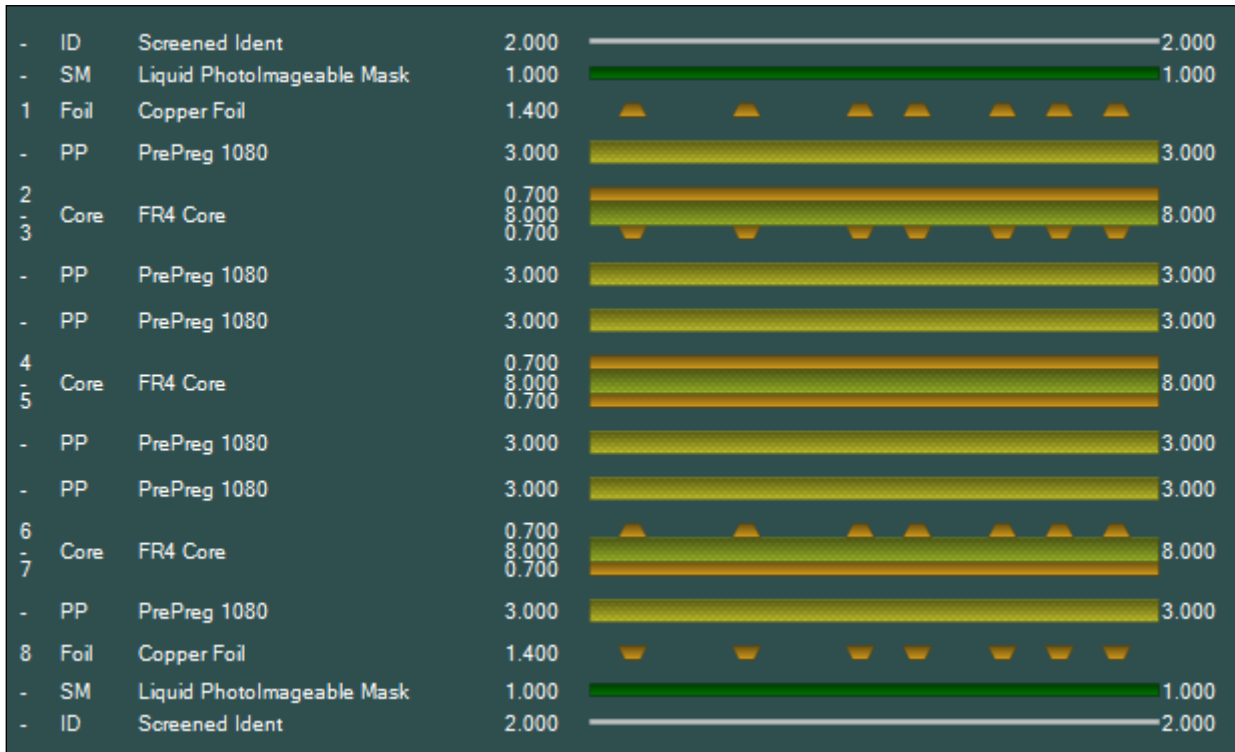

Using Ormet® Z-axis Interconnect

Speedstack provides support for Ormet® Z-Axis Interconnect – or other Any Layer Interstitial Via Technology. Z-Axis Interconnect provides a method of connecting two PCB boards using a conductive paste filled into the vias of a drilled prepreg.

In Speedstack, Z-Axis Interconnects may be incorporated into a stackup to connect two cores or foils together.

Ensure the Tools|Options|Miscellaneous|Drill Validation Check box is unticked

Drill Validation Check

This option prevents invalid drills from being added to the stack up. For instance, a drill that starts from the lower copper side of core materials. Uncheck this option if you use a drilling technology that permits drills to be placed between electrical layers which are not typically supported by conventional mechanical and laser drills

With this validation check disabled, Ormet® Z-Axis Interconnects can be placed between electrical layers which are not typically supported by conventional mechanical and laser drills. The Speedstack graphic below shows interconnects (highlighted in red) bonding adjacent cores.

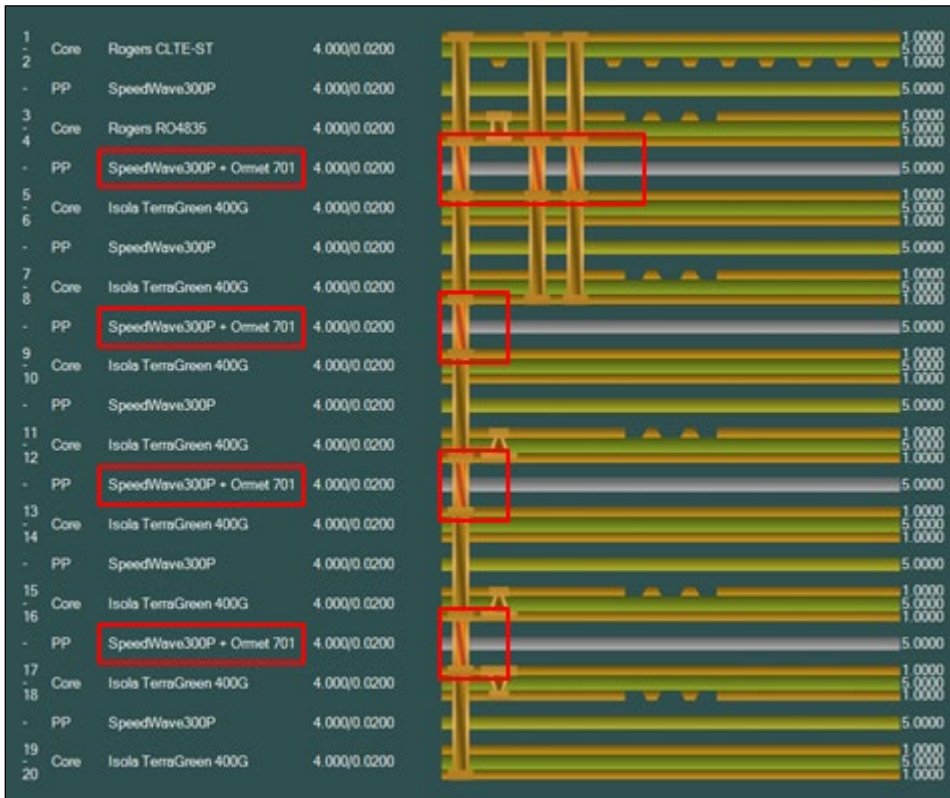

Adding Ormet® Z-Axis Interconnects

Adding a Z-Axis Interconnect to a Speedstack stackup consists of adding the specified prepreg between the two cores to be connected and then adding the drills with the sintering paste fill.

With the Drill Validation option disabled as described above, add the prepreg between layers 4 and 5 as shown below.



Add mechanical drills between layers 4 and 5 and specify the fill type as Sintering Paste.

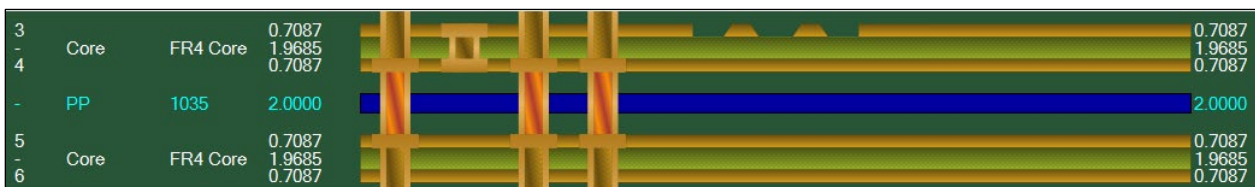

Edit the Prepreg Properties to reflect the interconnect.

Supplier Description	Prepreg 1035 + Ormet 701
Description	1035 + Ormet 701

Design rule checking

Speedstack includes facilities to check for errors in stackup design, such as layers placed in invalid order or asymmetrical structures. The condition of the design rule checkboxes is carried over from session to session.

The Design Rule Checker (DRC) displays results in the DRC dialog. As each design rule is broken Speedstack increments the error count on the DRC tab.

Viewing design rule errors

Click the DRC tab to view errors.

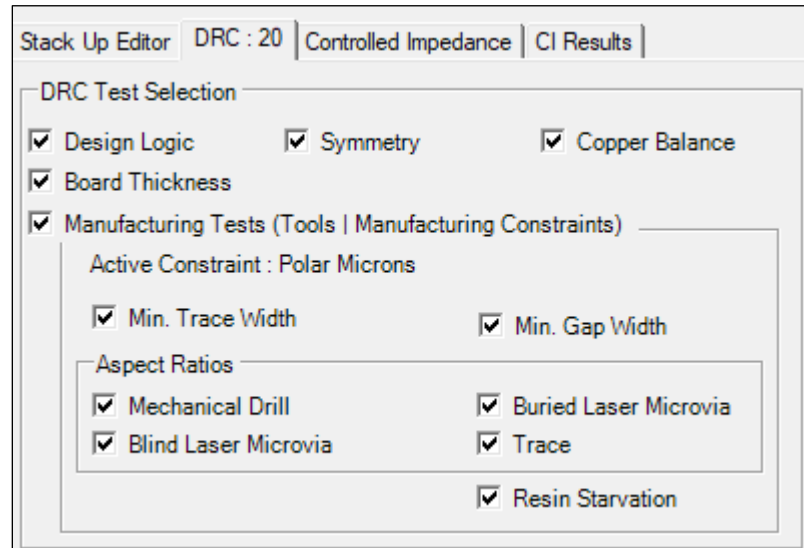

The Design Rule Checker checks include checking for:

- Two adjacent copper layers
- Resin coated copper on internal layer
- External prepreg layers
- Internal solder mask material
- Internal ident material
- Internal peelable mask
- Symmetry – different material types
- Copper not balanced
- Board thickness (if the board is outside tolerance the Stack Information in the Stack editor is displayed in red)

Manufacturing tests

- Minimum trace width (the test is carried out when calculating controlled impedance)
- Minimum trace separation (the test is carried out when calculating controlled impedance)
- Drill aspect ratios for plated holes
- Track aspect ratio
- Excess resin test (Resin Starvation)

If the Resin Starvation check box is ticked, values are shown as below; scroll through the layers as required

Layer	Resin
1	10134.3%
2	
3	2757.1%
4	

Note: If the Resin Starvation check box is ticked, all prepregs must include valid values for the excess resin field.

Polar Application Note [AP509](#) includes a discussion on calculating excess resin.

Users can choose to display all errors or to select from a combination of design errors, symmetry errors and copper balance errors, etc.; check the boxes as required.

Click on the errors shown in the list to highlight the errors in the stackup screen.

Resin Level Low:	-100.0%
Resin Level Low:	-100.0%
Resin Level Low:	-100.0%
Resin Level Low:	-100.0%

Errors are highlighted in red.

1	Foil	Copper Foil	1.400	▲	▲	▲	▲	▲	▲	▲	
-	PP	PrePreg 1080	3.000	■							3.000
2	-	Core	0.700	■							8.000
-		FR4 Core	8.000	■							8.000
3			0.700	■							

Correcting design rule errors

Users are strongly recommended to work through and correct errors in the order in which the errors are listed. Note that clearing each error may clear other errors in the process.

Manufacturing tests should be fixed before sending the PCB for manufacture. Hole sizes should be adjusted to comply. Failures with track and gap should be corrected, possibly by changing prepreg thickness and/or dielectric constants.

A collection of manufacturing constraints can be defined and the required one selected.

Creating and using manufacturing constraints

From the Tools menu, select Manufacturing Constraints: the Manufacturing Constraints window opens, displaying any manufacturing constraints added. By default, there will always be at least one.

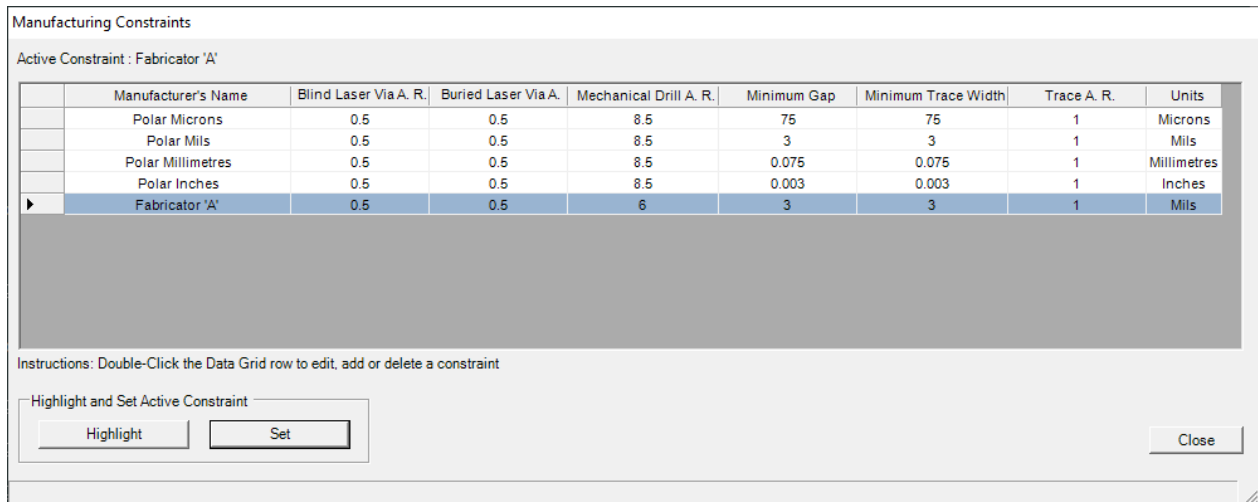

It is important to always have one constraint set active.

To set the active constraint, select the required data grid row and click Set. The active constraint is shown above the grid.

The Active Constraint name in the example Manufacturing Constraints list above is displayed as shown below so the current selected set of Manufacturing Constraints is easily identifiable

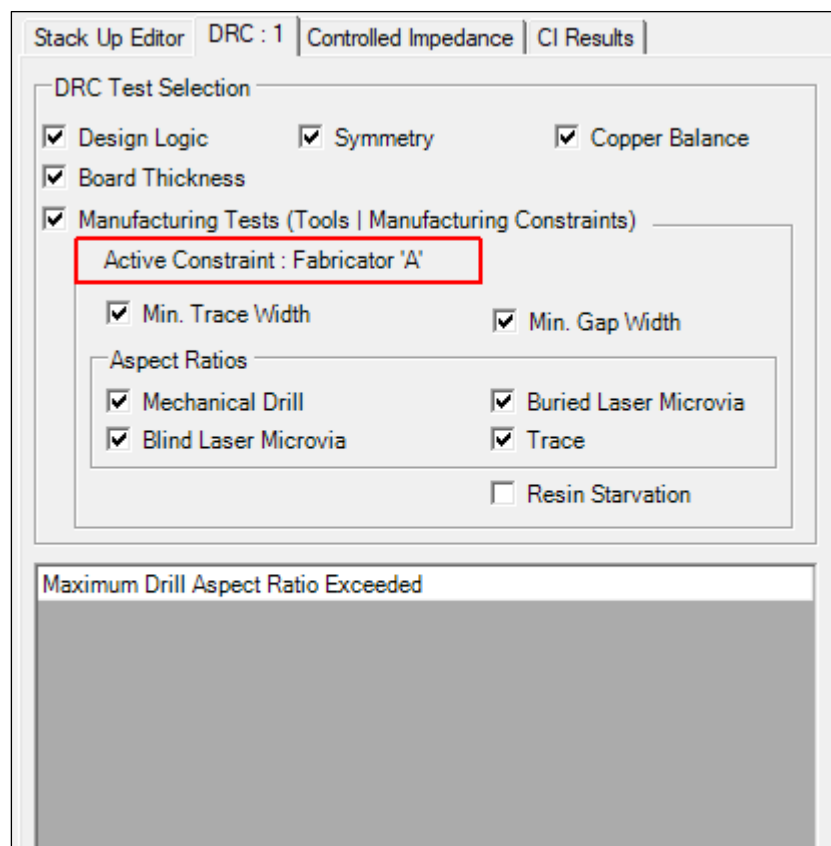

DRC errors are listed below the rules. Clicking the error will highlight the problem graphically on the stackup

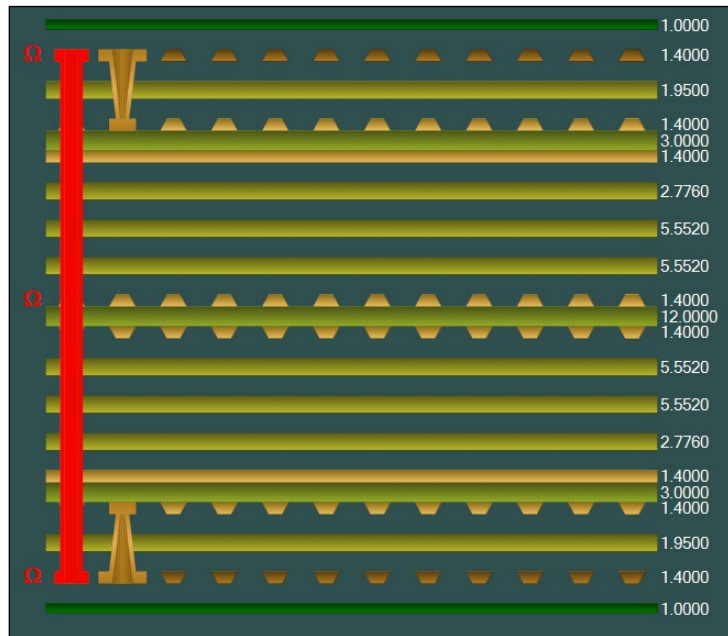

In the above example the Design Rule Checker reports:
Fabricator A Maximum Drill Aspect Ratio Exceeded

The associated drill is highlighted in the Stackup Editor

Editing constraints

Double-click on a constraint row will bring up the Edit Constraints dialog; use the dialog to add, delete or edit constraints (gaps, trace widths, aspect ratios, etc.)

Edit Constraints

Units

Mils Microns

Inches Millimetres

Option Name

Minimum Gap

Minimum Trace Width

Mechanical Drill A.R.

Blind Via A.R.

Buried Via A.R.

Trace A.R.

5 of 5

Instructions

Add: Press Add, which will add a new blank constraint. Notice the 'n of n' record number will increase. Now key in the constraint details and select Done.

Delete: Press Delete to remove the existing constraint. Notice the 'n of n' record number will reduce. Then select Done to close the dialog.

Edit: Edit the existing constraint and select Done to close the dialog.

To edit a constraint set, use the navigation buttons to select the set to be modified, change the values as required and then press Done.

To delete a constraint set, use the navigation buttons to select the set, then press Delete.

To add a new constraint set, press the Add button, this will add a new (empty) constraint row, enter the name and constraint values and press Done.

Adding controlled impedance structures

Speedstack incorporates the facility to add controlled impedance structures to a layer in the stackup.

Each structure can be assigned up to five net class names. These net class names provide a link to the matching impedance nets inside the ECAD PCB layout system.

Speedstack Si caters for frequency dependent calculations, adding comprehensive insertion loss capability into Speedstack.

Speedstack is integrated with the Polar Instruments Si8000m/9000e controlled impedance field solvers so impedance values for a structure may be calculated at the click of a button.

Structure parameters may be copied to the field solver for processing (for example by the Si8000m/9000e Goal Seeking function) and calculated values pasted back into Speedstack for insertion into the stackup.

Bidirectional copy and paste from Speedstack Si into Si9000e includes all the relevant loss tangent, roughness and roughness modelling methods along with frequencies of interest.

Shield materials and controlled impedance / insertion loss

Please note:

Speedstack is capable of supporting many shield types for stack up design and documentation. For controlled impedance and insertion loss applications, however, it is important to use the correct type of shield material.

Shield materials are often designated by the shield vendor as *For high speed signal transmission applications*.

Adding a controlled impedance structure

For the example stack below, add a controlled impedance structure to signal layer 4.

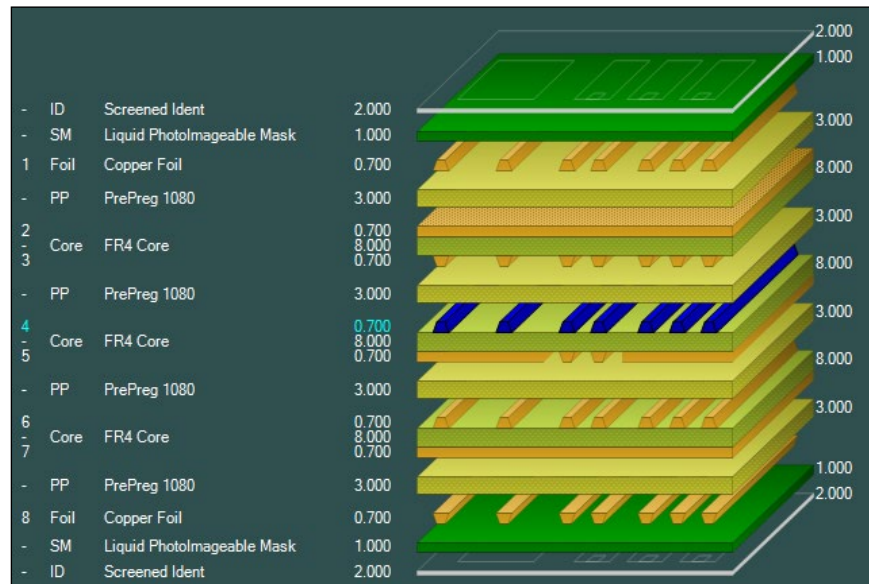

Sample stackup (showing signal layer 4 selected)

Note that in this example Layer 5 is a mixed signal/plane layer. Potential reference planes for Signal Layer 4 are therefore Plane Layer 2, mixed Signal/Plane Layer 5 and plane Layer 7.

With Layer 4 selected, click the Controlled Impedance tab. The Add Structure button is displayed.

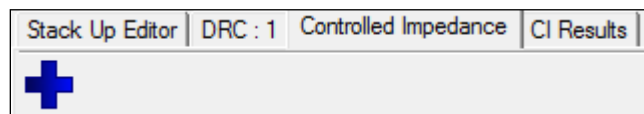

Click the Add Structure button; the Structure Control dialog is displayed containing the controlled impedance structures applicable to the selected layer in the stack. Choose values for the target impedance and tolerance. If necessary, resize the Structure Control dialog to view all structures.

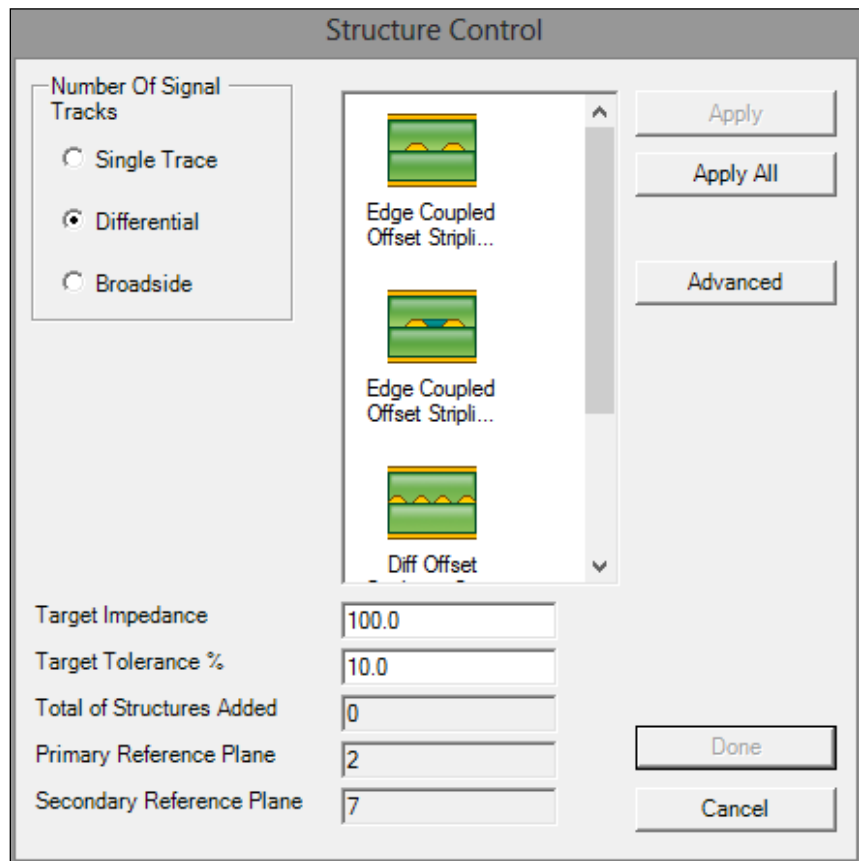

Click the Single Trace, Differential or Broadside option button as appropriate (in this case, choose Single Trace|Offset Stripline 1B1A with a 50 Ohm impedance.)

Note: Broadside only appears as an option where the signal trace is between two reference planes and Differential is selected.

Specify the values for Target Impedance and Tolerance.

Note that attempting to add structures that would break design rules will result in the error message below:

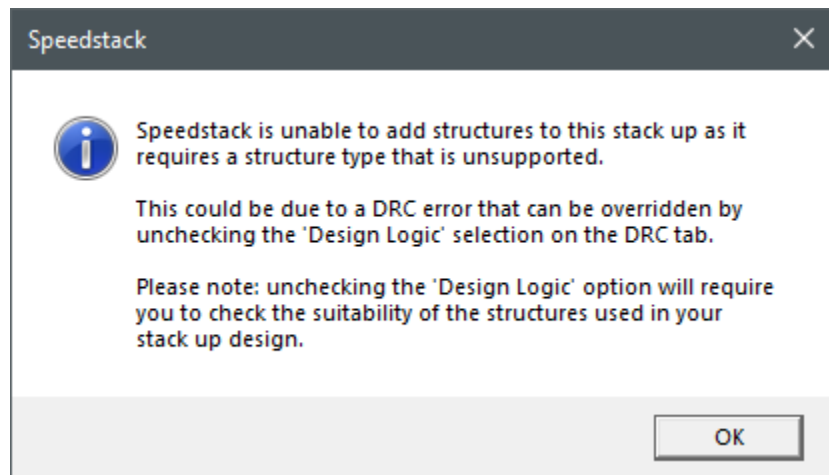

Choosing reference planes

As there are multiple reference planes available (layers 2, 5 and 7), it will be necessary to specify which planes to use for this structure. Click Advanced.

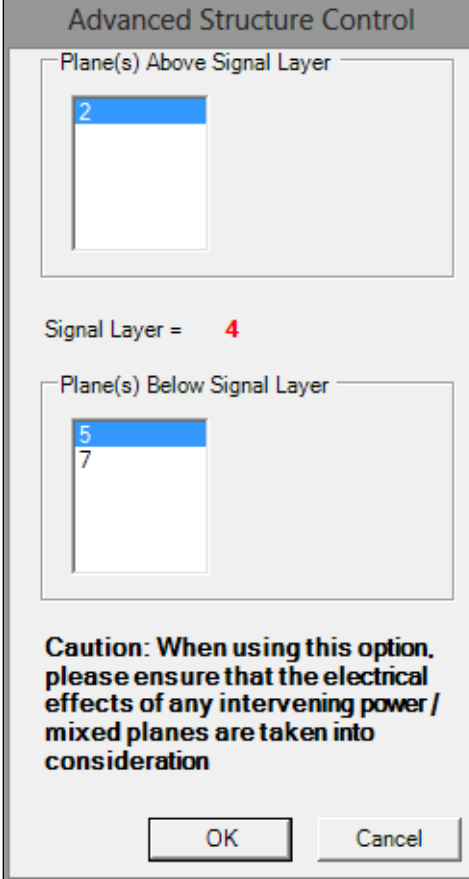

The dialog box titled "Advanced Structure Control" contains the following elements:

- A list box labeled "Plane(s) Above Signal Layer" with the number "2" selected.
- A label "Signal Layer = 4" where "4" is in red.
- A list box labeled "Plane(s) Below Signal Layer" with the numbers "5" and "7" listed, and "5" selected.
- A caution message: "Caution: When using this option, please ensure that the electrical effects of any intervening power / mixed planes are taken into consideration".
- Buttons for "OK" and "Cancel".

Choose a reference plane from the list of available planes. In the example structure plane layer 2, mixed plane 5 and plane layer 7 are available for reference.

Note: if plane layer 7 is chosen as reference, it will be necessary to take into account the electrical effects of mixed signal/layer plane 5.

In this example choose mixed signal/plane layer 5. Press OK to confirm. The chosen reference planes are shown below.



The summary dialog box shows the following configuration:

Total of Structures Added	1	Done
Primary Reference Plane	2	
Secondary Reference Plane	5	

Repeat for all structures to be added. Click Apply for each structure then click Done to finish. In this example, choose a single structure.



Layers with controlled impedance structures are indicated by a red Ohms symbol.

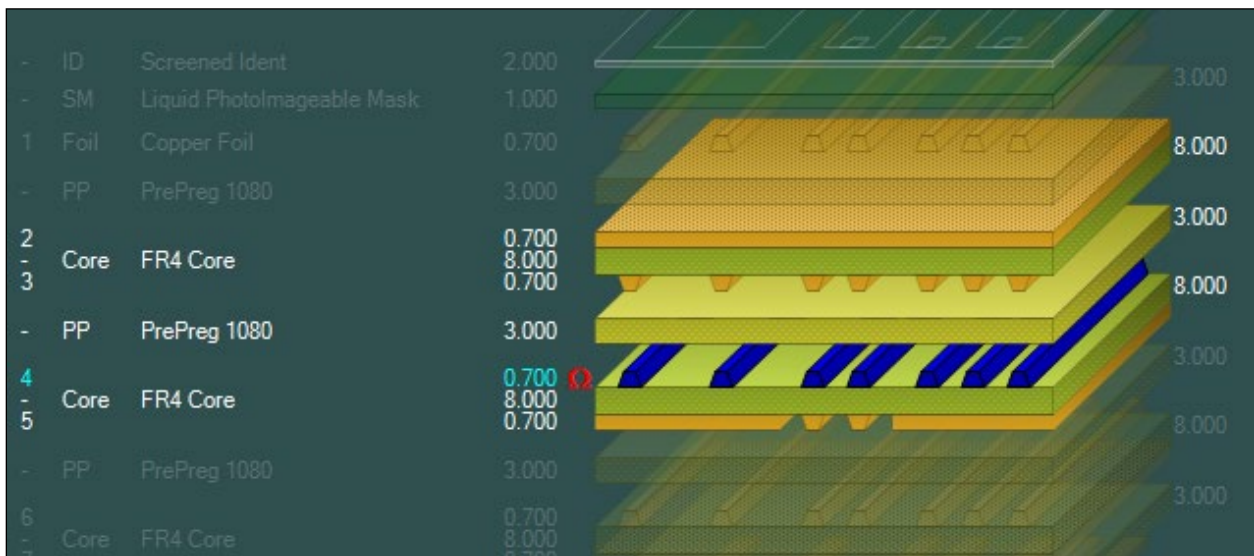

The stackup window changes to reflect the selected signal layer and its associated reference planes. The applied structure is displayed in the Controlled Impedance pane.

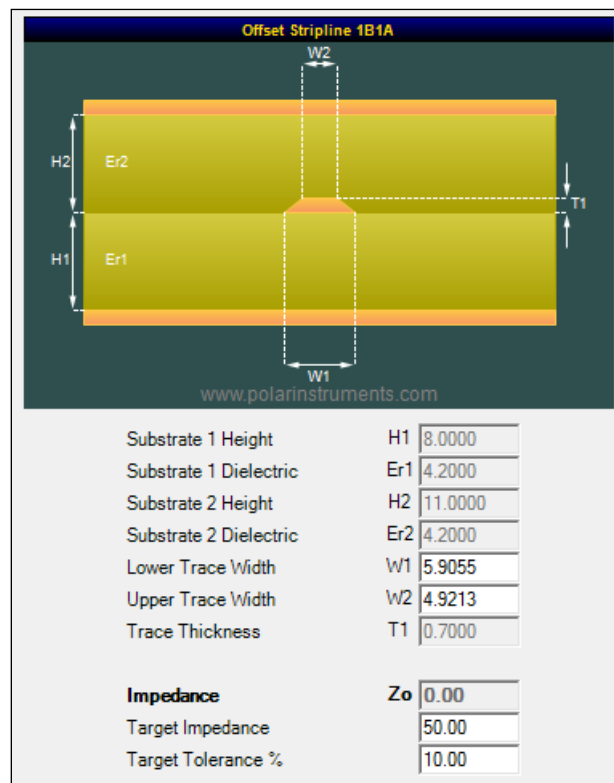

The window displays the parameters of the controlled impedance structure. Fields shown "greyed out" are values derived from the choice of materials in the stackup. For this structure, enter the appropriate values for lower and upper trace widths.

Controlled impedance toolbar

Controlled impedance operations are performed via the Controlled Impedance toolbar – activated when a controlled impedance structure is added to the stackup.



Add controlled impedance structure to current layer



Delete structure from current layer



Clear all structures from current layer



Rebuild and recalculate all structures



Calculate displayed structure



Snap parameters and calculate structure



More calculations – provides additional field solver results for the selected structure within the stack. Results depend upon the structure – single-ended or differential.



Mirror structures



Goal seek



Set CITS test



Free hand notes



Structure layer properties



Structure validation



Structure net classes



Frequency dependent properties



Original structure values

Structure Browse Control

Use the structure browse control to display the structure on each layer and navigate through the structures

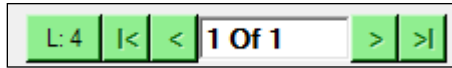

Calculate Displayed Structure



Calculate Displayed Structure

Click the Calculate Displayed button to display the impedance value of the structure with the current parameters. The parameters may then be varied to alter the value of the final impedance. In the example above the trace width can be fine-tuned in order to approach the value of the target impedance; other parameters are changed by modifying the stackup dimensions (for example, core thickness, H1.)

Hint: clicking Apply All in the Structure Control dialog adds a single instance of all structures matching the stackup layer and the chosen criteria; the designer can then choose the structure producing the value nearest the target impedance and delete the structures that are not needed.

Snap Parameters and Calculate Structure



Snap Parameters and Calculate Structure

The Snap Parameters and Calculate Structure button snaps or rounds parameters to practical values that are more appropriate for fabrication.

The Snap feature supports the following structure parameters:

- Lower Trace Width (W1)
- Upper Trace Width (W2)
- Lower Ground Strip Width (G1)
- Upper Ground Strip Width (G2)
- Trace Separation (S1)
- Ground Strip Separation (D1)
- Trace Offset (O1)

The Snap To value for each parameter is held in the configuration settings (in the example below, 0.25 mils.) See *Configuring Speedstack – Structure Defaults*.

Lower Trace Width	W1	7.6500
Upper Trace Width	W2	6.6500
Trace Separation	S1	8.1150

Original parameter values

Lower Trace Width	W1	7.7500
Upper Trace Width	W2	6.7500
Trace Separation	S1	8.0000

Snapped parameter values

Displaying More Calculations



Click the More Calculations button – *more calculations* provide additional field solver results for the selected structure within the stack. Note that the More Calculation

More calculations

option is an on-demand calculation that will only be run if the More Calculations results are requested.

Results displayed depend upon the structure – single-ended or differential.

Calculations include

Single ended:

- Impedance
- Delay
- Inductance
- Capacitance
- Effective dielectric constant
- Velocity of propagation

Differential:

- Differential impedance
- Odd mode impedance
- Even mode impedance
- Common mode impedance
- Odd mode delay
- Effective dielectric constant
- Velocity of propagation
- Near end crosstalk (NEXT)
- Coupling percentage.

Note: The Delay, Inductance and Capacitance results will be presented per inch or per metre based upon the Speedstack units selected

More Calculations are included on printed technical reports which optionally also include insertion loss graphs for user-nominated structures.

Single ended calculations include impedance, delay, inductance and capacitance, effective dielectric constant and velocity of propagation – see single-ended dialog below

Impedance	Zo	75.802	Close
Delay (ps/m)	D	5994.939	
Inductance (nH/m)	L	454.428	
Capacitance (pF/m)	C	79.087	
Effective Dielectric Constant	EEr	3.230	
Velocity of Propogation (CITS)	Vp	0.556	

More single-ended calculations

Differential calculations include differential impedance, odd mode delay, odd mode and even mode impedance, common mode impedance, effective dielectric constant, velocity of propagation, near-end crosstalk and coupling percentage – see differential dialog below.

Differential Impedance	Zdiff	100.289	Close
Delay (Odd Mode) (ps/m)	D	5814.283	
Odd Mode Impedance	Zodd	50.144	
Even Mode Impedance	Zeven	67.086	
Common Mode Impedance	Zcommon	33.543	
Effective Dielectric Constant	EEr	3.038	
Velocity of Propogation (CITS)	Vp	0.574	
Near-End Crosstalk (NEXT)	Kb	7.2257E-02	
Coupling Percentage	CP	7.226	

More differential calculations

Presentation of the More Calculation results match the Polar Si8000m and Si9000e products

The More Calculation results have been added to the Technical Report (File|Print Technical Report) as user selectable Controlled Impedance Table columns. Including these columns will entail on-demand field solving calculations that will only be run if required.

Changing parameter values

Clicking the Calculate function yields a value for impedance. parameters (for example, the dielectric height may be amended to yield a value for impedance closer to the target impedance.)

As an example, select the core layers; click the Swap Selected Material button and choose a different core (ensure the same dimensional units are used throughout the structure) and click the Refresh and Calculate Impedance button. The impedance is recalculated to its new value.

To achieve an impedance acceptably close to the target impedance, use the goal seeking function of the field solver to alter other parameters (in this case, change the upper and lower trace widths).

Goal seeking with Speedstack

Speedstack provides the facility to solve for horizontal parameters (e.g. trace width and separation, ground strip separation, etc.) to produce the target impedance (or calculate that the target impedance is unachievable with the current values).



Click the Goal Seek button to display the Set Up GoalSeek dialog; the options available will depend on the controlled impedance structure.

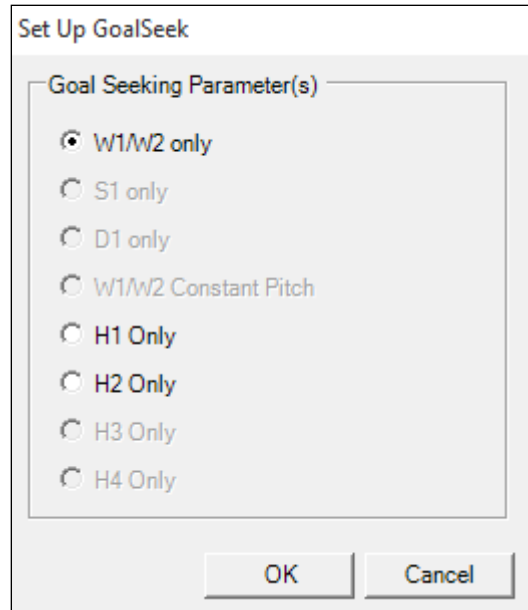

Click OK; the Speedstack attempts to arrive at the target impedance by iteratively modifying the specified parameters. It may be necessary to add or delete prepregs to achieve the target impedance.

Goal seeking with the Si8000m/9000e

Speedstack Stackup Builder is fully integrated with the Si8000m/Si9000e Controlled Impedance Field Solvers. Users can transfer Stackup layer dimensions to the Field Solver, solve for stackup parameters to produce the target impedance (or calculate that the target impedance is unachievable with the current values) then transfer the solved dimensions back to Speedstack.

Ensure the Field Solver is running and that its units match the Speedstack units.



To Field Solver

With the stackup parameters displayed in the Controlled Impedance window, click To Field Solver to transfer the current Speedstack parameters to the Si8000m/Si9000e.



Paste from Speedstack

Switch to the field solver and click the Paste from Speedstack button to load the parameters into the associated field solver fields. The field solver reflects the structure and parameters of that selected in Speedstack.

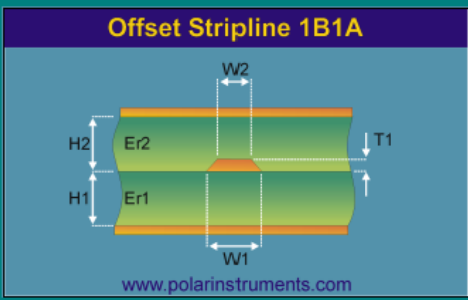

			Tolerance	Minimum	Maximum	
Substrate 1 Height	H1	6.0000	± 0.0000	6.0000	6.0000	Calculate
Substrate 1 Dielectric	Er1	4.2000	± 0.0000	4.2000	4.2000	Calculate
Substrate 2 Height	H2	9.0000	± 0.0000	9.0000	9.0000	Calculate
Substrate 2 Dielectric	Er2	4.2000	± 0.0000	4.2000	4.2000	Calculate
Lower Trace Width	W1	5.9978	± 0.0000	5.9978	5.9978	
Upper Trace Width	W2	5.0136	± 0.0000	5.0136	5.0136	Calculate
Trace Thickness	T1	0.7000	± 0.0000	0.7000	0.7000	Calculate
Impedance	Zo	50.00		50.00	50.00	Calculate

For the data shown above seek a final value for impedance of 50 Ohms; H1, Er1 and T1 are fixed, so goal seek on W1,W2.

Click the Upper Trace Width (W2) Calculate button to goal seek on trace width. The field solver returns new values for trace width to produce 50 Ohms final impedance.

Lower Trace Width	W1	5.9907	± 0.0000	5.9907	5.9907	
Upper Trace Width	W2	4.9907	± 0.0000	4.9907	4.9907	Calculate



Copy to Speedstack



From Field Solver

Click the Copy to Speedstack button, switch to Speedstack and click the From Field Solver button to display the solved parameters for the target impedance.

Note: it may be necessary to round some dimensions (for example, the dielectric heights) to the nearest practical values and recalculate the impedance.

Changing layer functionality

It is often convenient to base a new design on an existing stackup and then add or remove electrical layers to create the new stack, leaving the previous existing structures intact or to switch between layer types (Signal, Plane, Mixed, Hatched) without removing structures.

Speedstack allows the designer to retain and re-allocate structures when changes are made to the electrical layers of the stackup. This enables reallocation of structures after the following stackup changes:

Adding foils and/or cores – increasing the layer count

Deleting foils and/or cores – reducing the layer count

Moving foils and cores up and down, even beyond another copper layer – maintaining the layer count but, for example, exchanging two different thickness cores within the stackup

Copying and pasting foil or core – increasing the layer count

Changing layer type – signal to plane, plane to signal, mixed to signal or plane, signal to hatch, hatch to signal

Deleting a rigid core and adding a flex core – to maintain layer count but swapping material type

Deleting a rigid core and adding two foils – to maintain layer count but switching to an HDI type build

For the following examples, consider the stack below.

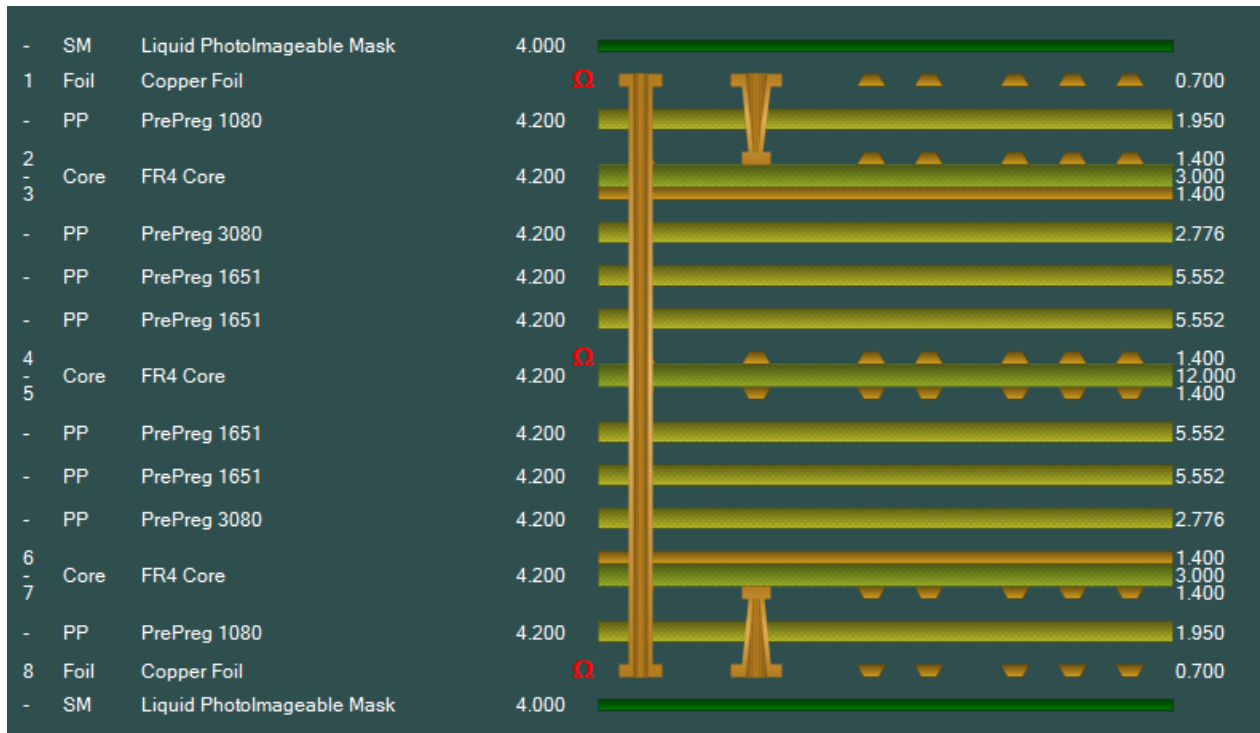

Switching layer types and reallocating structures



Switch signal layer 2 to a plane layer and plane layer 3 to a signal layer. Speedstack issues a warning indicating that continuing with the change will require the existing structures to be re-allocated.

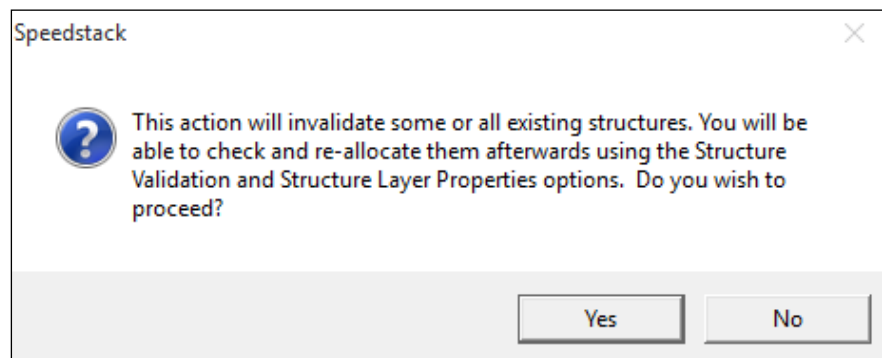

Select Yes to confirm the change to the stackup. The stack editor reflects the change in the stackup, layer 2 is a plane layer and layer 3 a signal layer.

-	SM	Liquid Photoimageable Mask	4.000		
1	Foil	Copper Foil		0.700	
-	PP	PrePreg 1080	4.200	1.950	
2	Core	FR4 Core	4.200	1.400	1.400
3				3.000	1.400
-	PP	PrePreg 3080	4.200	2.776	
-	PP	PrePreg 1651	4.200	5.552	

Speedstack also displays a flashing Rebuild indicator; due to the changes to the stackup it is necessary to refresh the structures.

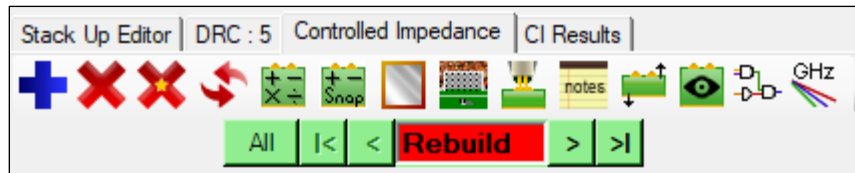

Rebuild and Recalculate

Click the Rebuild and Recalculate icon – Speedstack displays an information dialog indicating which structures need re-allocating.

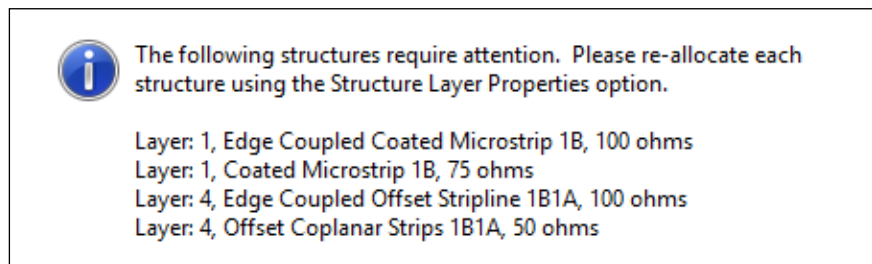

Click OK then click the Structure Layer Properties icon to reallocate the structures to the correct signal and plane layers.

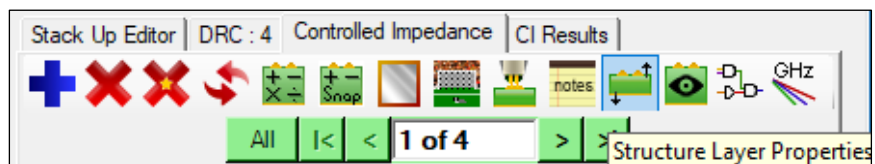

The Structure Layer Properties dialog includes two layer columns, the Current layer column and the New layer column. The Current column shows the Signal / Plane stackup layers assigned to the structure before the stackup was changed.

The New column allows the structure to be re-allocated to reflect the new stackup layer types.

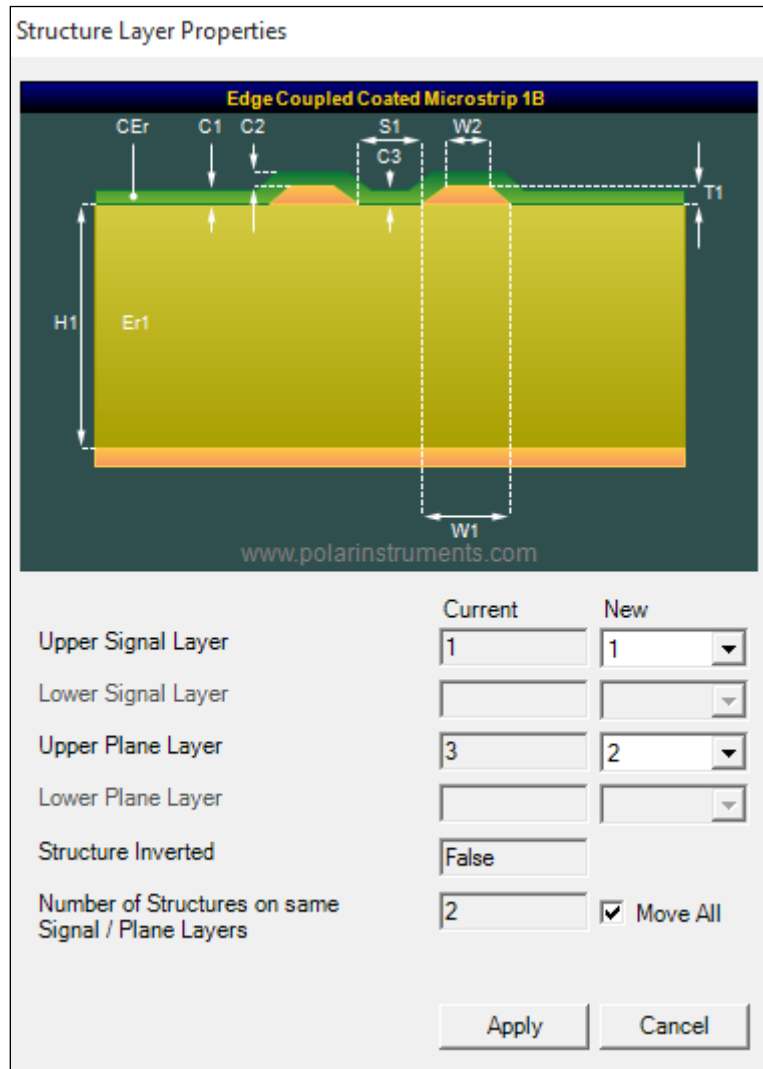

In this case notice the Upper Plane Layer is changed from layer 3 to layer 2.

In many cases multiple structures will have the same Signal / Plane layer assignments. In the example above Speedstack indicates that there are two structures affected. Click the Move All check box to re-allocate all matching structures in a single operation then click Apply.



Rebuilding the stack indicates that other structures (i.e., the two structures on layer 4) also require layer reallocation.

-	PP	PrePreg 1651	4.200		5.552
4	-	Core	FR4 Core	4.200	1.400
5	-	PP	PrePreg 1651	4.200	1.400
-	PP	PrePreg 1651	4.200		5.552



The following structures require attention. Please re-allocate each structure using the Structure Layer Properties option.

Layer: 4, Edge Coupled Offset Stripline 1B1A, 100 ohms
 Layer: 4, Offset Coplanar Strips 1B1A, 50 ohms



Structure Layer Properties

Use the structure selection arrow keys to step through to the structures on layer 4 then click Structure Layer Properties.

Structure Layer Properties

Edge Coupled Offset Stripline 1B1A

www.polarinstruments.com

	Current	New
Upper Signal Layer	4	3
Lower Signal Layer		
Upper Plane Layer	3	2
Lower Plane Layer	6	6
Structure Inverted	False	
Number of Structures on same Signal / Plane Layers	2	<input checked="" type="checkbox"/> Move All

Reallocate the layers as required then click Apply. With the structures re-allocated Rebuild and Calculate the structures as described earlier.

Note that structure Trace Width and Separation parameters are retained at their original values together with the Target Impedance and Tolerance. (Depending upon how the structures have been re-allocated it may be necessary to go back and seek the trace width and separation parameters to meet the target impedance.)

Increasing the layer count

It is a common requirement for designers to base a new design on an existing proven stackup and then add or remove electrical layers to create a new stack, leaving the previous existing structures intact.

Consider the 8 layer stack below.

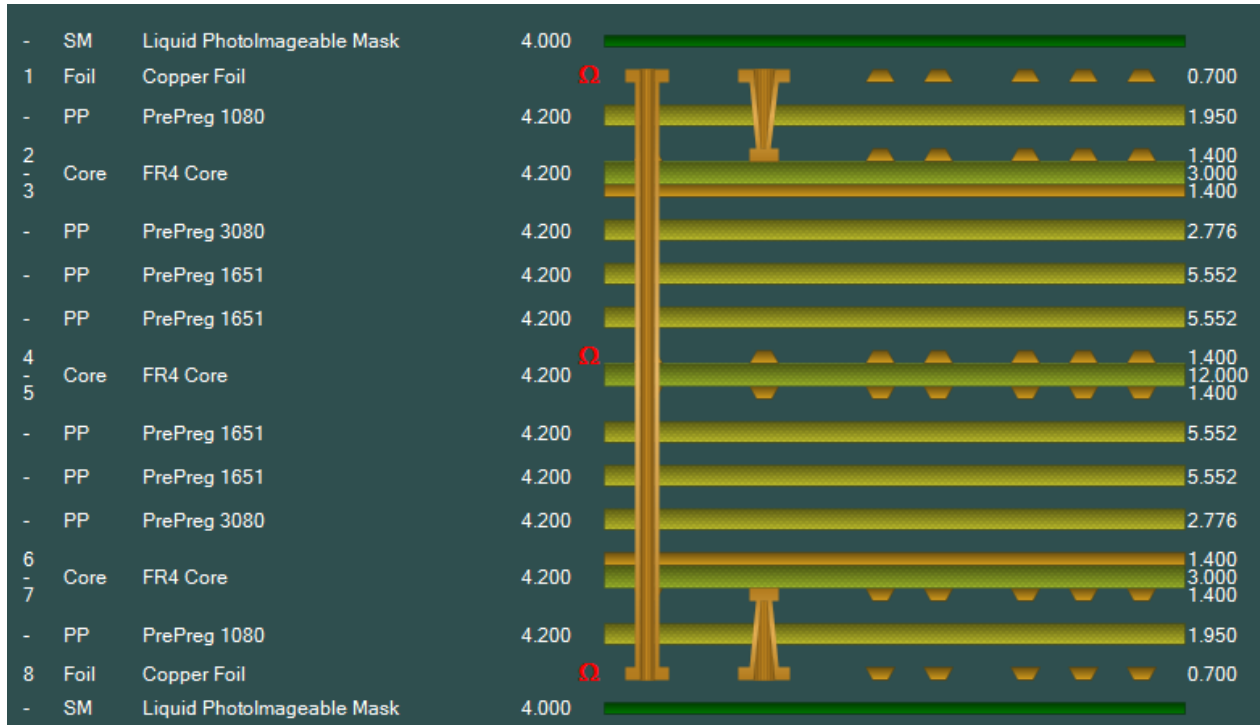

For this example, add a core between layers 5 and 6.

Speedstack will display a warning that proceeding with the change will require the existing structures to be reallocated.

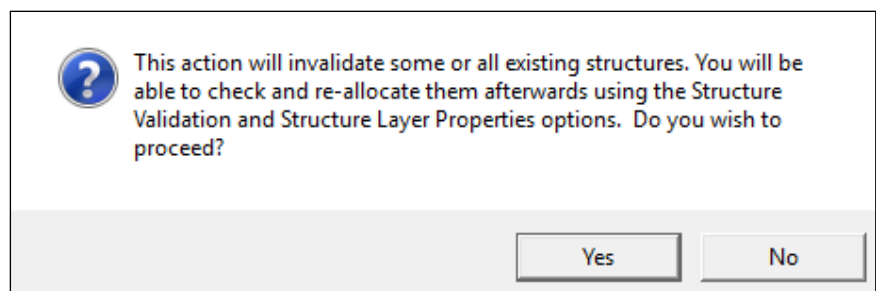

Click Yes to proceed.

In order to maintain a symmetrical stack, delete the Prepreg 3080 materials and add Prepreg 1651 materials to create a symmetrical 10 layer stack.

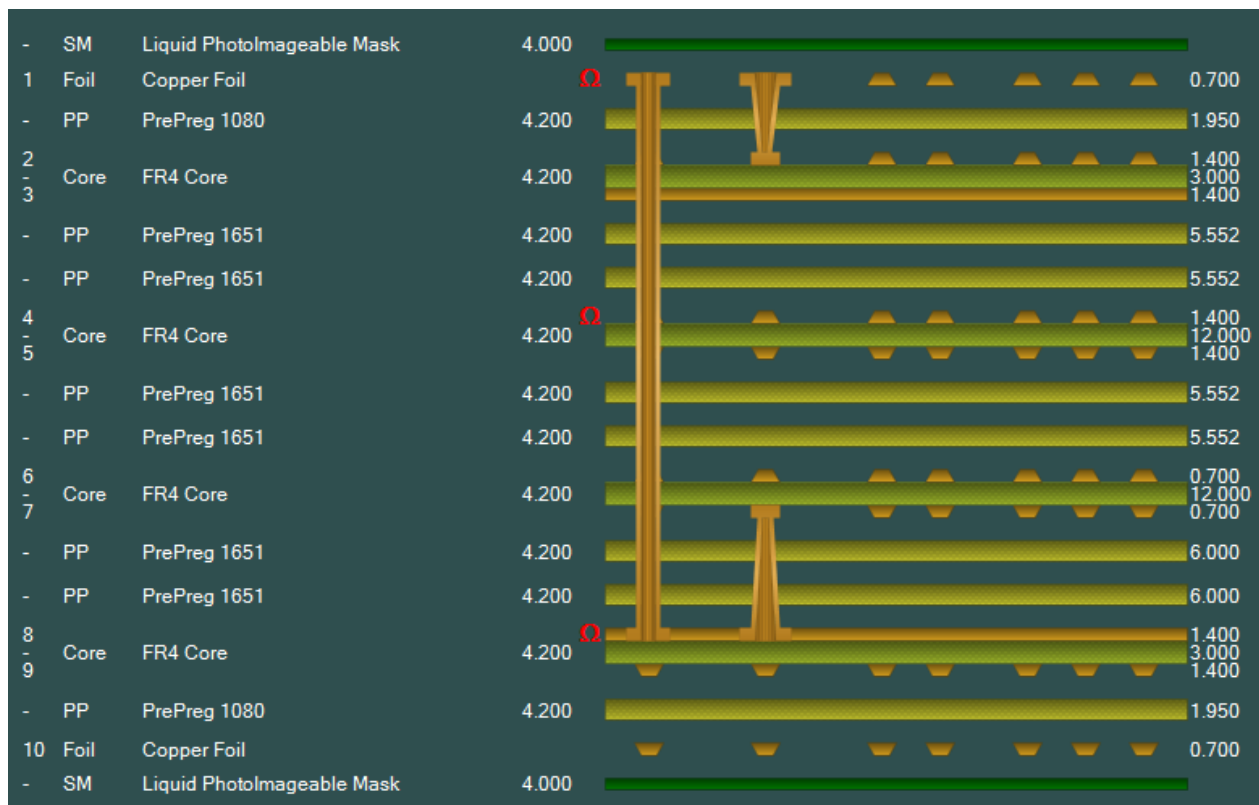

Rebuild and Recalculate

Click Rebuild and Recalculate

Speedstack displays an information dialog indicating the structures that need reallocating.

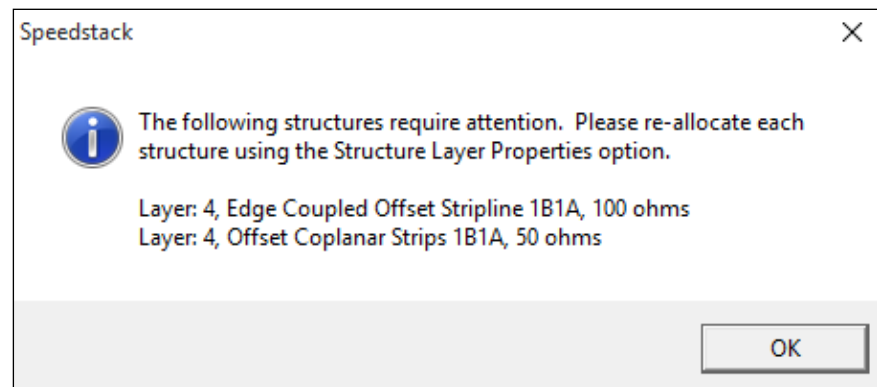

Click OK.

Use the structure navigation buttons to select the structure layer then click the Structure Layer Properties button to display the Structure Layer Properties dialog.

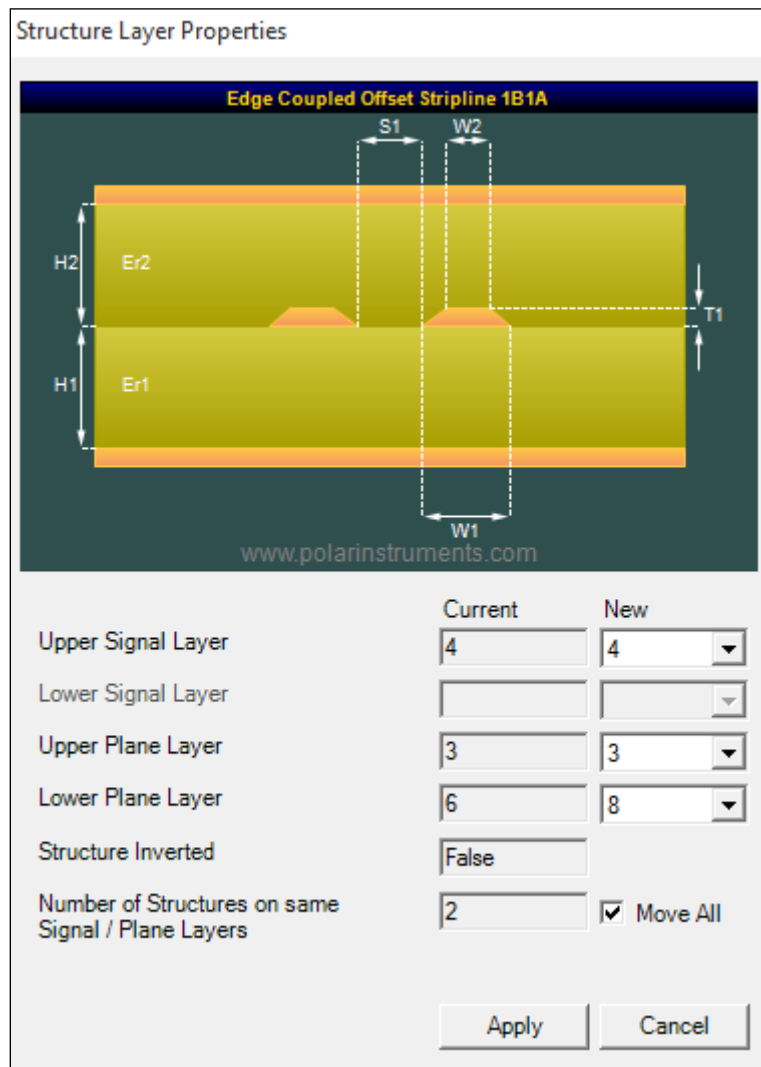

Note that for the modified stack the lower plane layer has been reallocated to layer 8.

Click Apply and then Rebuild and Recalculate.

If necessary, goal seek on line widths to bring the impedance within specification.

For the above stack edit the Drill Properties to finalise the stack changes.

Repeat the procedure for each structure as necessary.

Structure net classes

Speedstack allows up to five Net Class names to be stored with each structure. These net class names provide a link to the matching impedance nets inside the ECAD PCB layout system. Net classes are supported in Speedstack's import / export file formats.

Net class columns can be selected for display on the technical report.

To display the Structure Net Classes dialog click the Net Classes button



Net classes

Enter the net class names in the text boxes and click Apply.

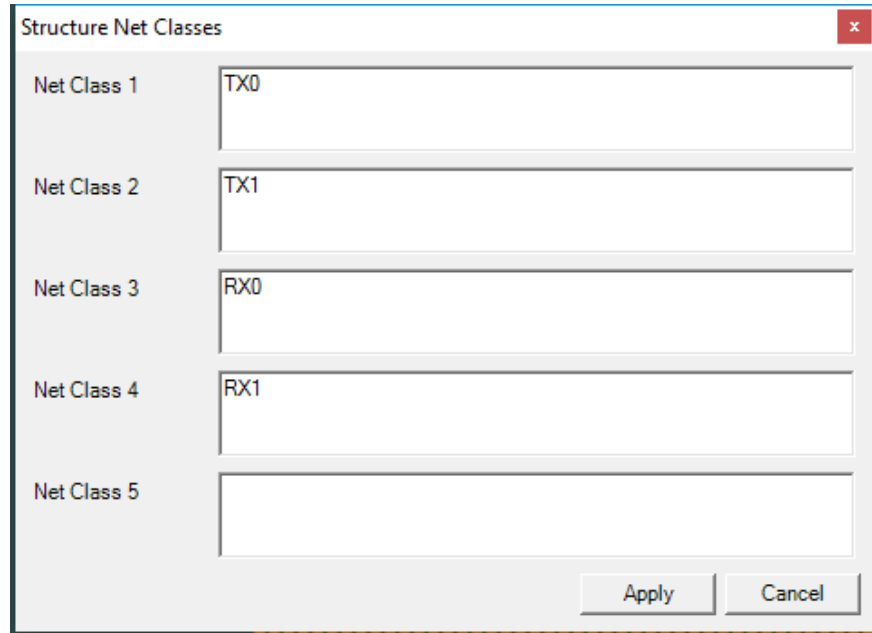

Up to five net class names may be stored with each structure.

Click the Select Impedance Columns button and Select the Net Class columns to display the net classes on the Speedstack technical report.



Select Impedance Columns

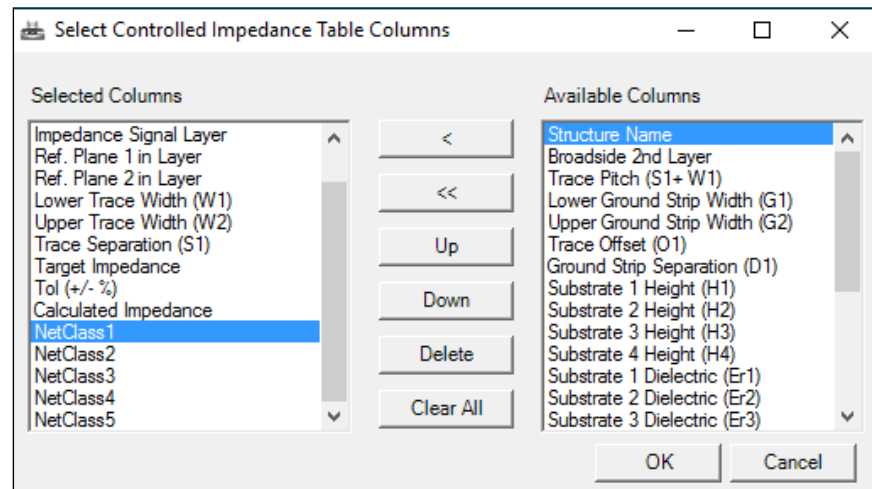

The chosen columns are displayed in the selected order.

Impedance ID	Structure Image	Impedance Signal Layer	Ref. Plane 1 in Layer	Ref. Plane 2 in Layer	Lower Trace Width (W1)	Upper Trace Width (W2)	Trace Separation (S1)	Target Impedance	Tol (+/- %)	Calculated Impedance	NetClass1	NetClass2	NetClass3	NetClass4	NetClass5
1		1	3	0	8.224	7.224	8.391	100.000	10.000	99.930	TX0	TX1	RX0	RX1	

Original Structure Values

When a stackup design arrives for fabrication, the requested structure trace widths and separation values often have to be adjusted, on a per structure basis, by the fabricator.

Speedstack's Original Structure Values feature ensures that the requested parameter values as specified by the designer are retained.

Thus, even if goal seeking is used to arrive at new parameter values, the original structure values are not overridden, but remain available for reference.

The Original Structure Values feature is implemented on the subset of Speedstack's structures listed below.

Coated Microstrip 1B

Edge-Coupled Coated Microstrip 1B

Coated Coplanar Strips with Ground 1B

Coated Coplanar Waveguide with Ground 1B

Diff Coated Coplanar Strips with Ground 1B

Embedded Microstrip 1B1A

Edge Coupled Embedded Microstrip 1B1A

Edge Coupled Embedded Microstrip 1B1A1R

Offset stripline 1B1A

Offset Coplanar stripline 1B1A

Offset Coplanar Waveguide stripline 1B1A

Edge Coupled Offset Stripline 1B1A

Edge Coupled Offset Stripline 1B1A1R

Diff Offset Coplanar Waveguide 1B1A

Offset Stripline 2B2A

Edge Coupled Offset Stripline 2B2A

The original structure values dialog

The original structure values dialog is shown below.

Original Structure Values			
Original Lower Trace Width	W1	<input type="text" value="8.0000"/>	Apply Cancel
Original Upper Trace Width	W2	<input type="text" value="7.0000"/>	
Original Trace Separation	S1	<input type="text" value="7.7650"/>	
Original Lower Ground Strip Width	G1	<input type="text" value="0.0000"/>	
Original Upper Ground Strip Width	G2	<input type="text" value="0.0000"/>	
Original Ground Strip Separation	D1	<input type="text" value="0.0000"/>	

Within the dialog the original structure trace width and separation values can then be viewed or edited.

The original trace width and separation values for the selected structure are shown highlighted below.

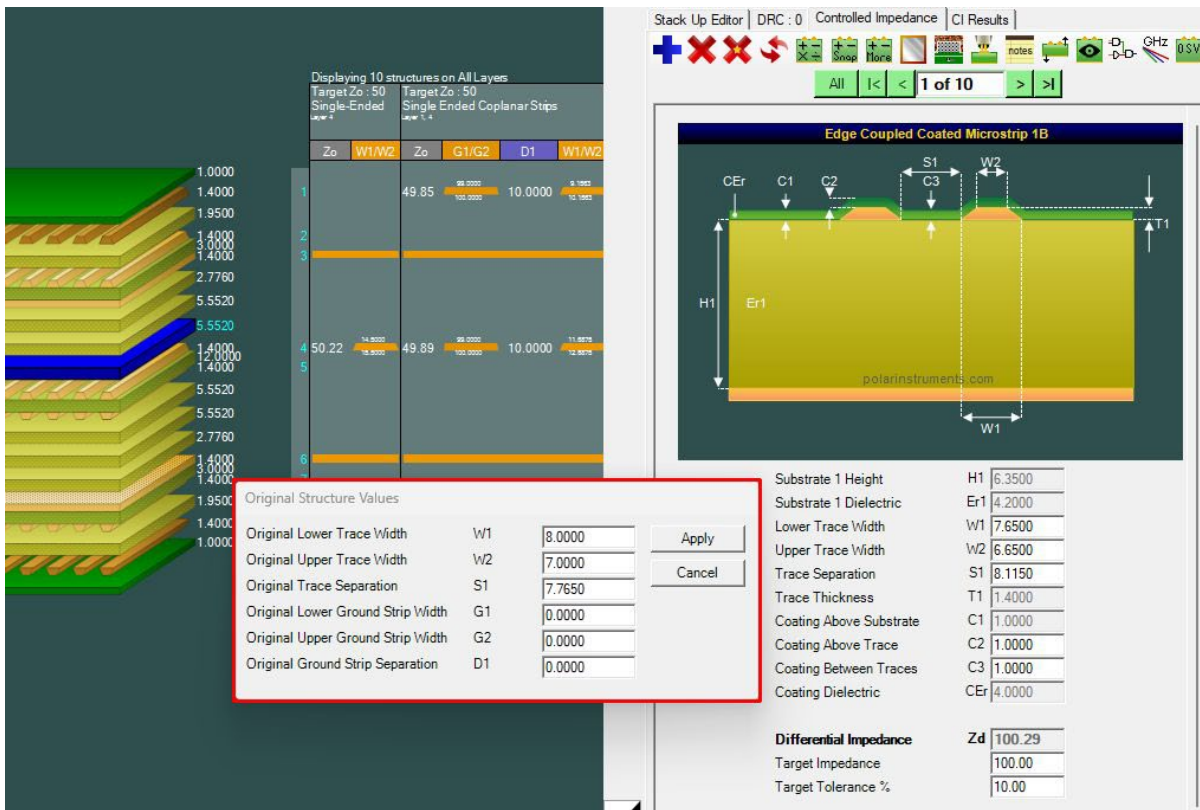

Displaying the original structure values



Original Structure Values

Use the Original Structure Values icon from the Controlled Impedance Tab tool bar to display the Original Structure Values dialog – below.

The original structure trace width and separation values will then be accessible to be viewed or edited.

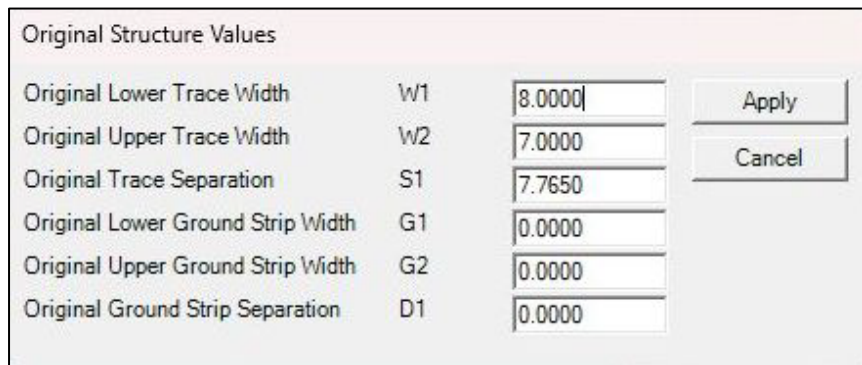

Note that parameter values unused by the structure are shown as zero.

Displaying original structure values in the Technical Report

The original structure values may be included as selectable columns for the Structure Table on the Technical Report, so the report will contain *before* and *after* values. Use the Select Controlled Impedance Table Columns dialog to select and position the original parameter values

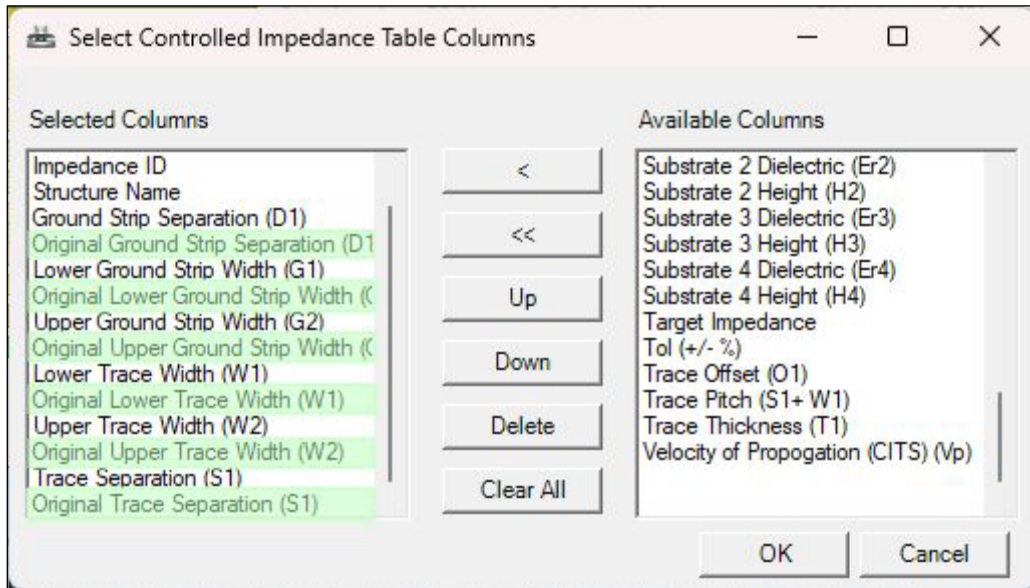

The original parameter values are shown (highlighted) alongside the current active values

Layer	Stack up	Supplier	Supplier Description	Description	Type	Processed Thickness	Cr	Copper Layer Type
1		Polar Samples	SM/001	Liquid Photolimageable Mask	SolderMask	1,000	4,000	
		Polar Samples	FO/001	Copper Foil	Copper	1,400		Signal
2		Polar Samples	PP/001	PrePreg 1080	Dielectric	1,950	4,200	
3		Polar Samples	CO/005	FR4 Core	FR4	1,400	4,200	Signal
		Polar Samples	PP/002	PrePreg 3080	Dielectric	2,776	4,200	
		Polar Samples	PP/004	PrePreg 1651	Dielectric	5,552	4,200	
		Polar Samples	PP/004	PrePreg 1651	Dielectric	5,552	4,200	
4		Polar Samples	CO/020	FR4 Core	FR4	1,400	4,200	Signal
		Polar Samples	PP/004	PrePreg 1651	Dielectric	5,552	4,200	
		Polar Samples	PP/004	PrePreg 1651	Dielectric	5,552	4,200	
		Polar Samples	PP/002	PrePreg 3080	Dielectric	2,776	4,200	
5		Polar Samples	CO/005	FR4 Core	FR4	1,400	4,200	Plane
		Polar Samples	PP/001	PrePreg 1080	Dielectric	1,950	4,200	
		Polar Samples	FO/001	Copper Foil	Copper	1,400		Signal
8		Polar Samples	SM/001	Liquid Photolimageable Mask	SolderMask	1,000	4,000	

Copper Thickness = 11.200 | Dielectric Thickness = 49.660 | Solder Mask Thickness = 2.000 | Stack Up Thickness = 60.860 | Stack Up Thickness with Soldermask = 62.860

Structure Image	Impedance ID	Structure Name	Ground Strip Separation (D1)	Original Ground Strip Separation (D1)	Lower Ground Strip Width (G1)	Original Lower Ground Strip Width (G1)	Upper Ground Strip Width (G2)	Original Upper Ground Strip Width (G2)	Lower Trace Width (W1)	Original Lower Trace Width (W1)	Upper Trace Width (W2)	Original Upper Trace Width (W2)	Trace Separation (S1)	Original Trace Separation (S1)
	1	Edge Coupled Coated Microstrip 1B	0.000	0.000	0.000	0.000	0.000	0.000	7.650	8.000	6.650	7.000	8.115	7.765
	2	Coated Microstrip 1B	0.000	0.000	0.000	0.000	0.000	0.000	4.000	4.500	3.000	3.500	0.000	0.000
	3	Diff Coated Coplanar Strips With Lower Ground 1B	10.000	15.000	100.000	90.000	99.000	89.000	9.313	9.500	8.313	8.500	15.688	15.500
	4	Coated Coplanar Strips With Lower Ground 1B	10.000	9.000	100.000	90.000	99.000	89.000	10.156	10.000	9.156	9.000	0.000	0.000
	5	Edge Coupled Offset Stripline 1B1A	0.000	0.000	0.000	0.000	0.000	0.000	7.250	7.000	6.250	6.000	8.500	8.750

StackName: Master	Version:	Revision:	Modification:	Date of Revision:	Editor
Date:	Associated Documents:				
Author:					
Department:					
Site:					

Copyright © Print style & presentation copyright © Polar Instruments Ltd

Working with Si Projects in Speedstack and Si8000m/Si9000e

Si Projects

The Si Projects feature incorporated in Speedstack and Si8000m/Si9000e allows for easy transfer of controlled impedance structures from the Speedstack stackup design tool into the Si8000m and Si9000e field solvers.

Si Projects allows groups of structures to be saved and recalled in Si8000m/Si9000e and entire stackups of structures to be pasted from Speedstack into Si8000m and Si9000e with just a few clicks of the mouse.



To Si Project

The To Si Project toolbar icon copies a group of structures from Speedstack and places them onto the clipboard, these structures can then be pasted directly into the Si8000m or Si9000e Project group

Transferring structures from Speedstack to the field solver



The stackup below in Speedstack's Stackup Editor contains controlled impedance structures in the layers indicated by the Ohms symbol.

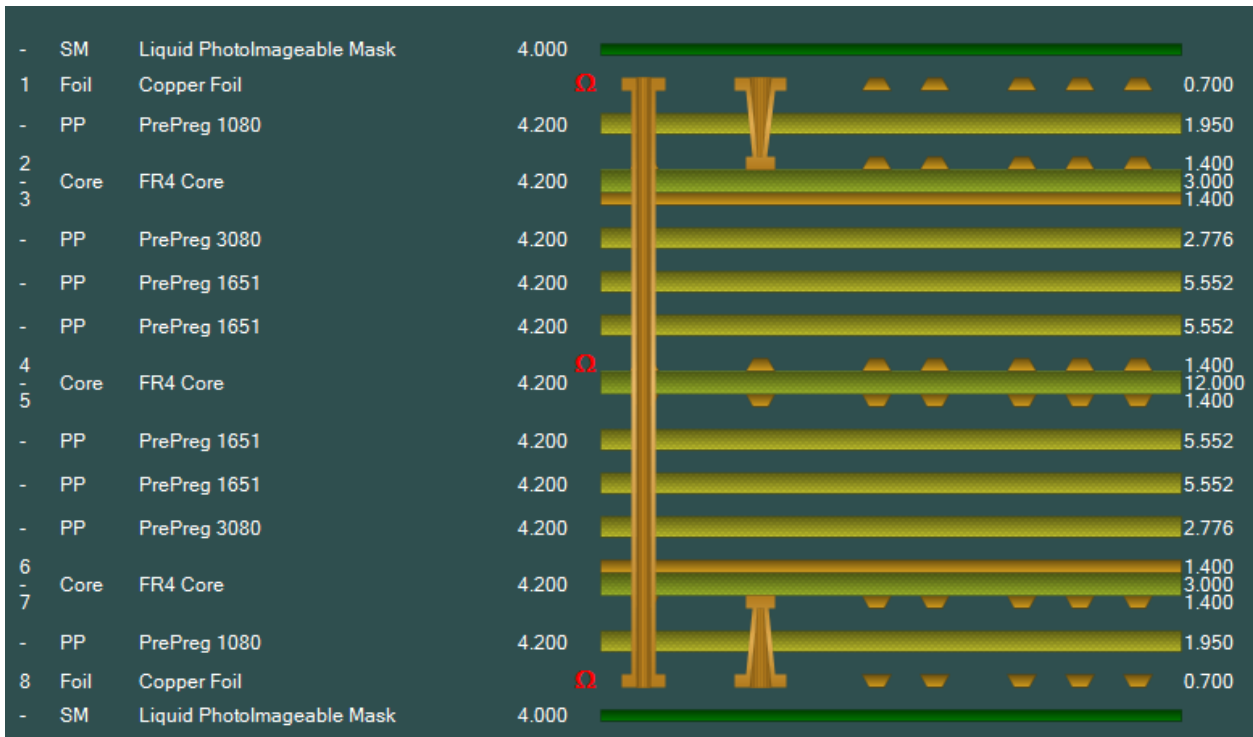

Click Speedstack's Controlled Impedance tab and use the structure navigation controls to step through and display the structures.

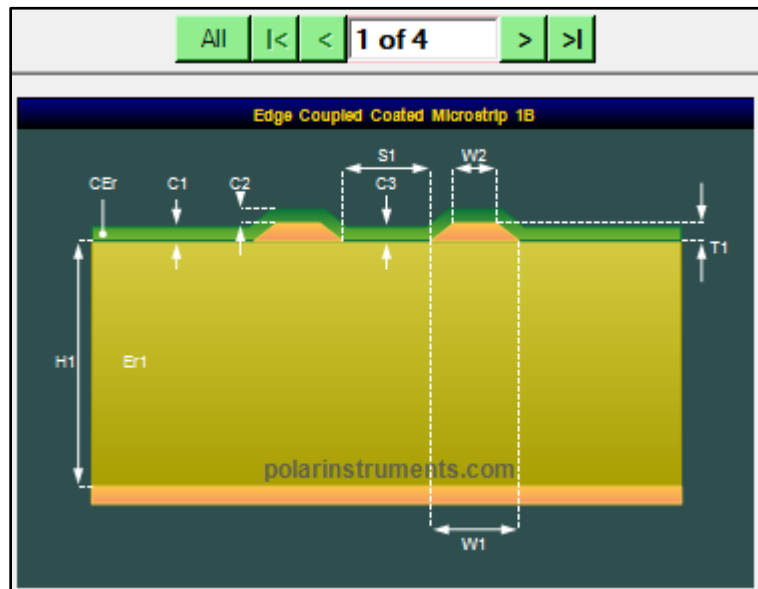

To Si Project

Use the Si Project toolbar buttons in the Speedstack and the Si8000m/Si9000e interface to transfer the structures via the Windows clipboard to the field solver.

Switch to the field solver and paste the structures from the clip board into the field solver Si project.

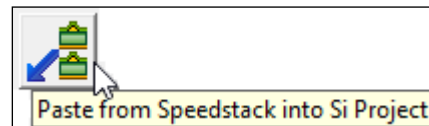

The complete set of structures appears in the field solver's Project window.

The Si Project window lists the transferred structures in layer order, showing the layer number and value along with a thumb nail graphic indicating the structure configuration. Right click on a structure in the structure list to view the structure options.

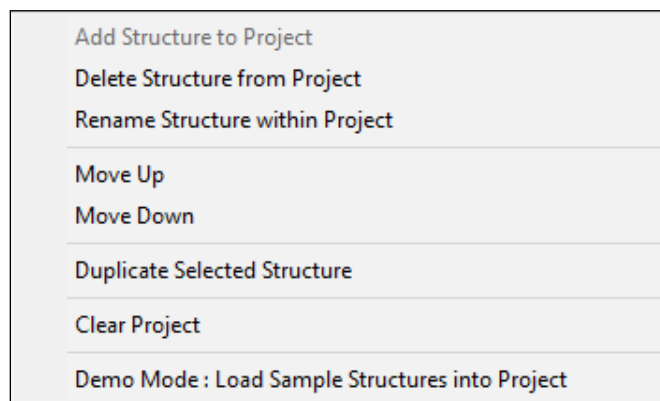

Adding/deleting and modifying structures

Selecting each structure displays its associated graphic in a grey background.

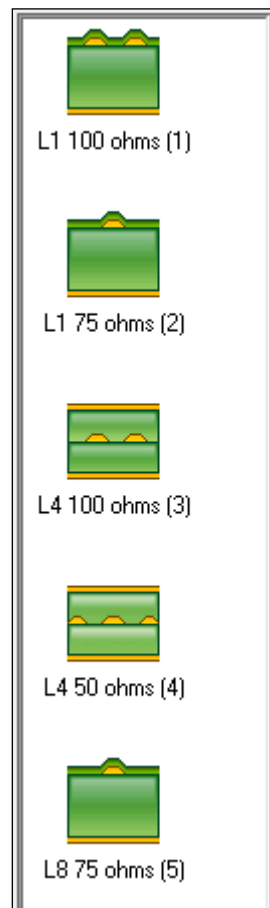

Click the + and – buttons in the structure graphic to add additional structures from the Si structure library or remove selected structures from the Project folder. Click the Rename Structure (the pencil icon) to assign the structure a descriptive name.

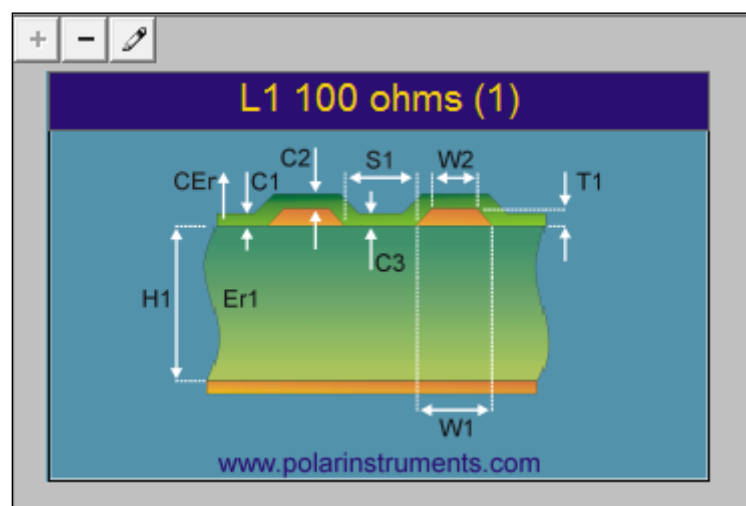

With a structure selected the structure parameters can be modified as required and the impedance recalculated.

Frequency dependent loss calculations (Speedstack Si only)

Note: Frequency dependent loss calculations are available in Speedstack only when used in conjunction with the Si9000e Insertion Loss Field Solver.

Speedstack Si (Speedstack Stackup Builder plus Si9000e Insertion Loss Field Solver) provides for calculations of frequency dependent loss given the information applicable to loss in the transmission line structure. The information includes material properties, comprising dielectric constant and loss tangent, conductor properties such as trace conductivity and surface roughness and the frequency range over which the transmission line structure will operate

Graphing against frequency is provided for impedance magnitude, conductor loss and dielectric loss (with or without roughness compensation,) inductance, capacitance, resistance, conductance and skin depth. Graphing for differential structures include differential, odd and even modes.



Frequency Dependent Properties

Each structure in the stack includes a set of frequency dependent properties.

Click the Frequency Dependent Properties icon to load the Frequency Dependent Properties dialog.

Frequency dependent parameters

Er and TanD properties for each substrate dielectric region

Surface roughness compensation models

Loss v frequency graph with conductor and dielectric losses

Interactive graph settings

The Frequency Dependent Properties dialog includes:

- the structure image of the selected structure
- frequency dependent parameters for the user defined frequency range and *frequency of interest*
- a table of substrate causal extrapolation reference points for each substrate dielectric/region
- surface roughness compensation model selection between Hammerstad, Grosse, Gradient, Huray and Simonovich-Cannonball methods
- the loss v frequency graph showing the data series for conductor and dielectric losses and total attenuation
- interactive graph setting with data point selection allowing drilling down to the underlying loss data
- data tables for the selected frequency range

Frequency Hz	Impedance Real Ohms	Impedance Imaginary Ohms	Impedance Magnitude Ohms	Inductance H/line	Resistance Ohms/line	Capacitance F/line	Conductance S/line	Skin Depth in	Conductor Loss dB/line	Dielectric Loss dB/line	Attenuation dB/line	Conductor Loss With Roughness dB/line	Attenuation With Roughness dB/line
5.000E-08	5.049E+01	-2.190E-01	5.049E+01	3.084E-08	2.518E+00	1.210E-11	6.579E-04	1.164E-04	-2.168E-01	-1.442E-01	-3.608E-01	-4.004E-01	-5.446E-01
1.000E+09	5.048E+01	-2.527E-02	5.048E+01	3.060E-08	3.547E+00	1.201E-11	1.316E-03	8.228E-05	-3.051E-01	-2.885E-01	-5.936E-01	-5.868E-01	-8.753E-01
1.500E+09	5.051E+01	6.176E-02	5.051E+01	3.050E-08	4.334E+00	1.195E-11	1.974E-03	6.718E-05	-3.726E-01	-4.331E-01	-8.057E-01	-7.261E-01	-1.159E+00
2.000E+09	5.054E+01	1.140E-01	5.054E+01	3.044E-08	4.998E+00	1.192E-11	2.633E-03	5.818E-05	-4.295E-01	-5.778E-01	-1.007E+00	-8.425E-01	-1.420E+00
2.500E+09	5.056E+01	1.499E-01	5.056E+01	3.039E-08	5.583E+00	1.189E-11	3.291E-03	5.204E-05	-4.795E-01	-7.227E-01	-1.202E+00	-9.443E-01	-1.667E+00
3.000E+09	5.059E+01	1.765E-01	5.059E+01	3.036E-08	6.112E+00	1.186E-11	3.950E-03	4.750E-05	-5.247E-01	-8.677E-01	-1.392E+00	-1.036E+00	-1.904E+00
3.500E+09	5.061E+01	1.974E-01	5.061E+01	3.034E-08	6.598E+00	1.184E-11	4.608E-03	4.398E-05	-5.662E-01	-1.013E+00	-1.579E+00	-1.120E+00	-2.133E+00
4.000E+09	5.063E+01	2.143E-01	5.063E+01	3.032E-08	7.051E+00	1.183E-11	5.267E-03	4.114E-05	-6.048E-01	-1.158E+00	-1.763E+00	-1.198E+00	-2.356E+00
4.500E+09	5.065E+01	2.255E-01	5.065E+01	3.031E-08	7.572E+00	1.181E-11	5.925E-03	3.879E-05	-6.492E-01	-1.303E+00	-1.953E+00	-1.287E+00	-2.591E+00
5.000E+09	5.067E+01	2.374E-01	5.067E+01	3.029E-08	7.985E+00	1.180E-11	6.584E-03	3.679E-05	-6.843E-01	-1.449E+00	-2.133E+00	-1.358E+00	-2.807E+00
5.500E+09	5.069E+01	2.478E-01	5.069E+01	3.028E-08	8.378E+00	1.178E-11	7.242E-03	3.508E-05	-7.178E-01	-1.594E+00	-2.312E+00	-1.425E+00	-3.020E+00
6.000E+09	5.070E+01	2.568E-01	5.070E+01	3.027E-08	8.753E+00	1.177E-11	7.901E-03	3.359E-05	-7.497E-01	-1.740E+00	-2.490E+00	-1.490E+00	-3.230E+00
6.500E+09	5.072E+01	2.648E-01	5.072E+01	3.026E-08	9.114E+00	1.176E-11	8.559E-03	3.227E-05	-7.804E-01	-1.885E+00	-2.666E+00	-1.551E+00	-3.437E+00
7.000E+09	5.073E+01	2.719E-01	5.073E+01	3.025E-08	9.461E+00	1.175E-11	9.219E-03	3.110E-05	-8.080E-01	-2.031E+00	-2.841E+00	-1.611E+00	-3.643E+00

Frequency dependent parameters

Speedstack Si runs a detailed analysis of the transmission line structure for controlled impedance and insertion loss. Each structure in Speedstack can store a complete set of frequency dependent parameters: Length of Lines, Frequency Minimum, Frequency Maximum, Frequency Steps, substrate data, surface roughness and loss budget. Supply the values in the dialog below.

Length of Line	LL	<input type="text" value="4000.0000"/>
Trace Conductivity (S/m)	TC	<input type="text" value="5.800E+07"/>
Frequency Minimum (MHz)	FMin	<input type="text" value="500.0000"/>
Frequency Maximum (GHz)	FMax	<input type="text" value="10.0000"/> <input type="button" value="Set..."/>
Frequency Steps	FStep	<input type="text" value="20"/>
Frequency of Interest (MHz)	Freq	<input type="text" value="5000.0000"/>
		<input type="button" value="Calculate"/>

Specify the line length and trace conductivity along with the frequency range and *frequency of interest*.

To specify the frequency range click the Set... button and enter the minimum frequency (in MHz) and maximum frequency (in GHz); specify the frequency increment (in MHz) then click Apply.

Frequency Entry			
Frequency Minimum (MHz)	FMin	500.0000	Apply Cancel
Frequency Maximum (GHz)	FMax	10.0000	
Frequency Increment (MHz)	FInc	100.0000	

With all parameters entered, click Calculate. Results are displayed in graphical and tabular form.

To provide for applications where the insertion loss requirements or loss budget specifications are needed for a given frequency the results for the specified frequency of interest are highlighted in green in the table of data.

Presentation of results

Use the Result Presentation dialog to choose units in which to present plots and tables of results.

Result Presentation		
<input checked="" type="radio"/>	Length of Line	
<input type="radio"/>	/in	
<input type="radio"/>	/m	

The graphs are able to display results in dB/line length, dB/inch or dB/metre.

Click the unit of choice and click Calculate to refresh the graphical display of data.

Graph settings

Use the Graph Settings dialog to choose the display series.

Speedstack Si graphs All Losses – conductor loss, dielectric loss and total attenuation.

Display Series	
All Losses	▼
All Losses	▲
Impedance Magnitude	
Inductance	
Resistance	
Capacitance	
Conductance	
Skin Depth	
Alpha	▼

If roughness compensation is applied the data series conductor loss with roughness and attenuation with roughness are added to the graph.

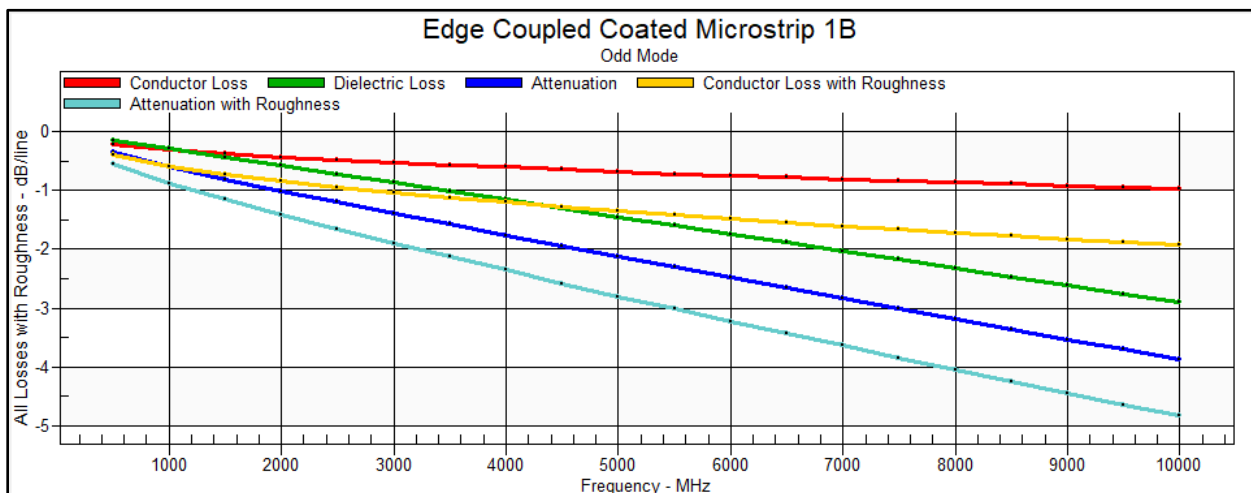

All losses with roughness

Speedstack charts are interactive. Click on a point on the data series of interest to display the data point value in the Picked Data Point Information text box

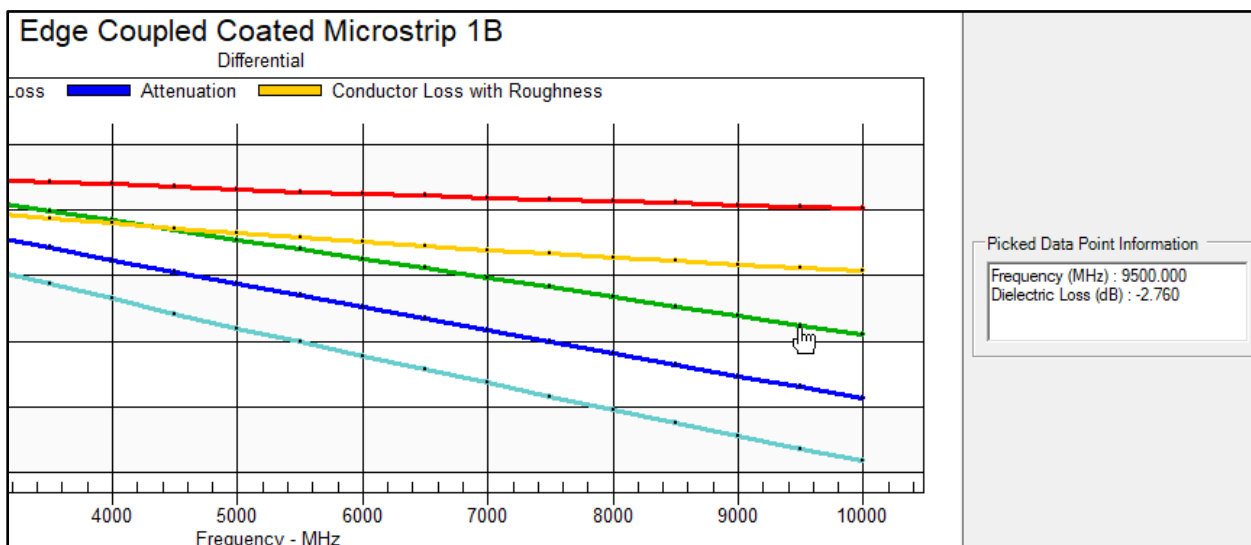

The range of data series includes losses, impedance magnitude, inductance, capacitance and skin depth: Choose the data series from the Display Series drop down.

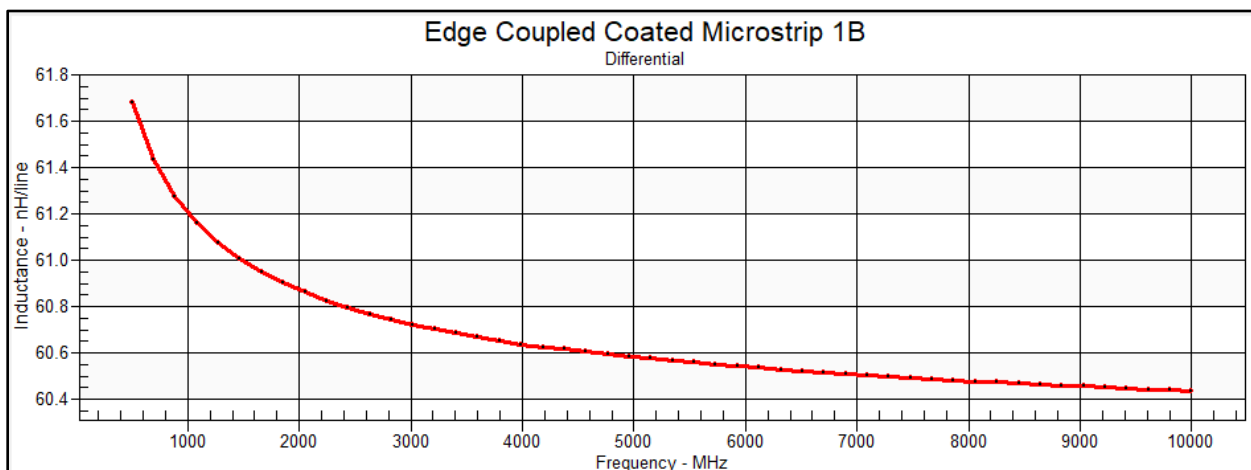

Graph of inductance v frequency

Displaying the loss budget

A value for loss budget can be added to a graph. A loss budget line will allow losses that exceed the budget to be easily identified.

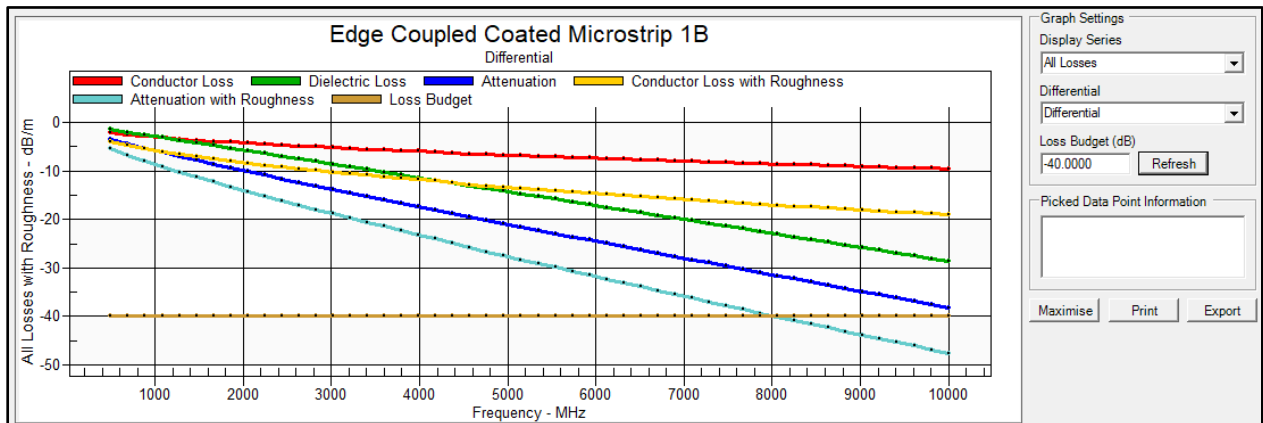

The plot above indicates that the loss budget is exceeded by the total attenuation (cyan) beyond 8000MHz (8GHz.)

Setting the Loss Budget stores the value with the structure for future use. This would prove useful if the stackups changed and it is necessary to ensure that the structure still meets the loss requirements after the changes.

Material and surface roughness properties

The Speedstack graph above charts all losses, the dielectric loss and the significant increase in the overall loss due to surface roughness, allowing the materials supplier to isolate the contributions of the different loss mechanisms.

Dielectric loss

In order accurately to calculate dielectric loss it is necessary to understand the material / substrate properties.

Speedstack Si allows substrate properties including dielectric constant (Er) and loss tangent (TanD) to be specified for each structure substrate region.

Substrate Causal Extrapolation Reference Points			
<input checked="" type="checkbox"/> Set Dielectric Constant (Er) from Stack Up materials			
<input checked="" type="checkbox"/> Set Loss Tangent (TanD) from Stack Up materials			
	Freq (Hz)	Ref Er	Ref TanD
H1	1.000E+09	4.2000	0.0195
H2			
H3			
H4			
REr			
CEr	1.000E+09	4.0000	0.0195

Speedstack Si causally extrapolates ϵ_r and $\tan\delta$ over the specified frequency range using a single value of ϵ_r and $\tan\delta$ to enable Svensson-Djordjevic frequency dependent permittivity modelling for each dielectric layer in the current controlled impedance structure. The table above therefore provides the ability to specify the extrapolation reference points for each substrate region; the reference point data is usually available from the material supplier data sheets. The values of ϵ_r and $\tan\delta$ can, optionally, be derived from the materials in the stack. (See the Polar Application Note [AP8184](#) or the Si9000e User Guide for a more detailed discussion of causally extrapolating substrate data.)

The fields shown active in the table in the dialog reflect the structure selected; inapplicable fields are shown greyed out.

The fields shown above allow values to be specified for the frequency of interest, the dielectric constant, ϵ_r , and loss tangent, $\tan\delta$, for the prepreg dielectric and the coating. Enter the parameters and click Calculate to refresh results.

Conductor losses – surface roughness compensation

In order to provide good adhesion between copper and dielectric materials in core layers PCB materials vendors control the roughness of the associated copper layers (typically by chemical treatment). Speedstack Si provides industry standard methods of compensation for surface roughness in frequency dependent calculations; the compensation methods include:

- Smooth copper, (no compensation for Cu loss at all)

- Hammerstad modelling

- Groisse modelling

- Gradient modelling

- Huray modelling – with Simonovich-Cannonball Model

Speedstack charts dielectric losses along with conductor losses and attenuation values that optionally include compensation for surface roughness. Roughness is a random quantity and is commonly specified in terms of the rms (root mean square) height h of the surface unevenness for the Hammerstad and Groisse compensation methods. Huray modelling is based on a non-uniform distribution of stacked copper nodules shapes resembling “snowballs”.

Surface roughness compensation methods

Accurate calculation of conductor loss requires the surface roughness parameters for each method:

The Smooth copper option provides for no compensation for copper loss.

Hammerstad modelling is a proven technique that has stood the test of time but has practical limitations when used over 4GHz as the model tends to saturate.

Groisse modelling can, with care, be used to extend the modelling up to 7 to 10 GHz before saturation in the model blunts its accuracy.

Hammerstad/Groisse/Gradient methods

To specify the roughness parameters for the Hammerstad, Groisse methods, click the option button for the method:

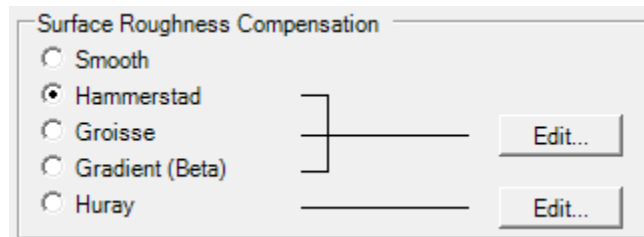

Click the Hammerstad/Groisse/Gradient Edit button.

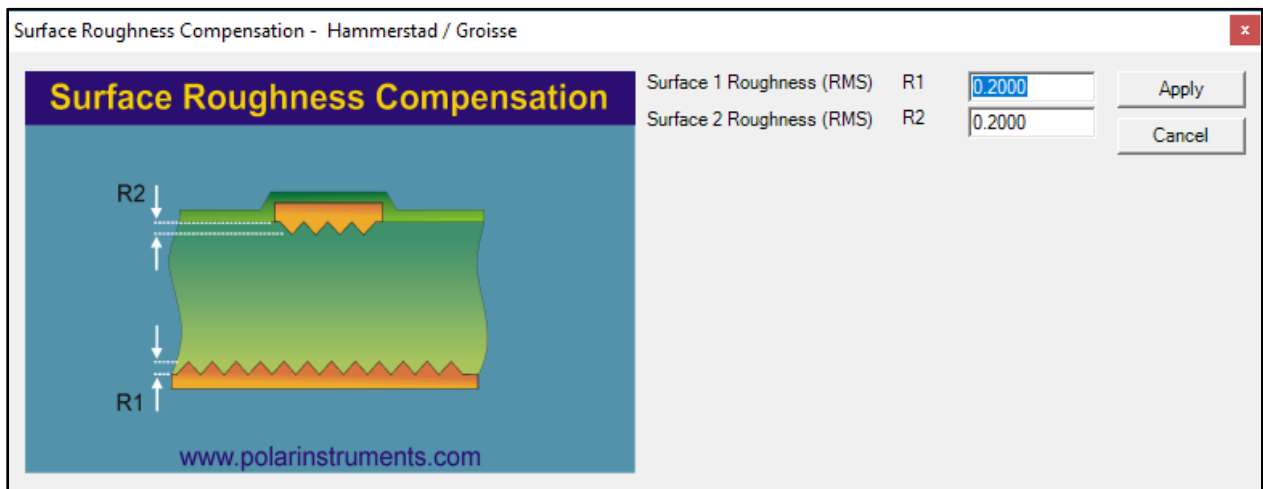

Enter the values for roughness in the R1 and R2 fields and click Apply. Click Calculate to refresh results.

Huray method – with Simonovich-Cannonball Model

Huray modelling extends the roughness modelling validity up to 40 to 50GHz (and possibly beyond).

Click the Huray option button:

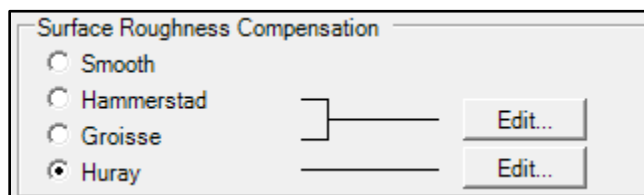

Click the Huray Edit button and specify the parameters for the Huray spheres (snowballs.)

Surface Roughness Compensation - Huray

Ratio of Areas: 1.0000
 Effective Ball Radius (µm): 0.7500
 Area of Ball Count (sq µm): 90.0000
 Number of Balls in Area: 32

Enable Simonovich-Cannonball

Matte-Side Roughness
 Rz Matte (µm): 4.4430

Drum-Side Roughness
 Rz Drum (µm): 3.0480

Calculate

Images by courtesy of Circuit Foil Luxembourg

Simonovich-Cannonball Model

Rz Matte-side
 Rz Drum-side

www.polarinstruments.com

Courtesy of Bert Simonovich, Lamsim Enterprises Inc [Application Note](#)

Supply the values in the associated fields and click Apply.

If the Huray values are not available, click Enable Simonovich-Cannonball and supply the Rz values for matte and drum side roughness and click Calculate to populate the Huray fields, then click Apply.

Click the Application Note link to access the paper *Practical Modelling of High-speed Channels Based on Data Sheet Input* (Bert Simonovich, LamSim Enterprises Inc.) which includes a description of roughness modelling using the Simonovich-Cannonball Model.

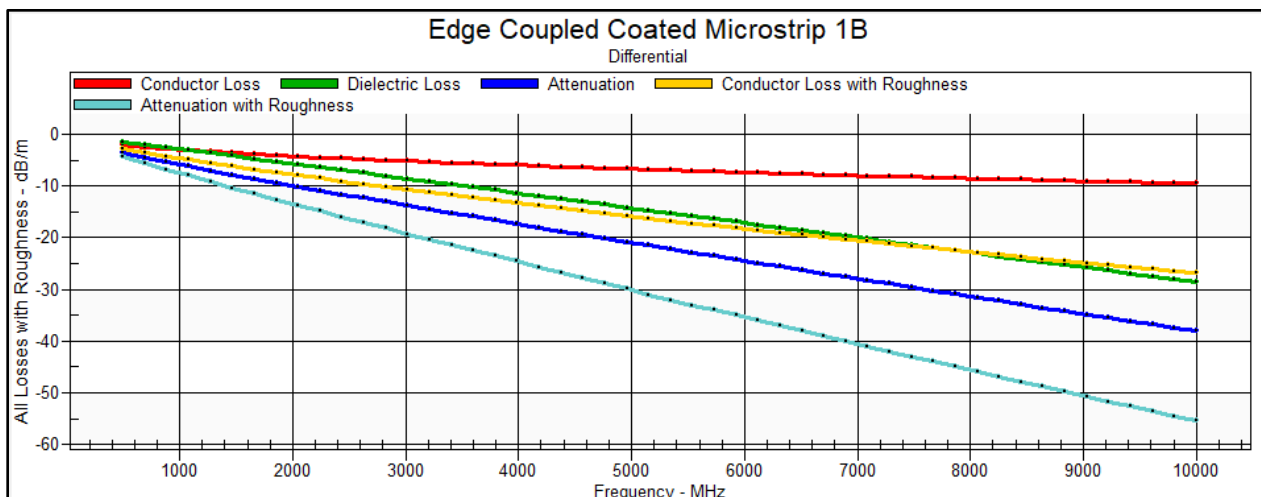

Speedstack charts a range of data series, including losses, impedance magnitude, inductance, resistance, capacitance and conductance; for differential structures select the transmission line mode, differential, odd or even mode.

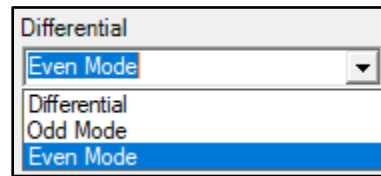

Click on the Display Series drop down to select the data to be charted.

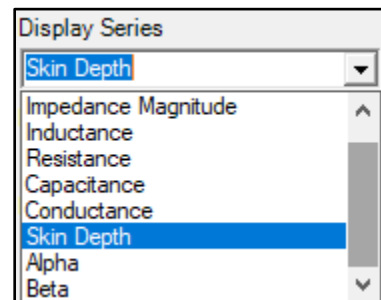

The chart below displays skin depth v frequency

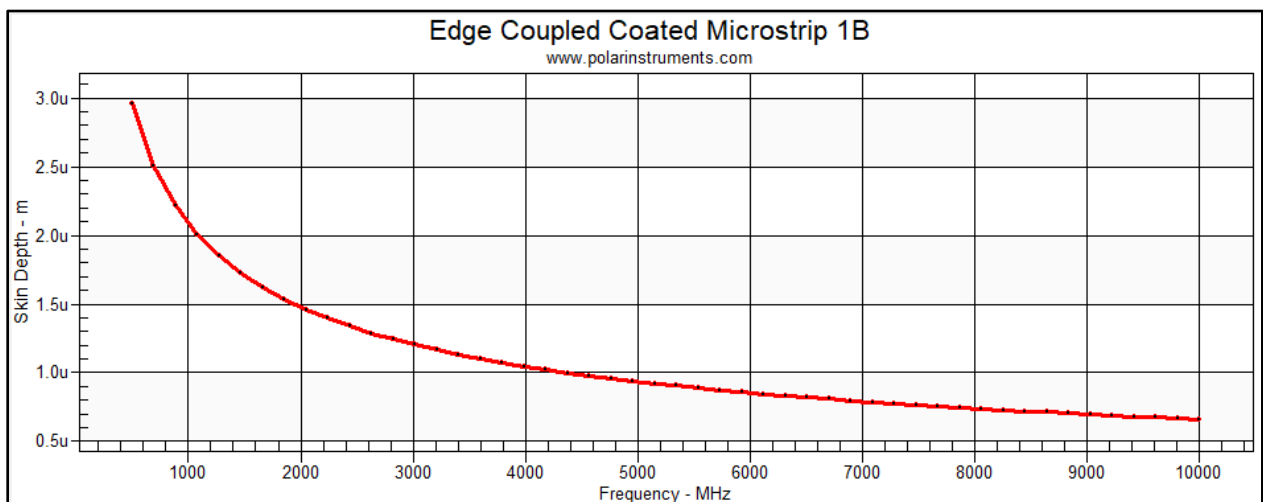

Printing the technical report

The Speedstack Si technical report includes the stackup with its stack data, the controlled impedance structures and structure data, the drill data and loss data for each structure in the stack.

Displayed loss data for each structure reflects the structure type, the frequency dependent parameters, the substrate causal extrapolation reference points, the surface roughness method and settings, frequency of interest and associated loss values for dielectric and conductor losses and total attenuation and losses with roughness.

Edge Coupled Coated Microstrip 1B



Length of Line: 25.4
Trace Conductivity: 5.9E+07 S/m
Frequency Minimum: 500 MHz
Frequency Maximum: 10 GHz
Frequency Steps: 20

Substrate Causal Extrapolation Reference Points

	Freq (Hz)	Ref Er	Ref TanD
H1	1.000E+09	4.2000	0.0195
H2			
H3			
H4			
REr			
CEr	1.000E+09	4.2000	0.0195

Surface Roughness Compensation: Huray

Ratio of Areas: 1
Effective Ball Radius: 0.75 µm
Number of Balls in Area: 32sq µm
Area of Ball Count: 90

Frequency of Interest: 1000 MHz
Conductor Loss: -3.003E+00 dB/m
Dielectric Loss: -2.840E+00 dB/m
Attenuation: -5.843E+00 dB/m
Conductor Loss with Roughness: -4.479E+00 dB/m
Attenuation with Roughness: -7.319E+00 dB/m

Click File|Print|Print Technical Report, Speedstack refreshes the loss data results and displays them in high quality graphical form.

Step through the pages to view the stack, impedance and drill data and the frequency dependent loss graphs for each structure in sequence in the stack.

Edge Coupled Coated Microstrip 1B



Length of Line: 101600
Trace Conductivity: 5.8E+07 S/m
Frequency Minimum: 500 MHz
Frequency Maximum: 10 GHz
Frequency Steps: 20

Substrate Causal Extrapolation Reference Points

	Freq (Hz)	Ref Er	Ref TanD
H1	1.000E+09	4.2000	0.0195
H2			
H3			
H4			
REr			
CEr	1.000E+09	4.2000	0.0195

Surface Roughness Compensation: Hammerstad

Surface 1 Roughness (RMS) R1: 5.08
Surface 2 Roughness (RMS) R2: 5.08

Frequency of Interest: 1000 MHz
Conductor Loss: -3.003E+00 dB/m
Dielectric Loss: -2.840E+00 dB/m
Attenuation: -5.843E+00 dB/m
Conductor Loss with Roughness: -5.778E+00 dB/m
Attenuation with Roughness: -8.615E+00 dB/m



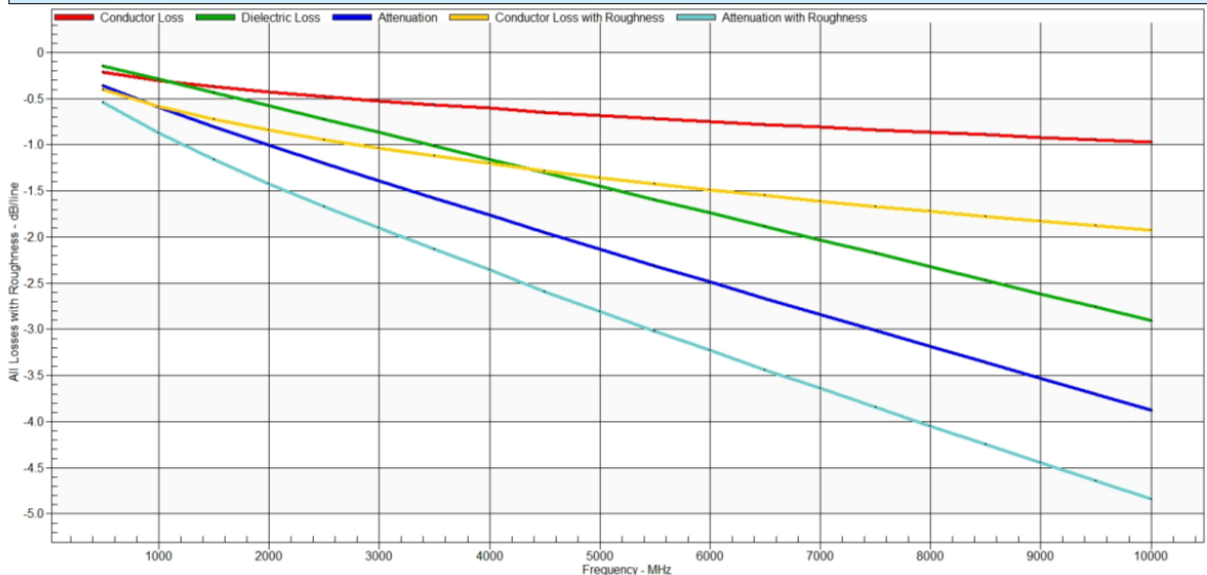

StackName:	Version:	Revision:	Modification:
Date:	Associated Documents:	Date of Revision:	Editor
Author:			
Department:			
Site:			



Speedstack Si to Si9000e data transfer

Speedstack and Si9000e incorporate the facility to realise bidirectional transfer of all structure parameters (i.e. both lossless and frequency dependent) for a single structure or all structures via the clipboard.

Parameter transfer is accomplished via the data transfer icons:

Single structures



To Field Solver

Use Speedstack's To Field Solver icon to transfer the parameters of a single structure via the clipboard from Speedstack to the Si9000e



From Field Solver

Use Speedstack's From Field Solver icon to transfer the parameters of a single structure via the clipboard from Si9000e to Speedstack



Paste Structure from Speedstack

Use the Si9000e's Paste Structure from Speedstack to paste the whole structure with all its parameters into the Si9000e – the currently displayed structure will be replaced



Copy Structure to Speedstack

With all calculations complete click the Copy Structure to Speedstack to return the structure to the stackup in Speedstack.

Multiple structures



To Si Project

Use Speedstack's To Si Project icon to transfer all structures as a project from Speedstack to the Si9000e



Paste from Speedstack into Si Project

Use the Si9000e's Paste from Speedstack into Si Project to paste the set of structures into the Si9000e as a project.

Sharing structure properties

Each structure in Speedstack can store a complete set of frequency dependent parameters, so each structure can have its own Length of Line, range of frequencies (FMin, FMax, FSteps and Frequency of interest) substrate data, surface roughness compensation and loss budget.

Using the data transfer icons within Speedstack allows a selected set of structure properties to be shared between other structures on the same electrical layer on the stackup.

To share parameters between structures, select the source structure (structure 1, Edge Coupled Coated Microstrip 1B.)

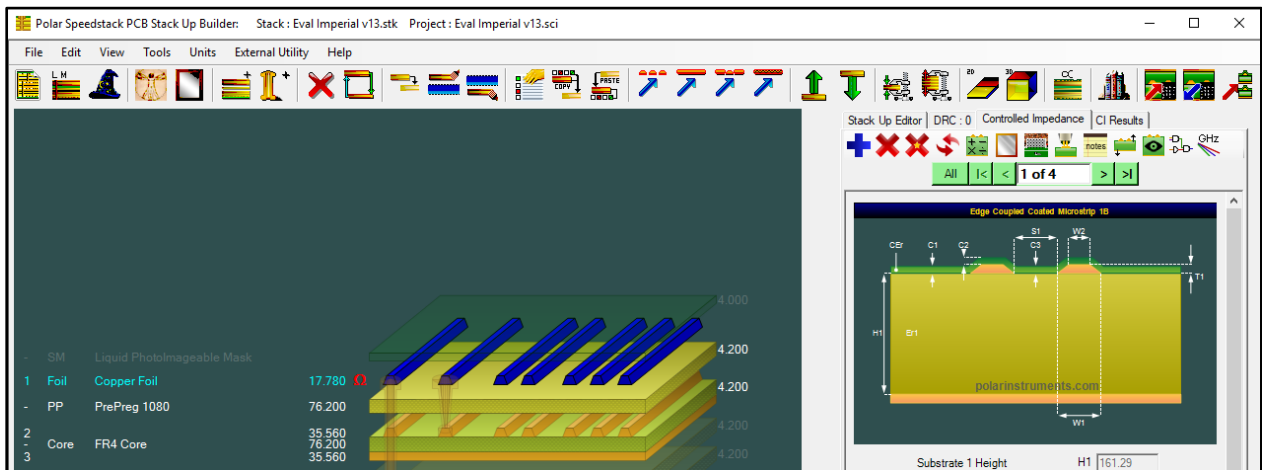

Frequency Dependent Properties

Select the Frequency Dependent Properties button to display the frequency dependent properties.

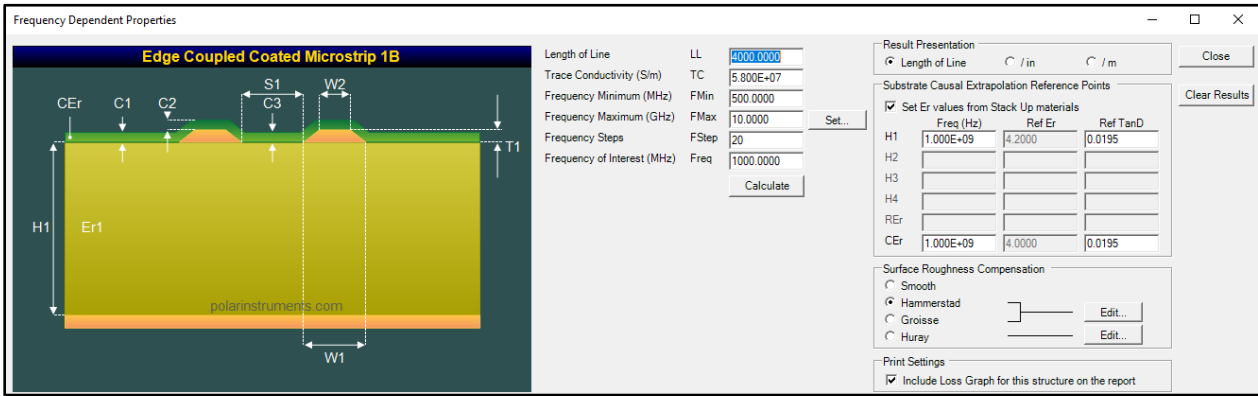

All the structure's properties, including all the frequency dependent parameters, will be available for sharing with the target structure.



To Field Solver

Close the dialog and click the To Field Solver button to copy the parameters to the clipboard.



From Field Solver

Select the target structure (in this example, structure 2, single ended Coated Microstrip 1B as shown below) and click the From Field Solver button.

All I< < 2 of 4 > >I

Substrate 1 Height	H1	161.29
Substrate 1 Dielectric	Er1	4.2000
Lower Trace Width	W1	114.30
Upper Trace Width	W2	88.90
Trace Thickness	T1	17.78
Coating Above Substrate	C1	25.40
Coating Above Trace	C2	25.40
Coating Dielectric	CEr	4.0000
Impedance		Zo
Target Impedance		75.00
Target Tolerance %		10.00

Speedstack displays the Paste Structure Properties dialog

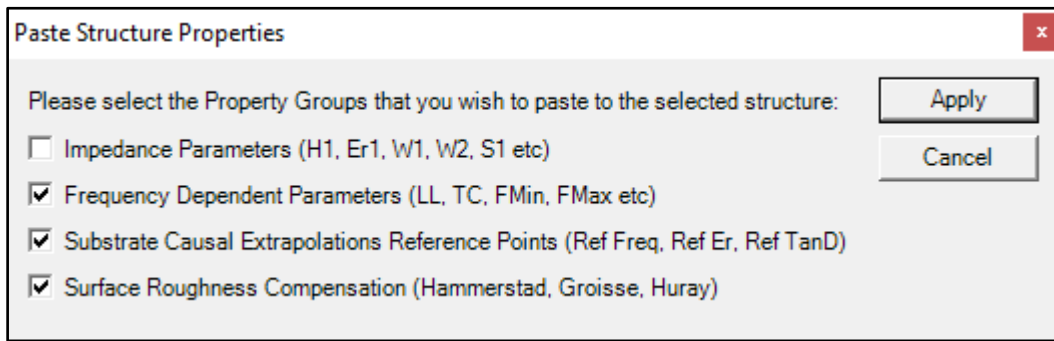

Select the properties to be pasted – in this case, the impedance parameters are unchecked as the source structure's 100 ohm differential impedance does not apply.

The frequency dependent parameters, along with the causal extrapolation reference points (frequency, Er and TanD) and surface roughness compensation method are applied to the target structure.

Transferring structures between Speedstack and Si9000e

Speedstack Si is fully integrated with the Si9000e transmission line field solver.

Users can transfer structures to the field solver for processing then transfer the solved properties back to Speedstack Si.

Transferring a single structure

Ensure the field solver is running. Select the structure to be copied to the Si9000e

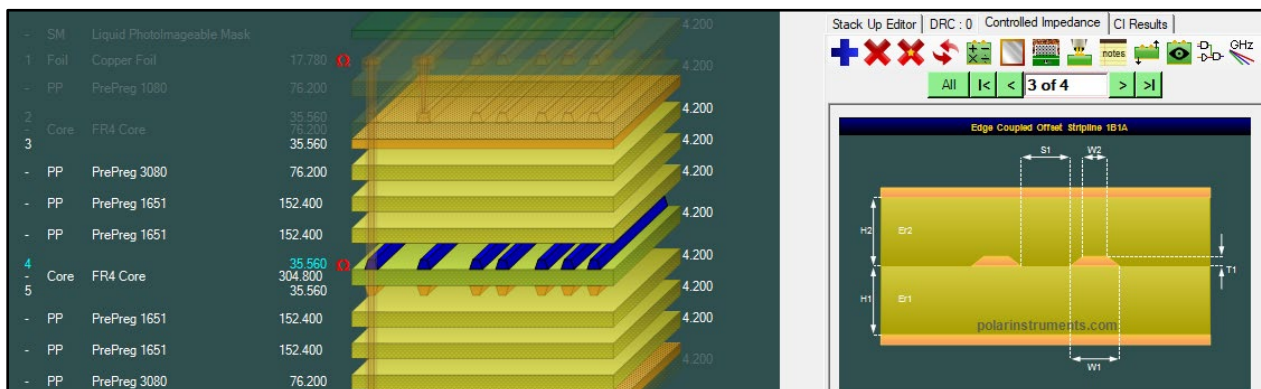

To Field Solver

Click the To Field Solver button to transfer the structure and all parameters to the Si9000e.

Switch to the Si9000e.



Paste Structure from Speedstack

Click the Si9000e's Paste Structure from Speedstack button to paste the structure complete with all impedance and frequency dependent parameters into the Si9000e.

The Si9000e displays the Paste Structure Properties dialog.

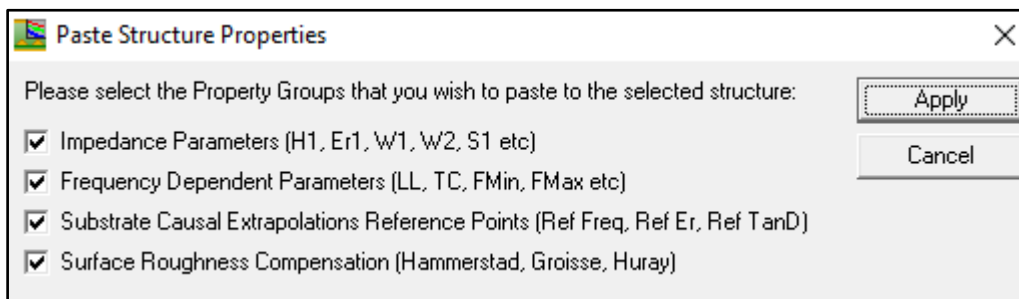

Choose which groups of properties are to be pasted into the field solver and click Apply. The impedance, lossless and frequency dependent properties are pasted into the field solver for processing. The units setting in Speedstack will replace the setting in Si9000e.

Solving for impedance

With the structure loaded into the Si9000e switch to the Lossless Calculation tab to display the structure graphic and lossless parameters.

			Tolerance	Minimum	Maximum	
Substrate 1 Height	H1	692.9100	± 0.0000	692.9100	692.9100	Calculate
Substrate 1 Dielectric	Er1	4.2000	± 0.0000	4.2000	4.2000	Calculate
Substrate 2 Height	H2	388.1100	± 0.0000	388.1100	388.1100	Calculate
Substrate 2 Dielectric	Er2	4.2000	± 0.0000	4.2000	4.2000	Calculate
Lower Trace Width	W1	191.9693	± 0.0000	191.9693	191.9693	Calculate
Upper Trace Width	W2	166.5693	± 0.0000	166.5693	166.5693	Calculate
Trace Separation	S1	215.9000	± 0.0000	215.9000	215.9000	Calculate
Trace Thickness	T1	35.5600	± 0.0000	35.5600	35.5600	Calculate
Differential Impedance	Zdiff	100.00		100.00	100.00	Calculate

Specify the target impedance then click the Calculate button for the parameter to be used in the goal seek (e.g. trace width); with the target impedance reached switch to the Frequency Dependent Calculation tab.

Running frequency dependent calculations

Enter the frequency dependent parameters, the extended substrate data settings, the surface roughness compensation method and values and click Calculate to refresh the results.

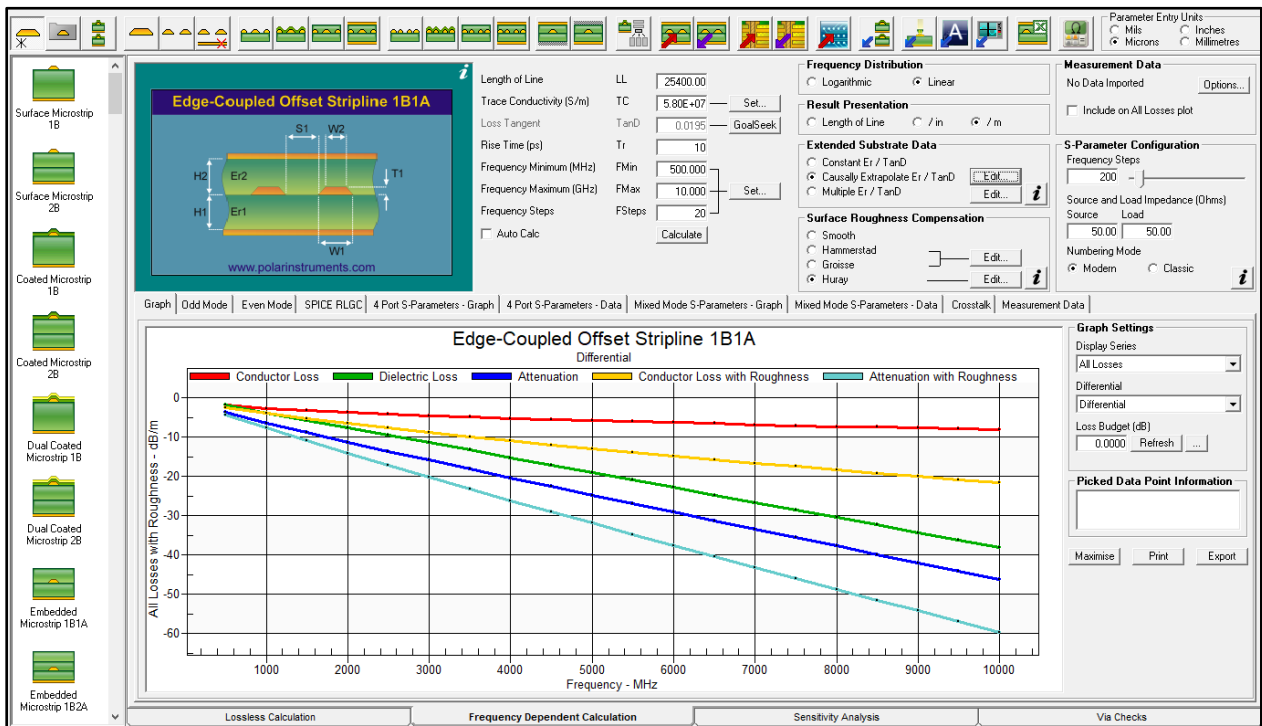

For detailed Si9000e operation see the Si9000e User Guide.



Copy Structure to Speedstack

With all calculations complete click the Copy Structure to Speedstack to return the structure to the stackup in Speedstack.

The Paste Structure Properties dialog is displayed.

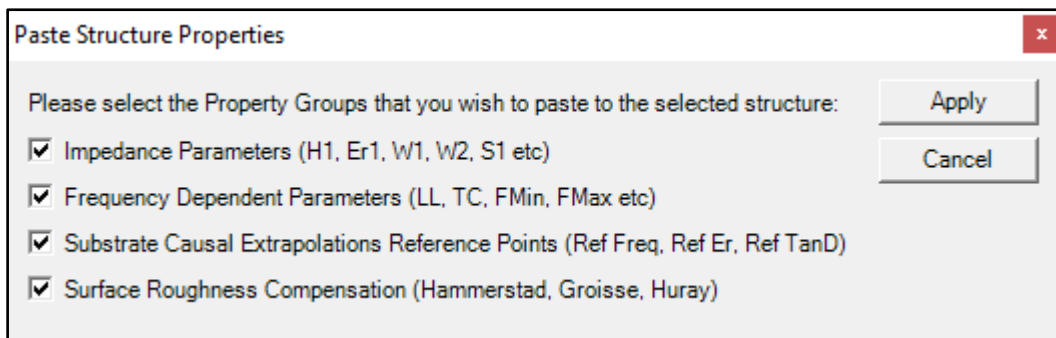

Choose which properties are to be updated and click Apply.

Rebuild and calculate the structure in Speedstack. The structure reflects the updated values.

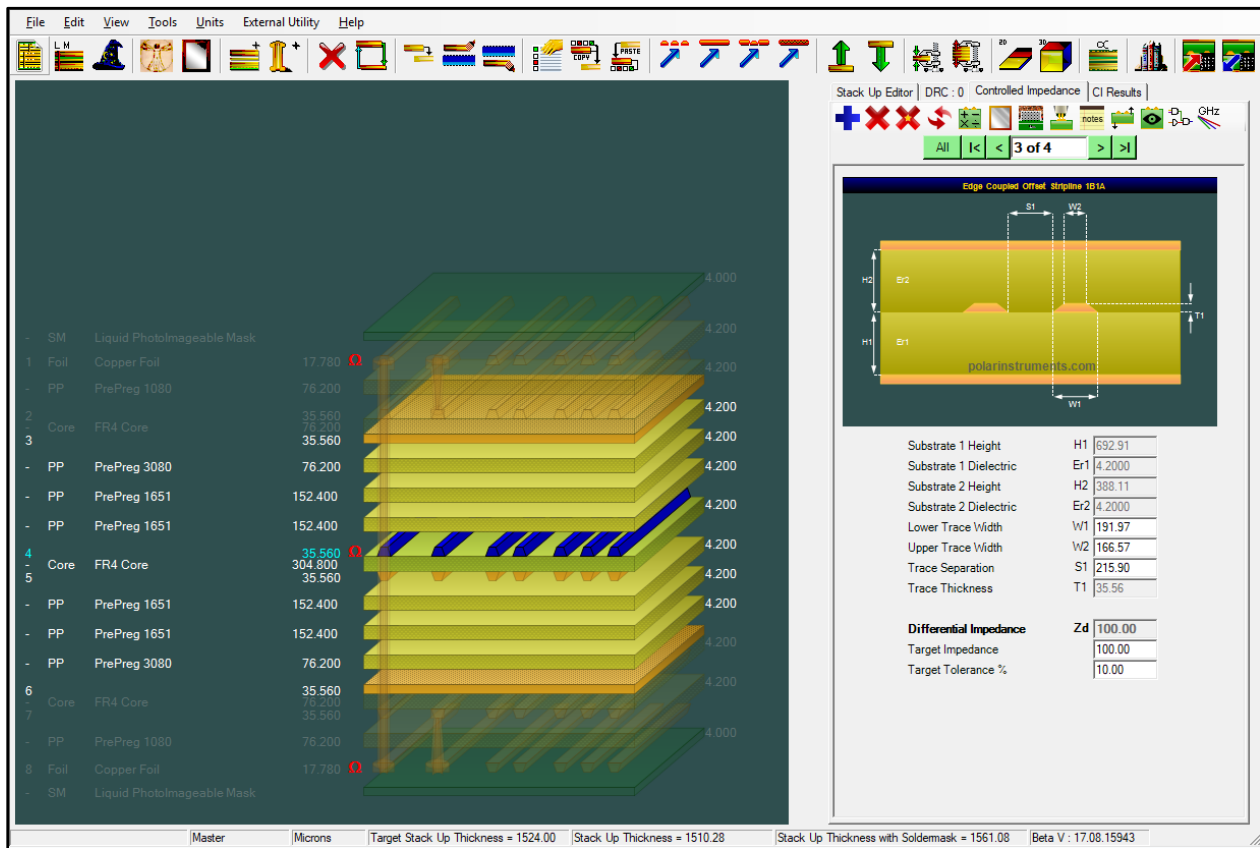

Transferring multiple structures via Si Projects

To transfer all the structures in a stack use the Si Projects transfer function incorporated in Speedstack Si and Si9000e.

Si Projects allows for transfer of all controlled impedance structures along with all lossless and frequency dependent parameters from Speedstack Si into the Si9000e field solver.

Si Projects allows groups of structures to be saved and recalled in Si9000e and the updated structures pasted back into Speedstack.

The stackup in the example below contains four structures.

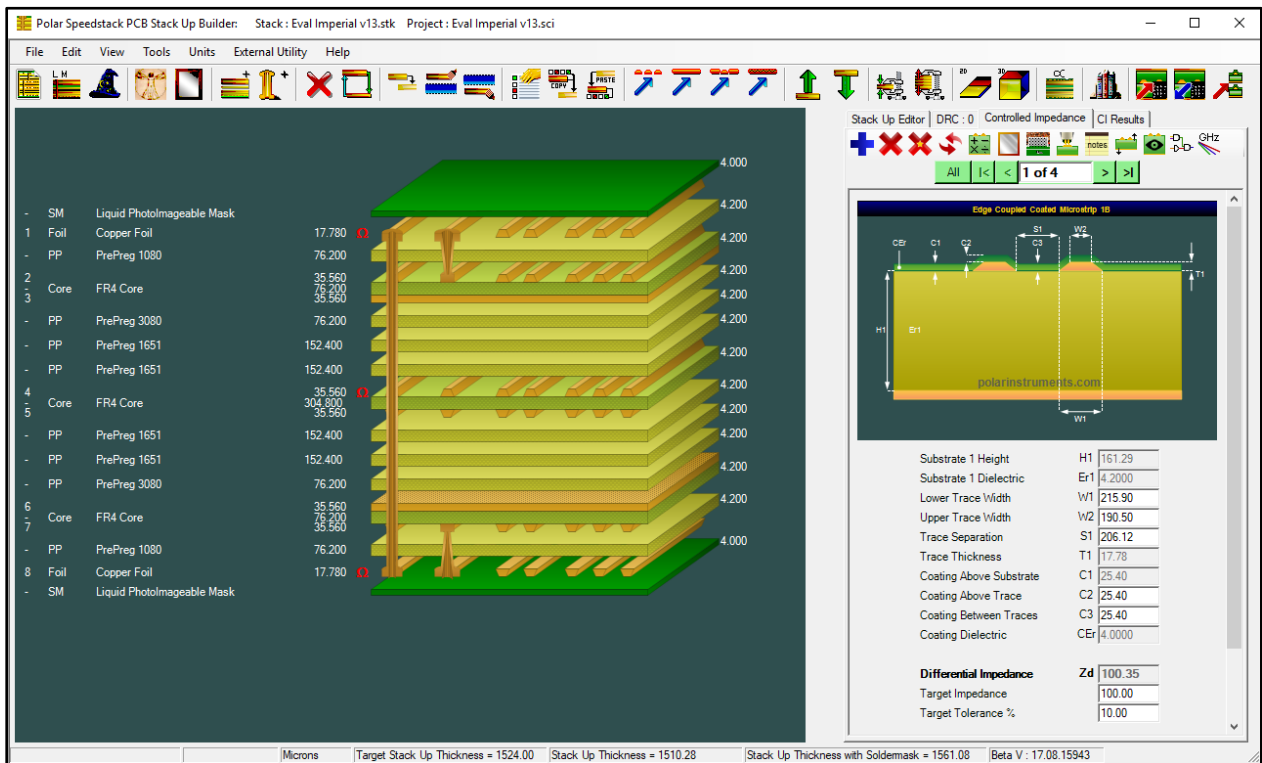

To Si Project

Use the To Si Project toolbar icon to copy the group of four structures from Speedstack Si and place them onto the clipboard; these structures can then be pasted directly into the Si9000e as a new project.



Paste from Speedstack into Si Project

Switch to the Si9000e and use the Si9000e's Paste from Speedstack into Si Project to paste the set of four structures into the Si9000e as a project.

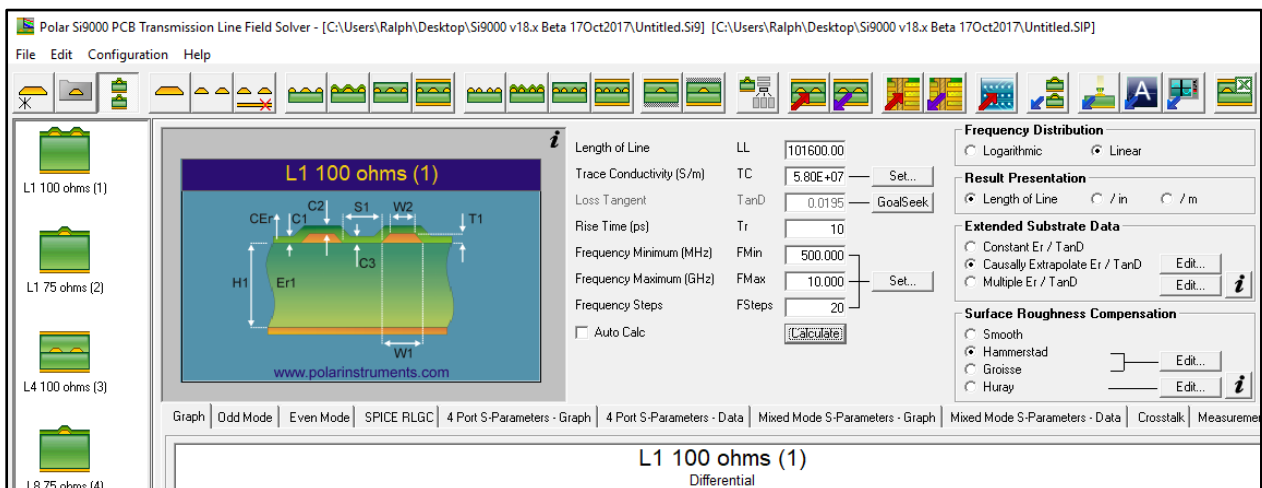

The Si9000e and Speedstack should automatically switch to the units that were in use when the structure was copied. (For instance, if Speedstack is in Mils and Si9000e is in Microns and a structure is copied from Speedstack to Si9000e the Si9000e should automatically switch to Mils.)

The complete set of structures appears in the field solver's Project window in the same order as shown in Speedstack.

The Si Project window lists the transferred structures in Speedstack's display order, showing the order number and impedance value along with a thumb nail graphic indicating the structure configuration.

Modifying structures

Selecting each structure displays its associated graphic in a grey background.

With a structure selected the structure parameters can be modified as required and all values recalculated. The recalculated structures can be pasted back into Speedstack.

To paste a structure back into Speedstack select the target structure in Speedstack, switch to the Si9000e, select the structure for transfer and use the transfer icons to update the selected structure in Speedstack.



*Rebuild and Recalculate
Displayed Structure*

Click the Rebuild and Recalculate Displayed Structure to refresh the displayed structure.



*Rebuild and Recalculate
All Structures*

Click the Rebuild and Recalculate All Structures to update all structures in the stack

Creating CITS test files

Speedstack can create CITS test file data for each controlled impedance structure in the stack.



Set CITS Test

Select each structure and click Set CITS Test to display the Edit Test data dialog; specify the CITS test parameters for each structure to be tested and click OK.

Edit Test data

<p>Structure Details</p> <p>Structure Description: <input type="text" value="Offset Coplanar Strips 1B1A"/></p> <p>Impedance: <input type="text" value="50.00"/></p> <p>Signal Layer: <input type="text" value="4"/></p>	<p>Channel Select</p> <p><input checked="" type="radio"/> Single Ended Probe ID: <input type="text" value="Chan 1"/></p> <p><input type="radio"/> Differential</p>
<p>Horizontal</p> <p>Units: <input type="text" value="Inches"/></p> <p>Test From: <input type="text" value="3"/></p> <p>Test To: <input type="text" value="7"/></p> <p>Test Method: <input type="text" value="Absolute"/></p> <p>Vp:</p> <p><input checked="" type="radio"/> Default</p> <p><input type="radio"/> User</p>	<p>Vertical</p> <p>Ohms/Division: <input type="text" value="10"/></p> <p>Tolerance</p> <p><input checked="" type="checkbox"/> Locked</p> <p>Plus: <input type="text" value="10"/> %</p> <p>Minus: <input type="text" value="10"/> %</p>

Exporting the CITS test file

With the test data specified for each structure, from the File menu choose Export To|Export CITS File. Add descriptive Board Details and notes as required.

Board Details

Customer	<input type="text" value="Polar"/>
Board Type	<input type="text" value="G308 back plane"/>
Part Number	<input type="text" value="1234"/>
Revision Number	<input type="text" value="Rev 06"/>

Click Make File and navigate to a suitable folder and save the CITS (.cif) test file.

Working with flex-rigid stackups

Speedstack Flex

Speedstack Flex allows PCB fabricators and OEM engineers rapidly to create and document accurate and efficient flex-rigid PCB layer stackups.

The graphical stackup display

The Speedstack Flex Navigator enables the board designer to link and document as many cross sections as necessary in order to fully document a flex-rigid build up.

Speedstack Flex supports documentation of common flex-rigid constructions, including *doublets* where stacked pairs of flex link two rigid sections of the flex-rigid construction together (see graphic below.)

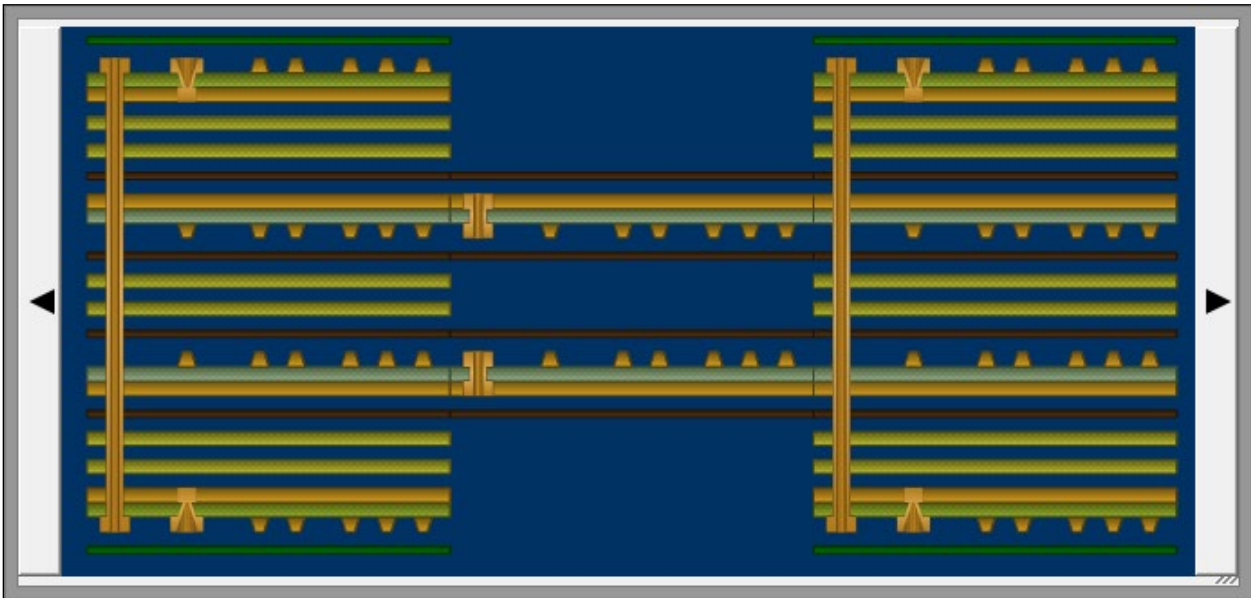

Flex-rigid stacks

Speedstack constructs a flex-rigid stack from an existing stack to which will be added a series of sub-stacks. This stack is referenced by Speedstack as the *master stack*. The electrical layer numbers of sub-stacks are determined from the master stack, so this stack should be created first.

The master stack is effectively a "bill of materials" stack and contains all the materials used in all sub-stacks; i.e., the *master stack* contains the full set of materials used in the final stackup and documents each rigid and flex-rigid section with as many "sub-stacks" as needed for the design. There

are no limits to the number of sub-stacks or layer count of the total build.

Creating sub-stacks

Sub-stacks may be created either by:

- duplicating the master stack and then enabling/disabling materials in the resultant sub-stack to achieve the desired stackup or
- defined by selecting a range of layers from the master stack to form the new sub-stack.

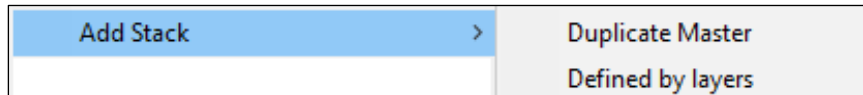

A range of materials including flexible adhesives, bondply and FlexiCore can be enabled or disabled for each layer, and impedance structures can be added to each sub-stack.

Mesh / Crosshatch ground planes

When used with Polar's Si8000m and Si9000e field solvers, Speedstack Flex permits modelling and documenting mesh/crosshatch ground planes from within the Speedstack Flex environment. Mesh geometry and structure data can be easily shared between Si8000m and Si9000e.

Internal Coverlays

Advanced rules allow impedance structures to be added when coverlays exist internally within a stack. When a coverlay is beyond the outer copper it will behave like a coating, when internal it will behave like a bondply or prepreg.

Definable colours per material

Speedstack Flex can set and store individual material colours via the material Properties dialog. This will help ensure that special build requirements are obvious during fabrication. This will be found useful for documenting plated layers or highlighting specific material usage such as no-flow prepreps and flexible cores.

Enabling Speedstack Flex/HDI

To enable Speedstack Flex/HDI select Tools|Options and ensure the Licensing pane purchasable option Speedstack Flex/HDI License check box is ticked.

Adding a flexible core

Create and save a symmetrical 6-layer stackup as shown in the sample stack below

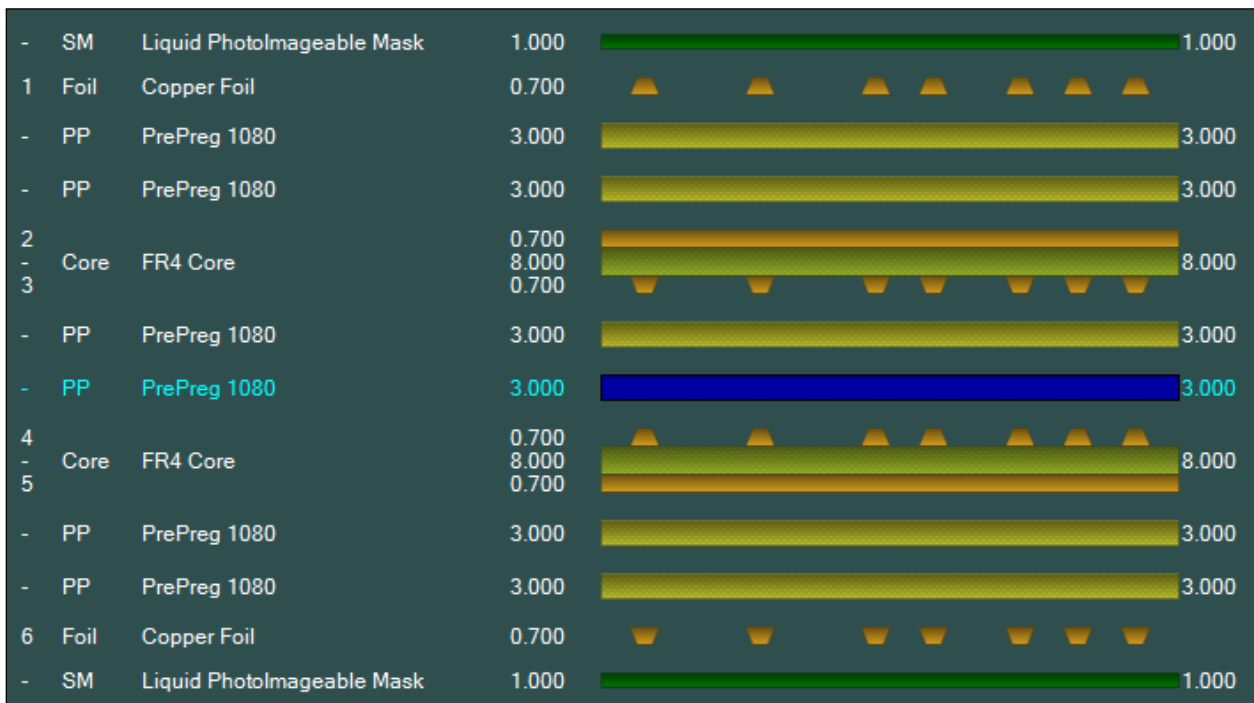

This stack is referenced by Speedstack as the *master stack* discussed earlier; this section describes adding a series of sub-stacks to create the complete flex-rigid stack.

Ensure Symmetrical mode is off, right click the prepreg above Layer 4 copper and add a flexible core:

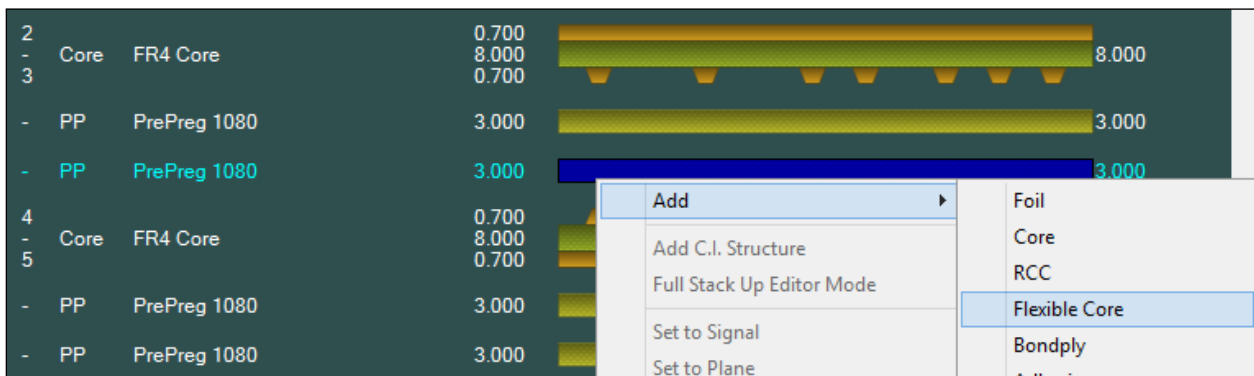

The flexible core is added as the new layers 4 and 5.

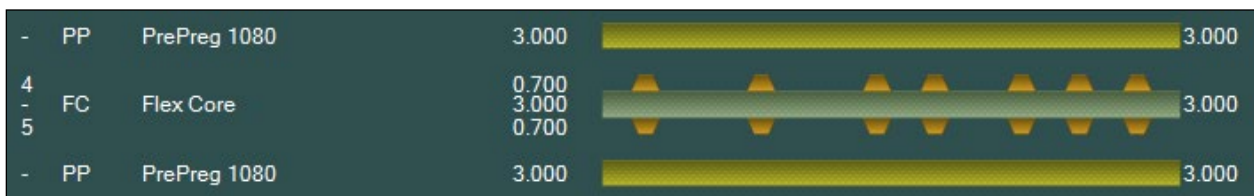

Using the Navigator

Press F4 to display the Navigator

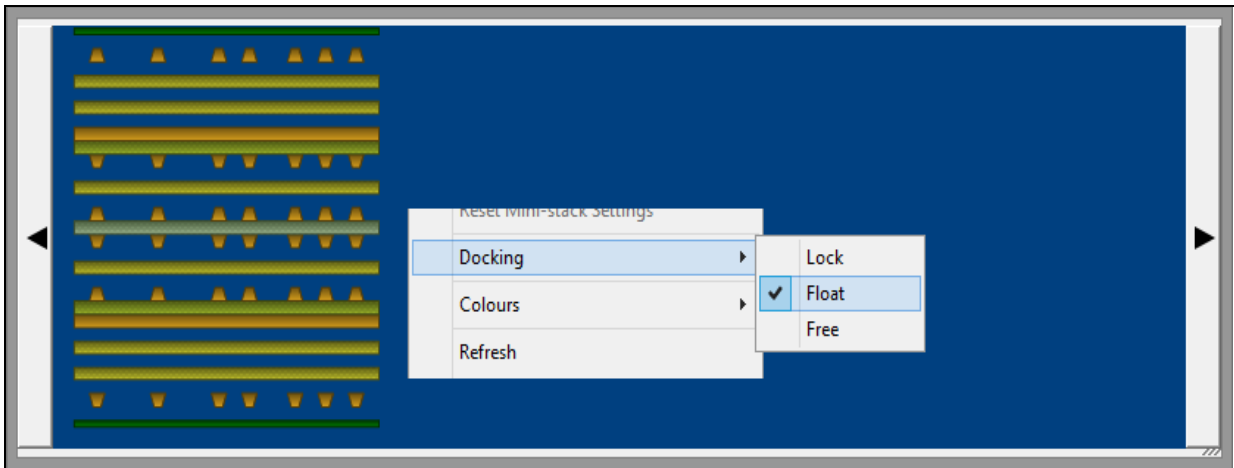

Right click the Navigator and choose Docking|Float to allow the Navigator window to be resized. The Navigator will move with Speedstack's Stack Editor. Choose Free to allow the Navigator to move independently of the Stack Editor.

Adding stacks

Adding stacks, for example, to form a flex-rigid structure or to illustrate the press cycles of an HDI build, can be achieved by:

- duplicating the master stack and disabling materials selectively
- defining the layers of the new stack

Defining new stacks defined by layers

New stacks may be added, defined by layers of the master stack. Choose Add Stack|Defined by Layers:

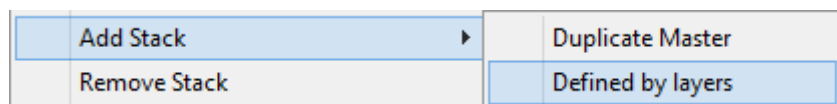

It will be necessary to choose layers in the master stack to be the top and bottom layers of the new sub-stack and to position the new stack relative to the original stack.

Use the drop-down controls to select the top and bottom layers and position the new stack.

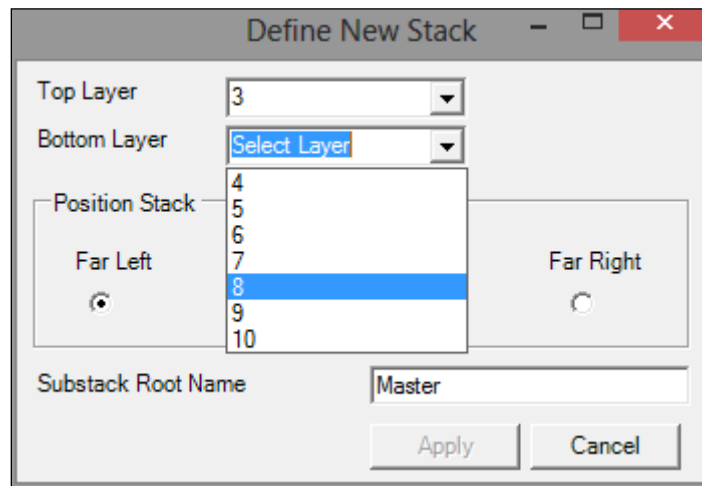

The starting and finishing layers (derived from the master stack) form the top and bottom layers of the sub-stack; the new stack is positioned relative to the current stack, choose a descriptive sub-stack root name and click Apply.

Adding a flex stack Defined by layers

Select the stack in the Navigator window and click Add Stack and choose Defined by Layers

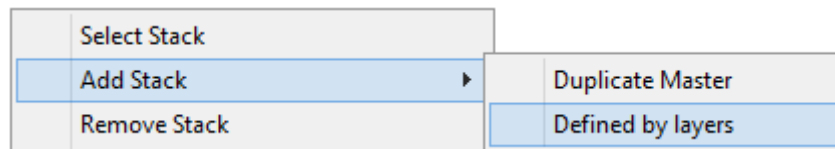

From the drop-down list choose Layer 4 as the Top Layer and Layer 5 as the Bottom Layer as shown below and enter Flex as the Substack Root Name.

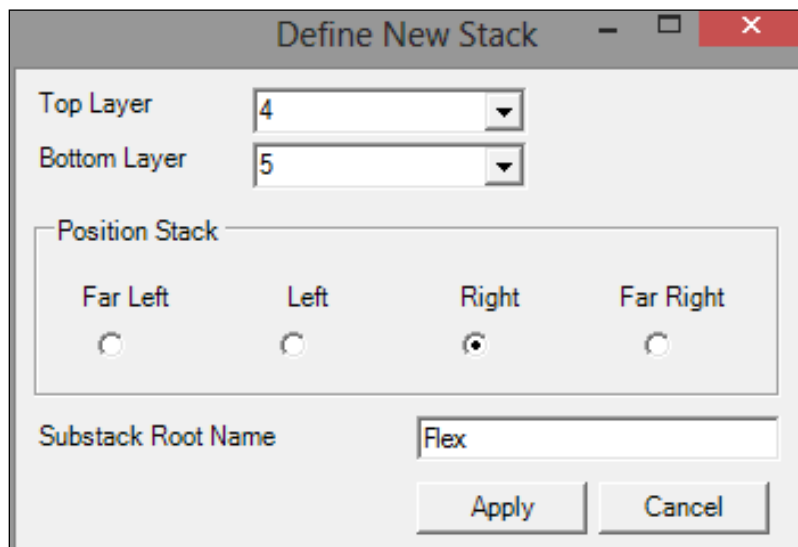

The new stack reflecting the top and bottom chosen layers is added to the Navigator in the specified position (to the right in the example below.)

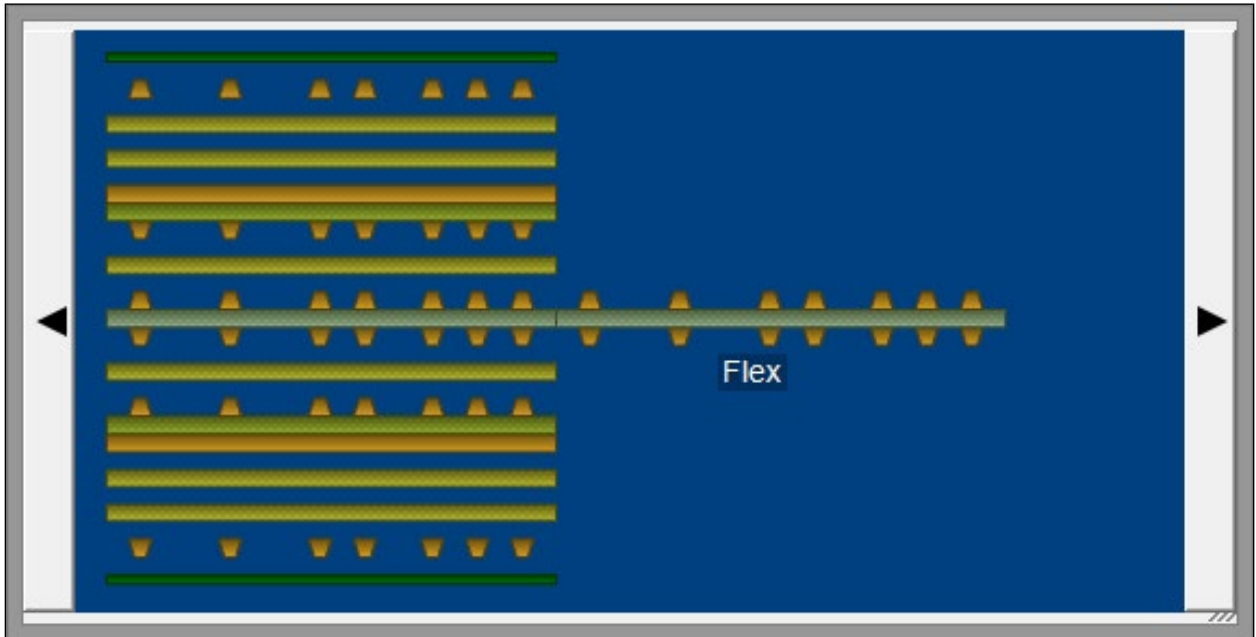

Each sub-stack can be renamed individually as required.



Click the new stack – the selected stack is reflected in the Stack Editor and listed in the status bar.

Adding materials to the sub-stack

Select Symmetrical mode, in the Stack Editor click the new core and add a coverlay above.

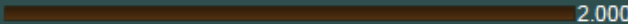
-	CLay	Coverlay	2.000		2.000
4	FC	Flex Core	0.700 3.000 0.700		3.000
-	CLay	Coverlay	2.000		2.000

The coverlays are added symmetrically about the core. Changes made in the Stack Editor are reflected in the Navigator. Click into the Navigator – use the mouse wheel to resize.



See 3D View

The Navigator can display in 2D or 3D views. Click on the See 3D View button to display a 3 dimensional view of the stackup

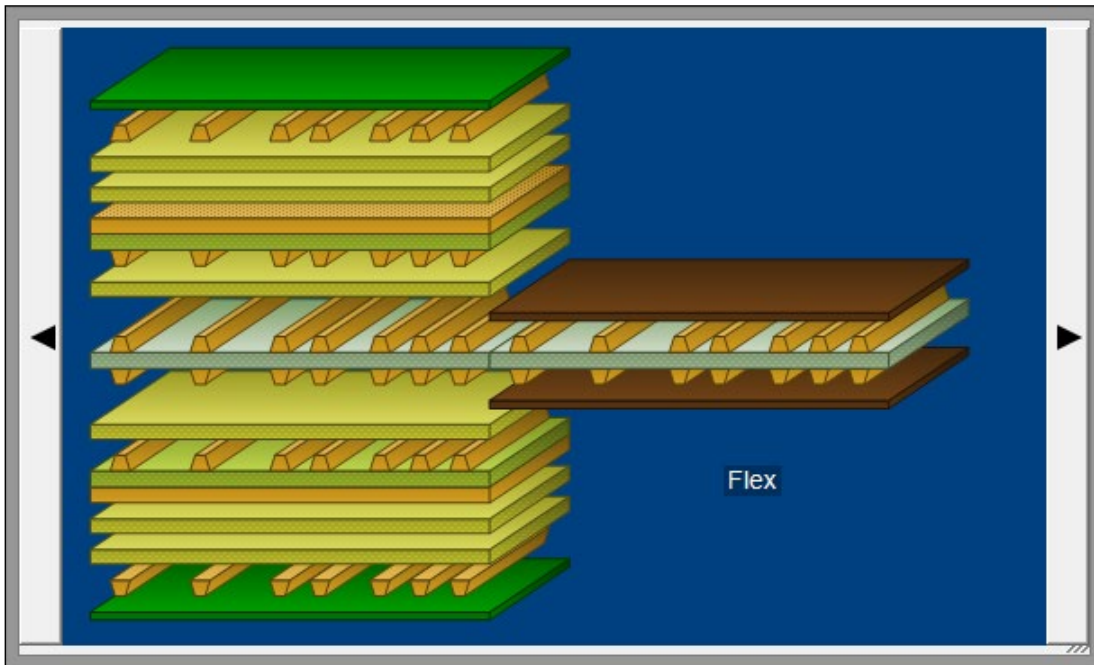

The new stack with its added materials appears in the Navigator; clicking each stack in the Navigator displays it in the Stack Editor and allows editing as described earlier to add controlled impedance structures, change layer types, add non-copper layers, etc.

Adding a new stack by duplicating the master stack

The master stack is effectively a "bill of materials" stack and contains all the materials used in all sub-stacks.

Master stack

The *master stack* contains the full set of materials used in the final stackup and documents each rigid and flex-rigid section with as many "sub-stacks" as needed for the design.

There are no limits to the number of sub-stacks or layer count of the total build.

To add a sub-stack:

- Right click the Navigator

- Choose Add Stack|Duplicate Master

- Rename the new stack and click OK.

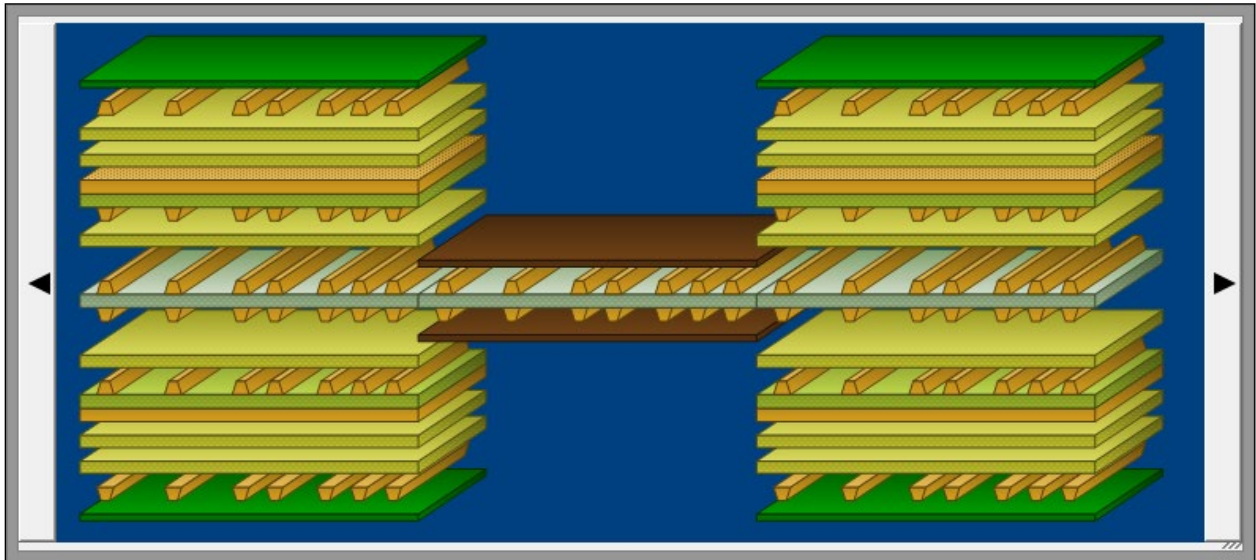

The new stack is added to the Navigator. Click on each stack to display it in the Stack Editor and then edit as required.

Enabling/disabling materials in the sub-stack

Utilize the Stackup Editor to add drills and to selectively enable or disable materials in sub-stacks. Note that materials cannot be enabled or disabled in the master stack – the Flex-Rigid command is greyed out if the master stack is selected



Symmetrical Mode

Symmetrical Mode: If Symmetrical Mode has been selected, material will be disabled both at the top and bottom of the sub-stack.

With the sub-stack selected in the Stackup Editor, right click the sub-stack, select the materials to be disabled – choose Flex-Rigid and then choose Disable Material.

Flexi-Rigid >	Enable Material
	Disable Material
	Toggle Material Selection

Disabled materials are shown in blue and will be removed from the sub-stack display (for example to illustrate a press cycle; the Navigator will display the press cycle with the materials removed alongside the master stack.)

See also *Working with HDI builds – Enabling/disabling materials in the sub-stack*

Copying and pasting stacks

To copy a stack in the Navigator select the stack, choose Copy and Paste Stack, then from the dialog below choose the position of the new stack

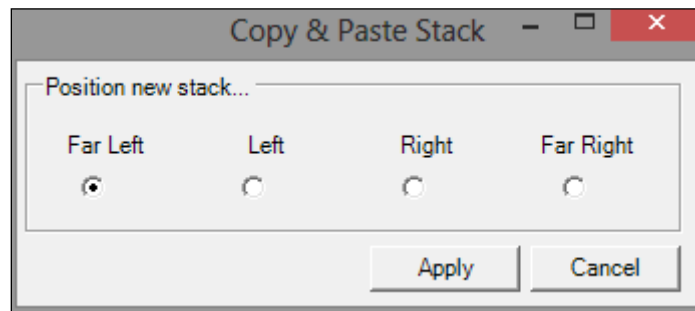

Removing stacks

To remove a stack right click the Navigator, choose Remove Stack and select the stack to be removed.

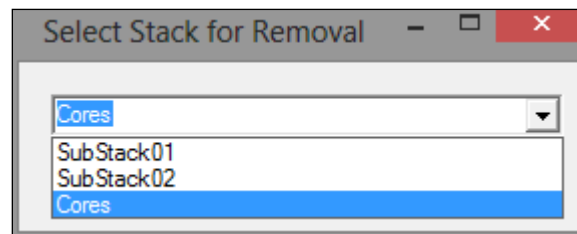

Using mini-stacks in rigid-flex constructions

The Speedstack Flex Navigator enables the board designer to link and document as many cross sections as necessary in order to fully document a flex-rigid build up. Speedstack Flex supports documentation of common flex-rigid constructions, including *doublets* where stacked pairs of flex link two rigid sections of the flex-rigid construction together (see the graphic below.)

The stack construction below is typical of a bookbinder flex, in which a stacked pair of flex sections link the two rigid sections of the flex-rigid construction.

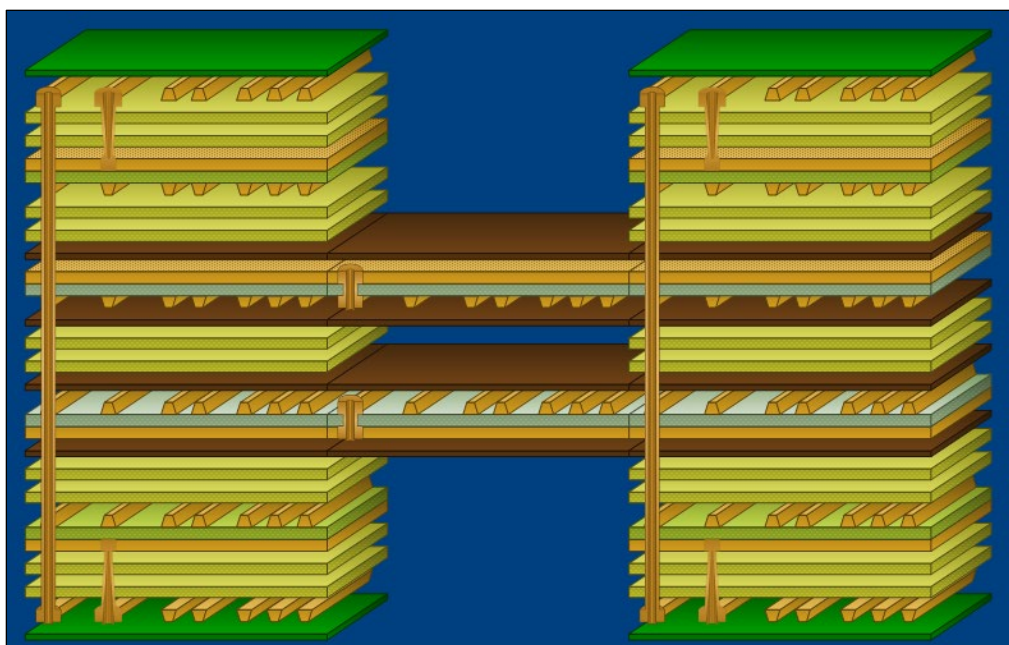

When adding the first impedance structure to the flex sub-stack Speedstack allows the flex sub-stack to be specified as:

- a single stack construction with two flex cross-sections separated by an air gap
- two *mini-stacks*

In many cases it would be appropriate to treat the individual stacks as *mini-stacks* from an impedance viewpoint but where the flex cross-sections would interact with each other the sub-stack can be defined as a single stackup with air between the flex sections as a dielectric.

Adding controlled impedance structures

When a controlled impedance structure is added to a signal layer, Speedstack displays the Structure Control dialog to allow the designer to choose a structure based on the arrangement of signal layers and reference planes.

Click on the sub-stack to display it in Speedstack's Stackup Editor.

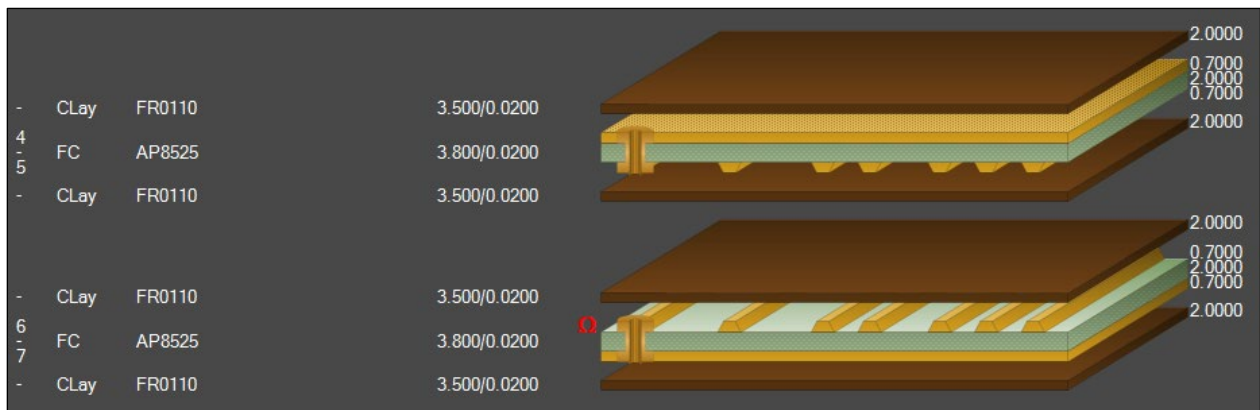

The flex sub-stack above can be regarded as a single stack with an air gap between two flexible layers or as two separate stacks (*ministacks*)

If a controlled impedance structure is added (in this case to signal layer 6 in the sub-stack above) the flex sub-stack above must be defined either as a single stack with an air gap or two separate "ministacks".

When the first structure is added Speedstack displays the Select Ministack Handling Method dialog

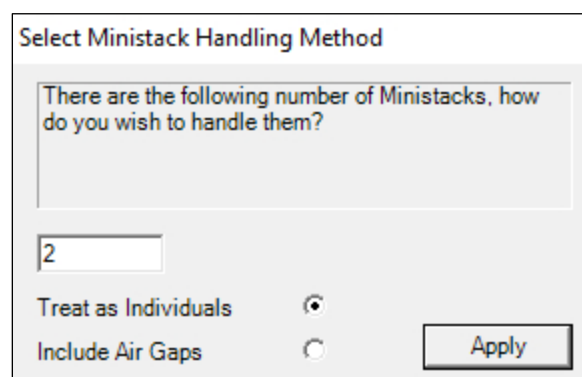

The mini-stack handling method chosen will determine the structures available for the selected layer. The structure options are shown in the dialogs below.

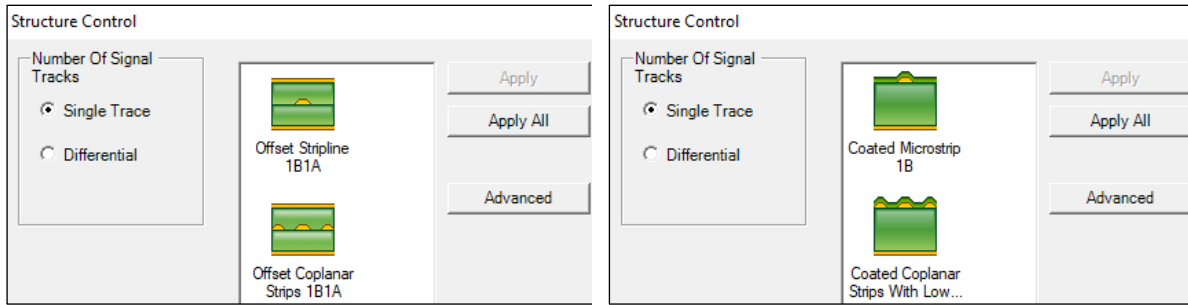

Defining the sub-stack as a single stack with air gap

Defining the sub-stack as two ministacks

Sub-stack impedance structure options

For the sub-stack above specified as a single stack with an airgap, structures on layer 6 will effectively be offset striplines or offset coplanar strips.

If the sub-stack is defined as two mini-stacks, impedance structures will function as coated microstrips or coated coplanar strips.

Resetting mini-stack settings

The current mini-stack settings for the flex sub-stack may be reset from a single stack to two mini-stacks and vice versa.

Note: – resetting the stack handling method clears the structures on the sub-stack.

Select the flex sub-stack in the Speedstack Navigator (shown highlighted below.)

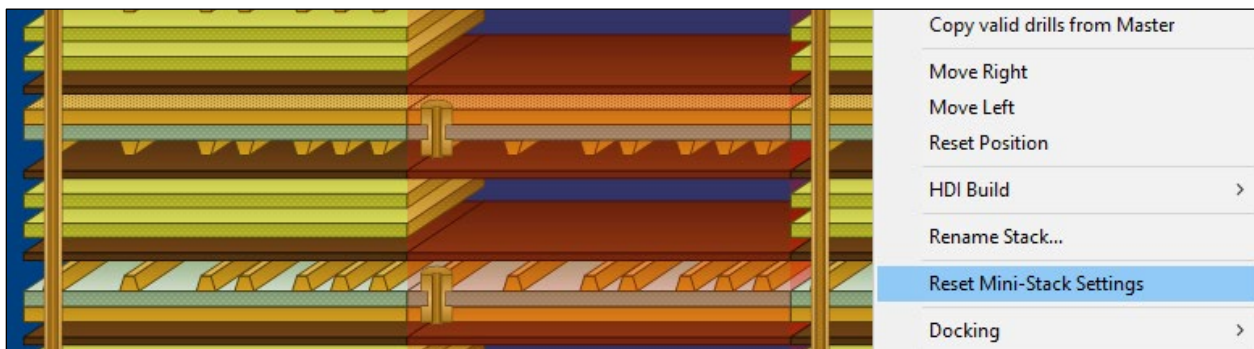

Right click the sub-stack in the Speedstack Navigator and choose Reset Mini-Stack Settings – the controlled impedance structures added to the sub-stack will be cleared from the sub-stack.

When a structure is next added to the sub-stack Speedstack displays the Select Ministack Handling Method.

Right click the sub-stack in the Speedstack Navigator and choose Reset Mini-Stack Settings – the controlled impedance structures added to the sub-stack will be cleared from the sub-stack.

When a structure is next added to the sub-stack Speedstack displays the Select Ministack Handling Method.

As described earlier, redefine the sub-stack as a single stack with airgaps or two separate stacks. Any new structures added to the sub-stack will reflect the chosen mini-stack handling method.

Aligning materials in the Navigator

On occasions, adding a flexible stack results in misalignment between layer materials displayed in the Navigator, for example, between the bondply and coverlay layers and the associated prepreg layers – see the graphic below.

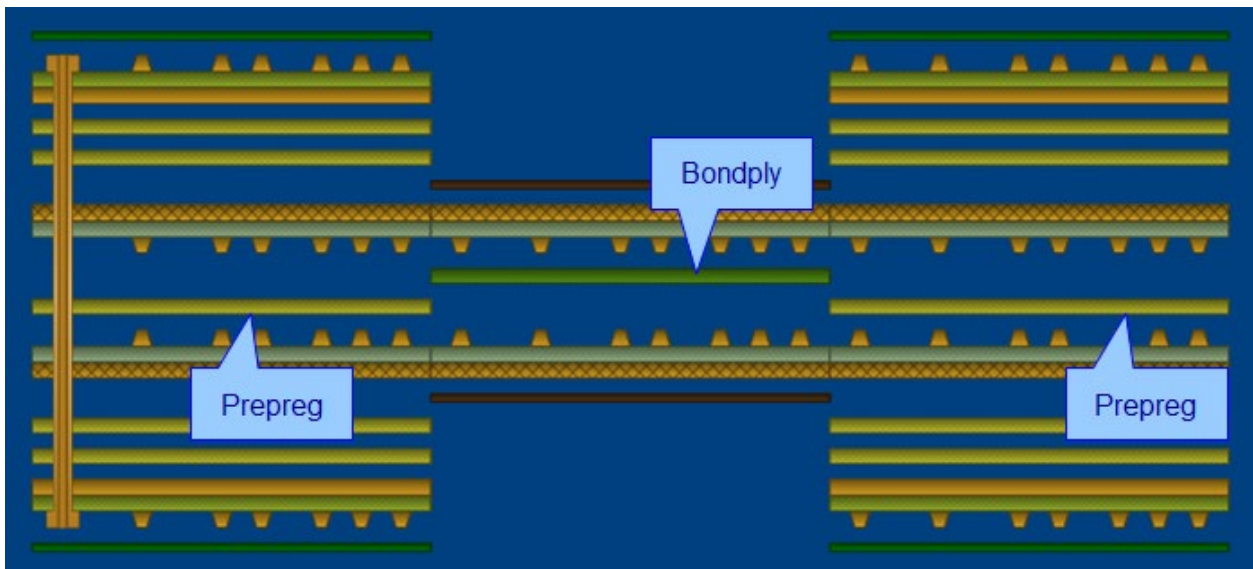

To move the layers into alignment, select the stack in the Stack Editor and use the FlexNav Move Up and FlexNav Move Down commands from the Edit menu.

In the example above select the flexible stack in the Stack Editor, select the upper Coverlay layer and shift the layer up into alignment with the prepreg layer in the rigid stack (use the Ctrl + Shift + Up arrow keys)

Repeat the alignment for the bondply and lower coverlay materials (using the Ctrl + Shift + Down arrow keys.) The materials are displayed aligned in the Navigator – below.

To return the stack to its original alignments, from the Edit menu Reset All NVDP (Navigator Visual Display Position) Attributes.

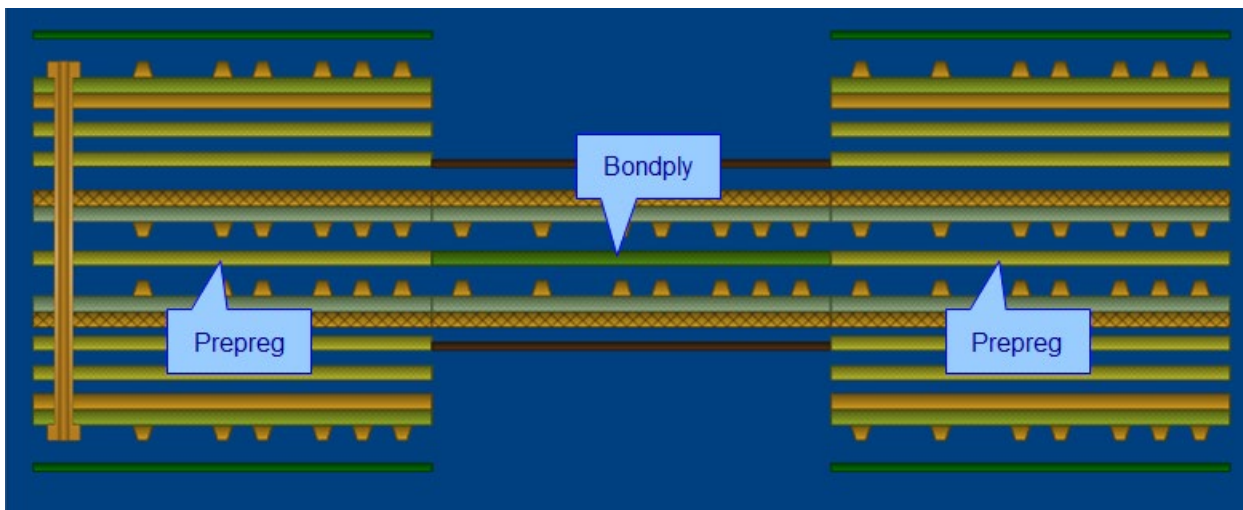

The Navigator display is reproduced in the Technical Report

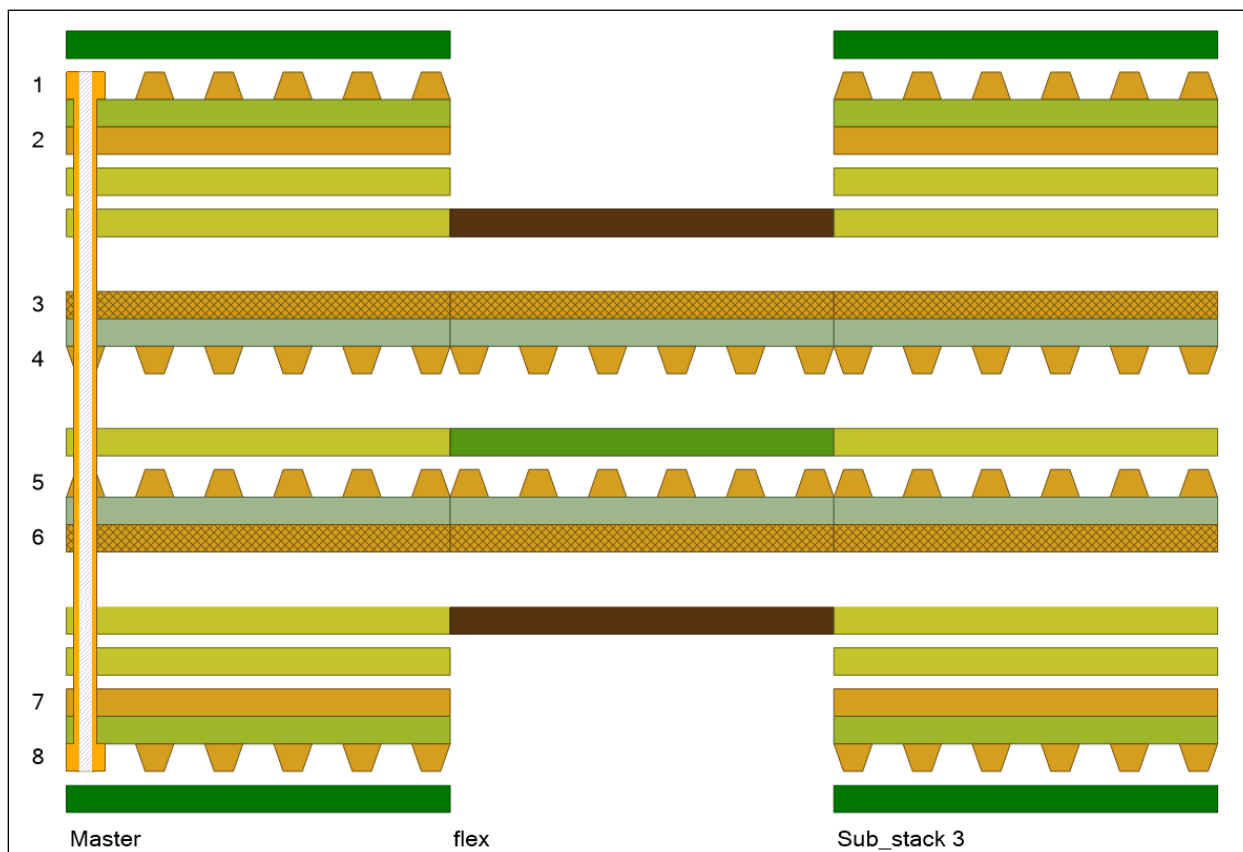

The technical report also supports different materials on the same dielectric layer, improving the clarity of documentation between the stackup designer and fabricator.

Displaying the stack in Proportional View

Speedstack can display the stackup so that the material thicknesses are shown proportional to each other. Select the

stack in the Stackup Editor and from the View menu choose Proportional Stack Viewer.

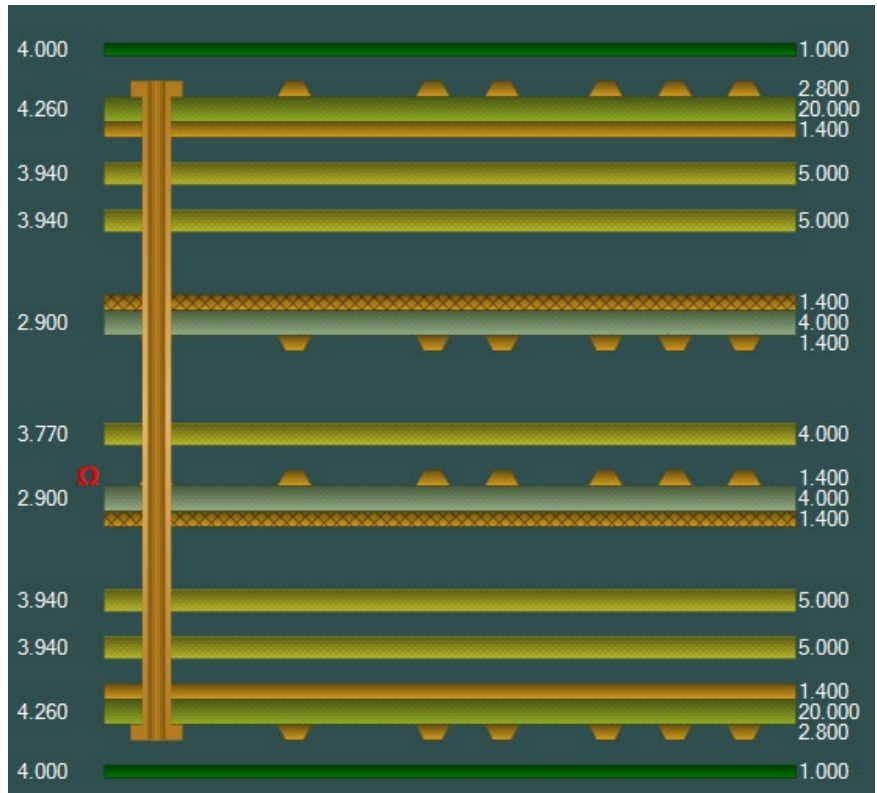

This visual aid will be found useful when considering the dielectric thicknesses between electrical layers.

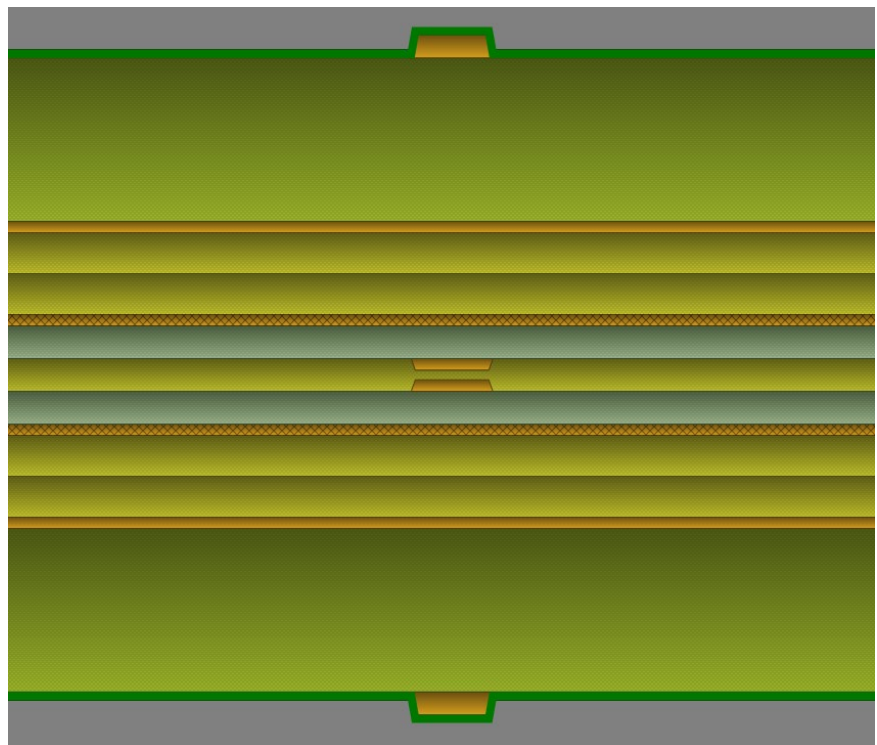

Using the Ruler within Proportional view
 Select the stack in the Stackup Editor

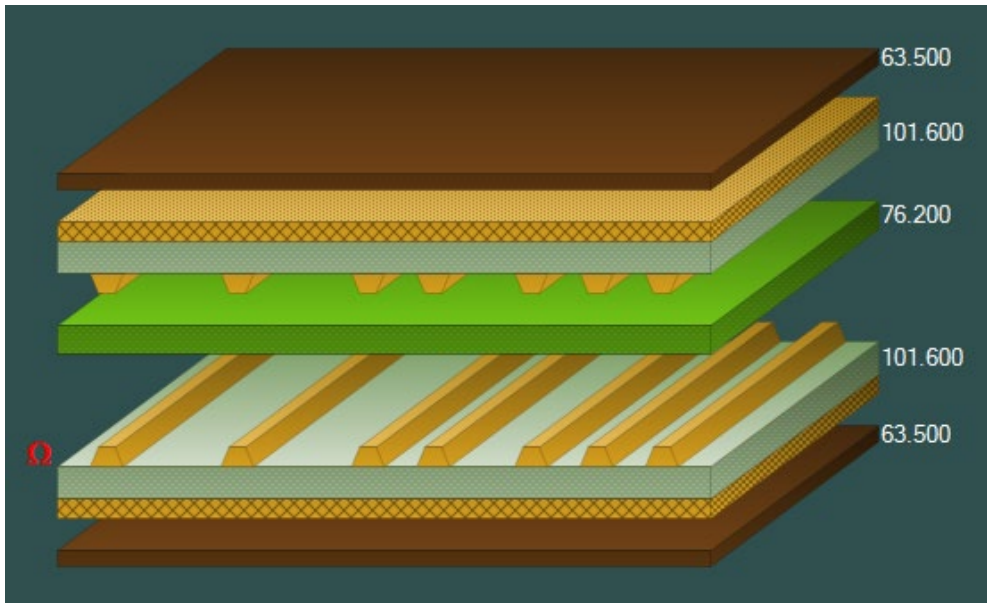

Switch to Proportional View and click the ruler on.

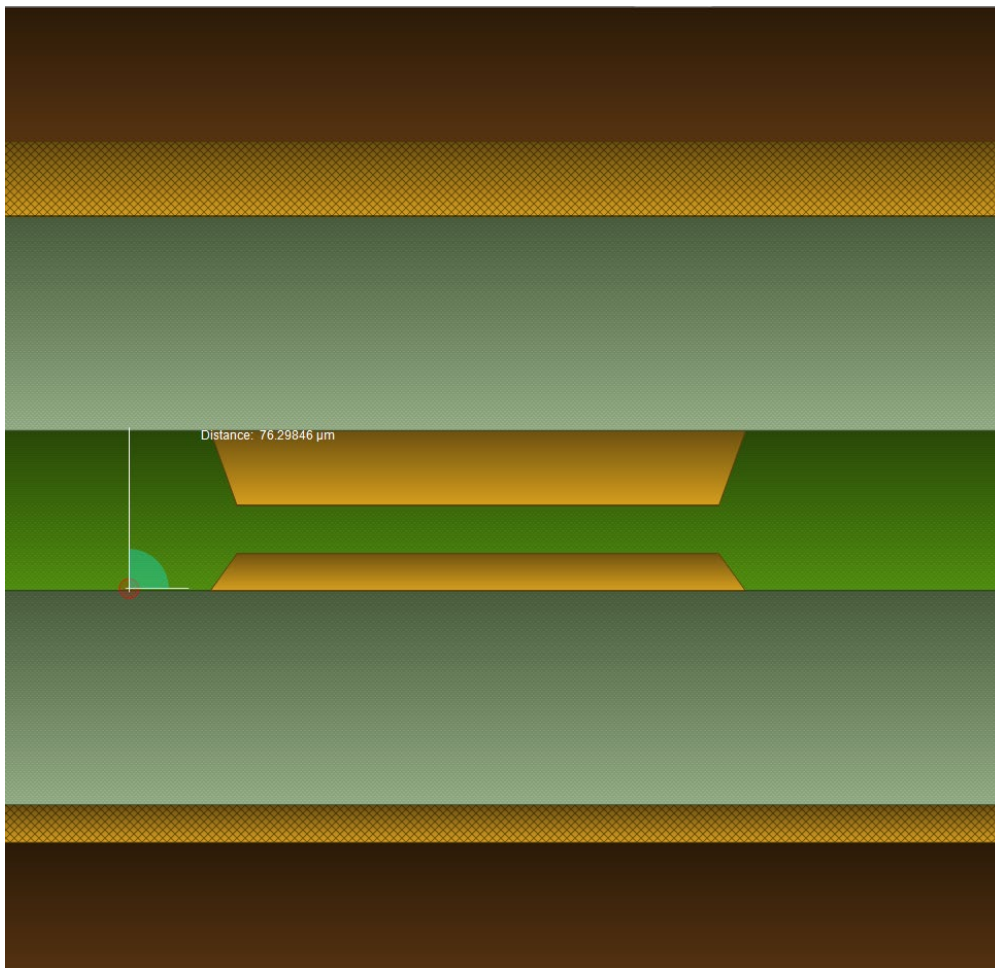

Zoom in as required and use the ruler to measure material dimensions, thicknesses, trace widths, etc.

Working with HDI builds

Speedstack HDI

For HDI PCB fabricators, Speedstack HDI provides the flexibility quickly to calculate the possible impact of substituting alternative materials to improve manufacturability and reduce cost while maintaining the specified parameters and performance of the board.

Easy graphical stackup display

The HDI Navigator provides a rapid guide through the sequential sub-stack lamination sequence and presents the complete assembly in a parsed graphical display that shows each phase of the multi-step lamination sequence of an HDI PCB.

User-definable settings within the Navigator allow engineers to display layers in transparent, invisible or 3D mode.

Sub-stack reordering

Speedstack Navigator makes re-ordering and renaming sub-stacks quick and easy in HDI builds; sub-stacks can be simply moved left or right within the Navigator window.

HDI builds

Use the Speedstack Navigator to document HDI press/drill cycles. Speedstack can document press cycles based on foil locations or drill start and end layers.

Sequential plan

The Sequential plan command creates sub-stacks that represent each press cycle in a sequential lamination from the Master stack based on foil locations.

Drill plan

Using Drill Plan, Speedstack determines the sub-stacks by the start / end layers of the drills.

Creating the target stack with the Stack Editor

Consider the target stack below – it will require three press cycles. Build and document the stack in the Stack Editor.

Switch to 2D View.

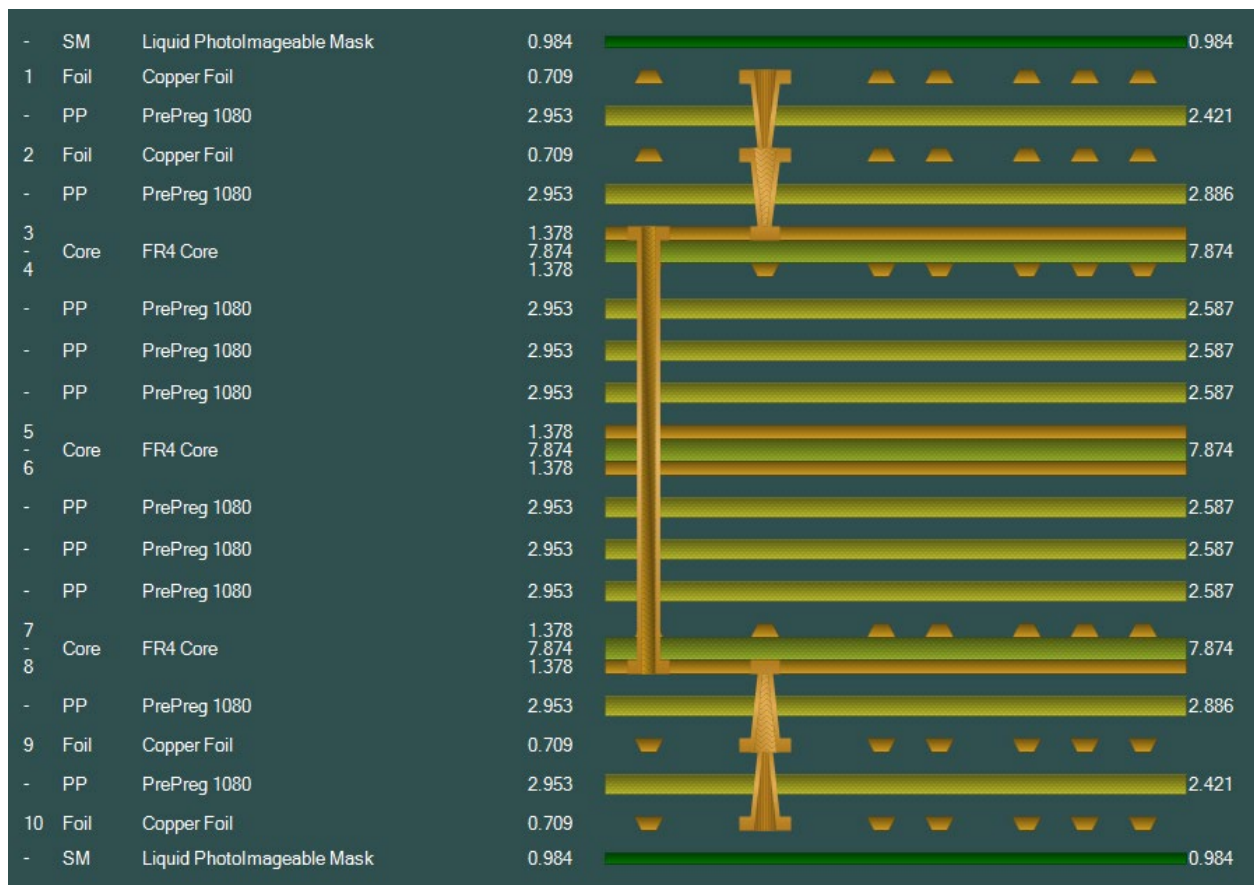

With the target stack completed use the Navigator's Add Stack to document each press cycle, building up the stack in the Navigator. Press F4 to start the Navigator and display the master stack.

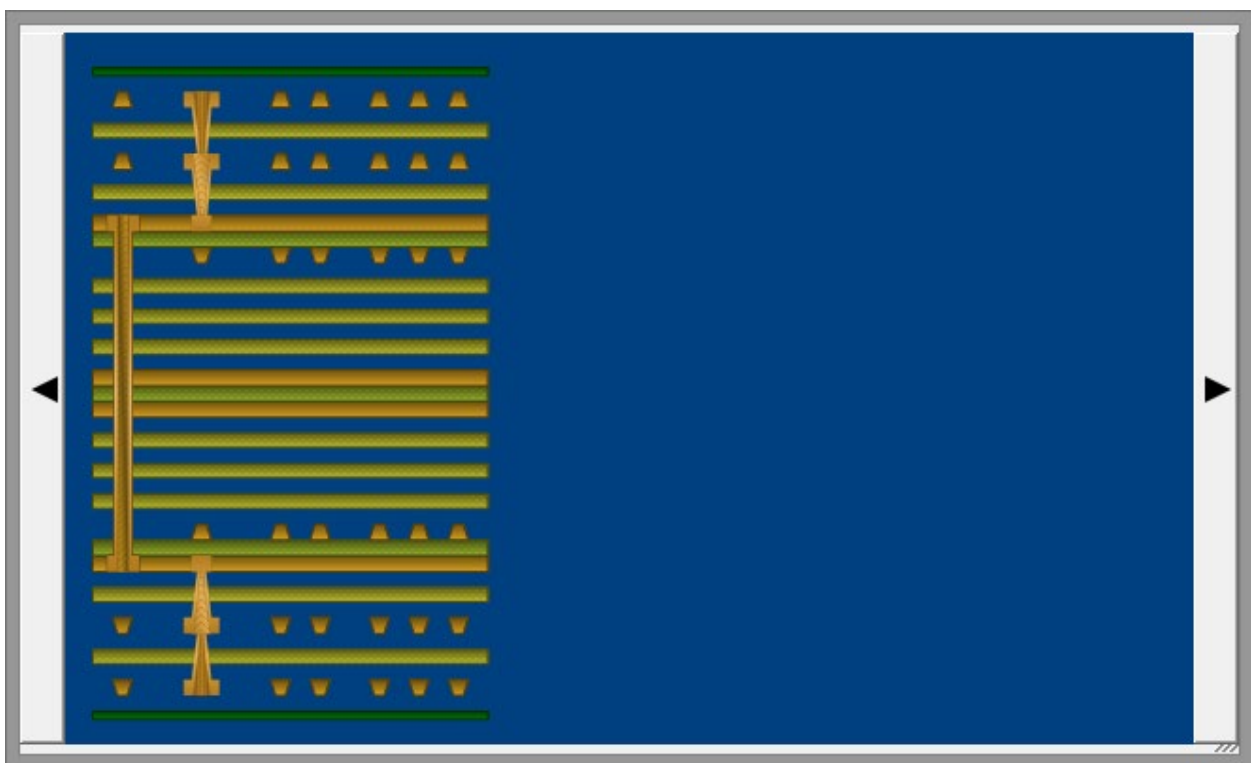

Click Add Stack to copy the stack and name the new sub-stack Press cycle 2.

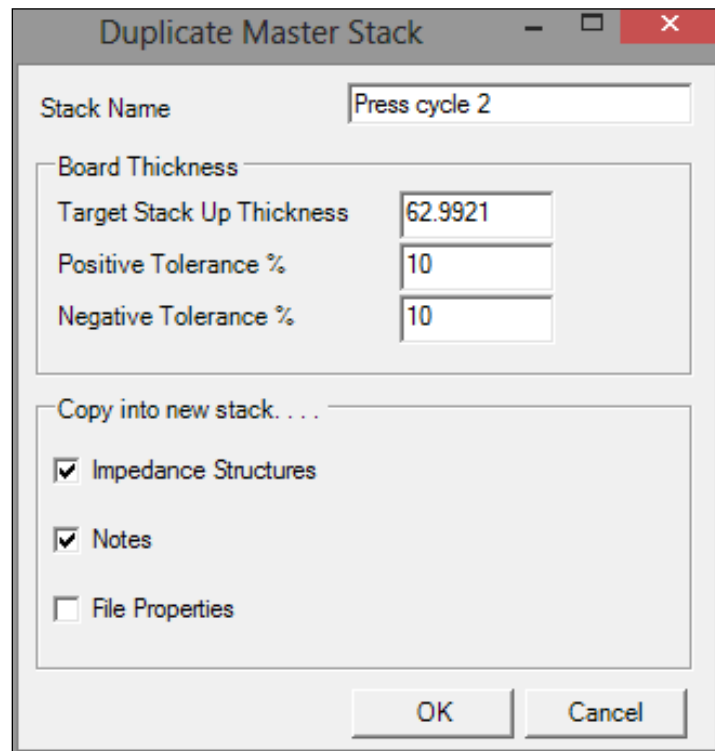

The new sub-stack is copied into the Navigator window.

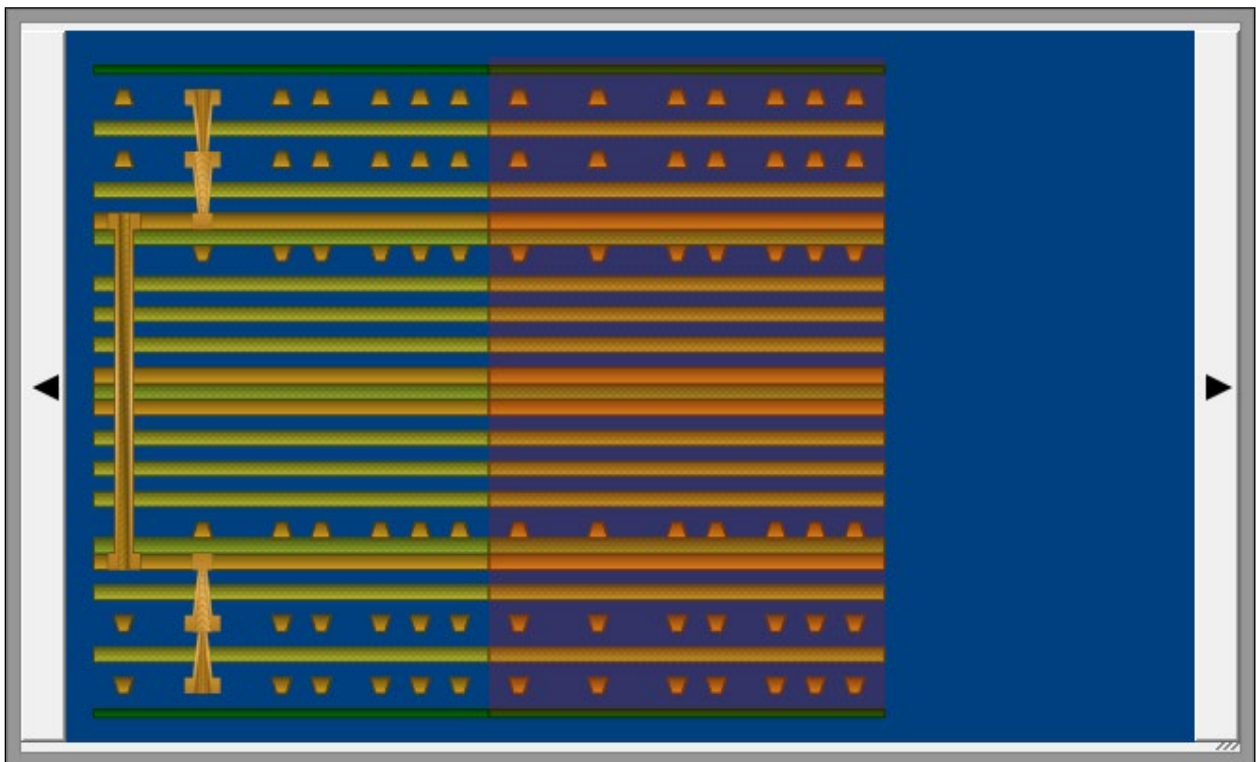

To edit the sub-stack to illustrate the press cycles, click the sub-stack to display it in the Stack Editor.

Enabling/disabling materials in the sub-stack

Utilize the Stackup Editor to add the drills and, optionally, to disable the materials that are added in each press cycle.

Note that if Symmetrical mode has been selected, material will be disabled both at the top and bottom of the stack.



Symmetrical Mode

With the sub-stack selected in the Stackup Editor, right click the sub-stack, select the materials to be disabled – i.e., in this case the materials added in the final press cycle, see the graphic below – and choose Flex-Rigid and then choose Disable Material

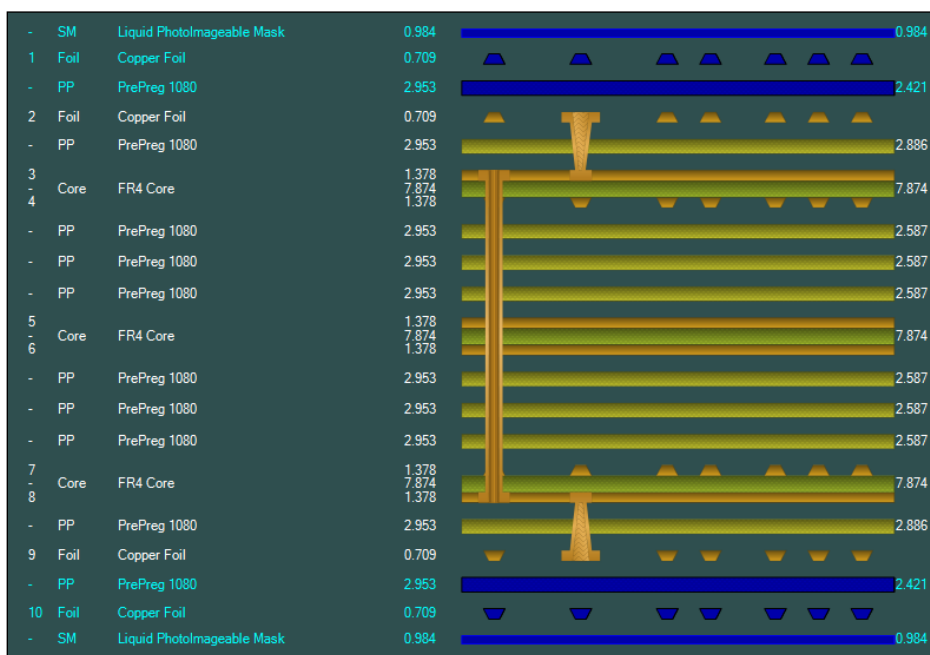

Disabled materials are shown in blue and will be removed from the sub-stack display to illustrate the press cycle.

The Navigator now displays the press cycle alongside the master stack.

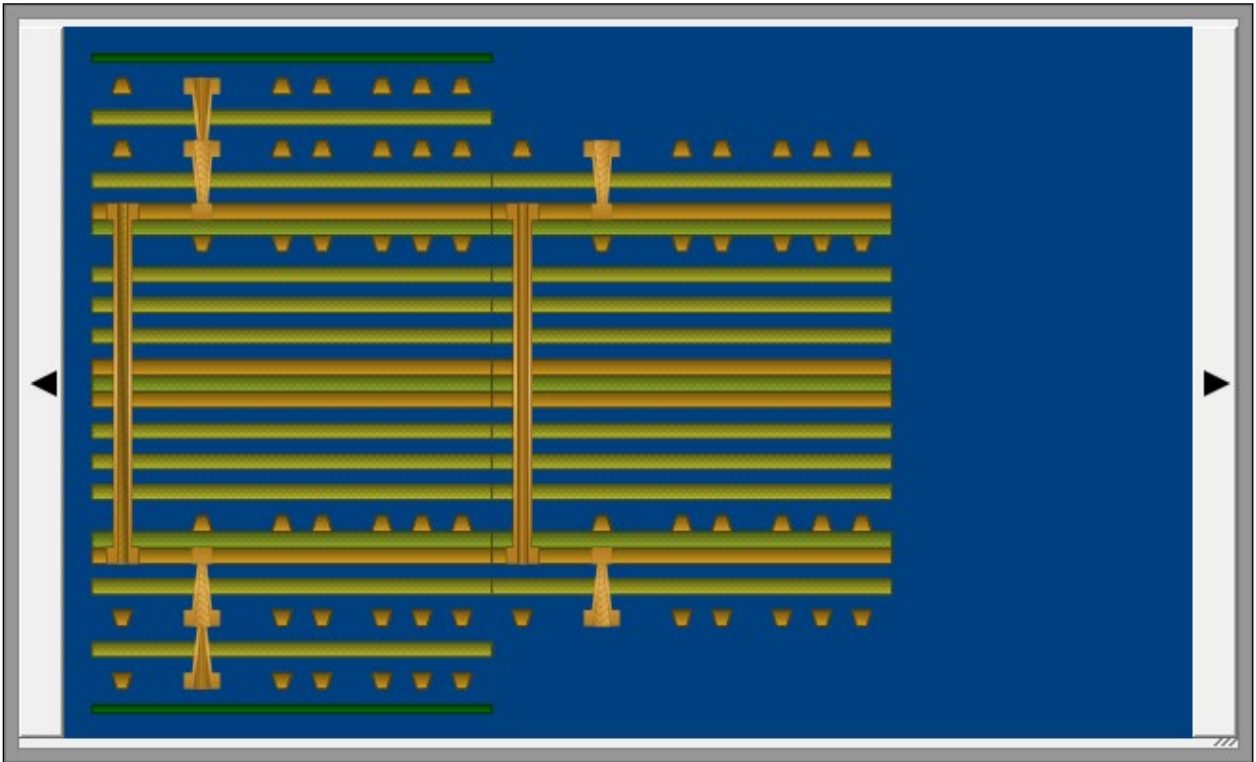

The sub-stack can be displayed either to the right or left of the master stack. Right click the sub-stack and from the context menu choose Move Left.

Sub-stack Press cycle 2 is now shown to the left of the master stack.

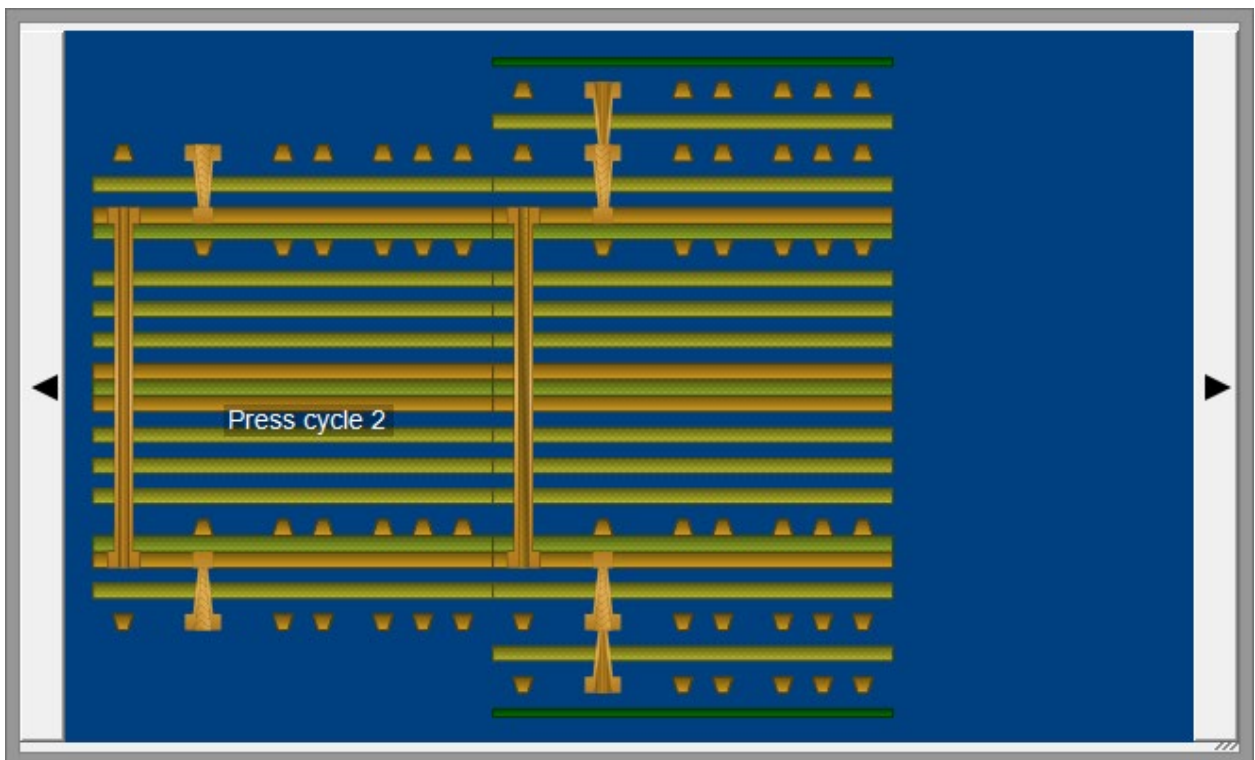

To add the next press cycle, right click the sub-stack and choose Copy and Paste Stack and position the new sub-stack to the far left.

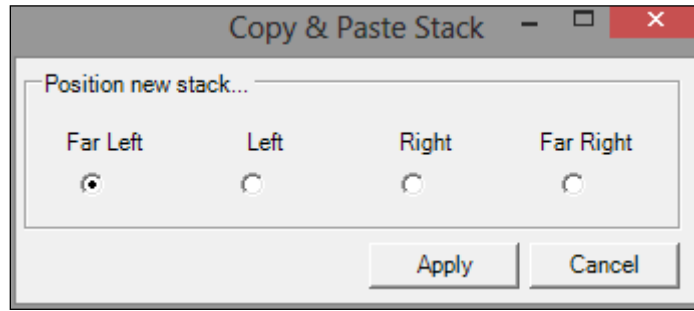

Modify the new sub-stack, disabling materials added in the first press cycle, in the Stack Editor as previously described and display the completed stack in the Navigator.

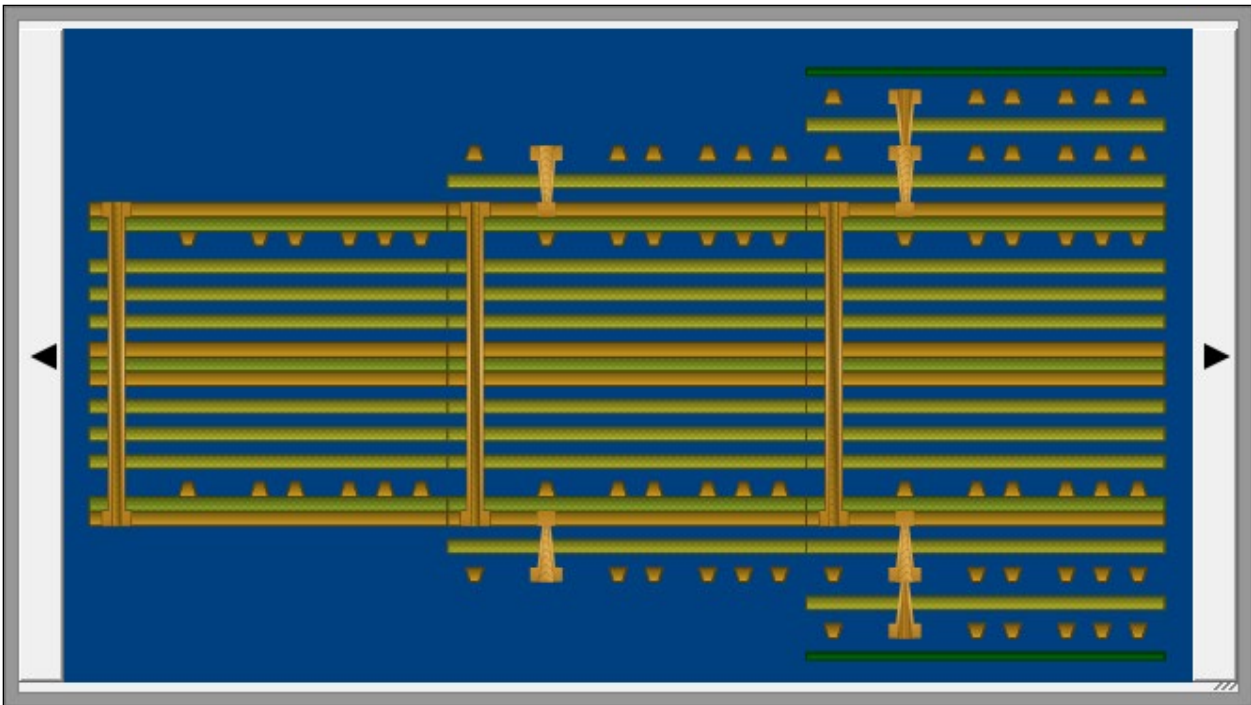

Each press cycle appears as a separate stack, progressing from left to right, in the Navigator.

Exposing the cores

In the fabrication process the manufacturer will process all the core materials first, prior to bonding where each core is interleaved with prepreg materials. It is sometimes useful, therefore, to see all the core materials on a single sub-stack.

Right click the Navigator window and choose HDI Build|Expose Cores to display the core layers.

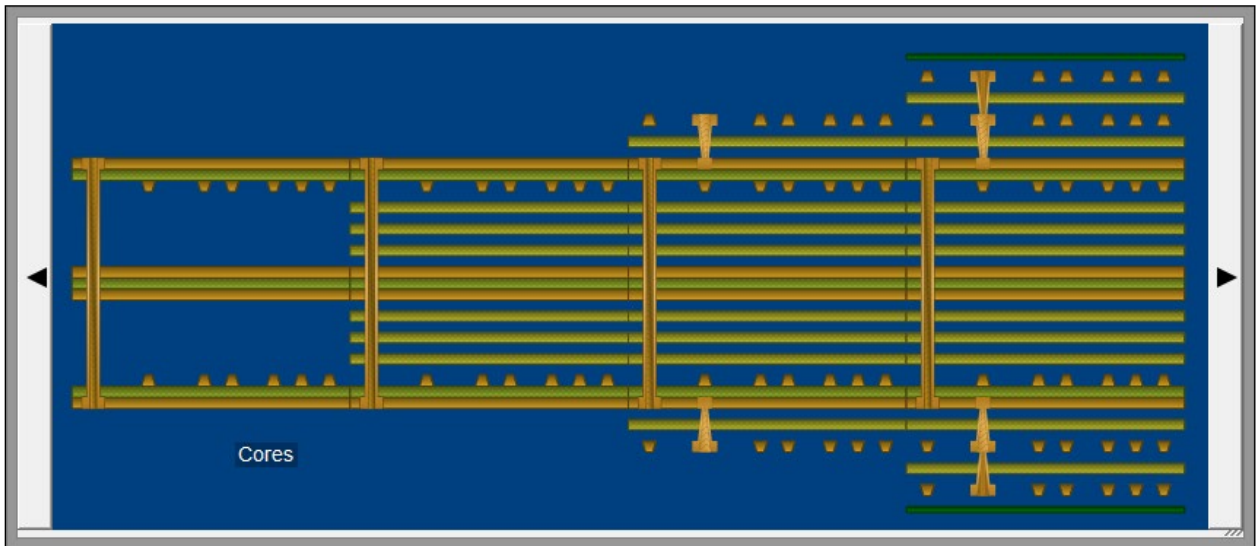

Using the Sequential Plan

Sequential Plan creates sub-stacks that represents each press cycle in a sequential lamination from Master stack based on foil locations. Consider the 14-layer stack below – this stack will need several press cycles to manufacture.

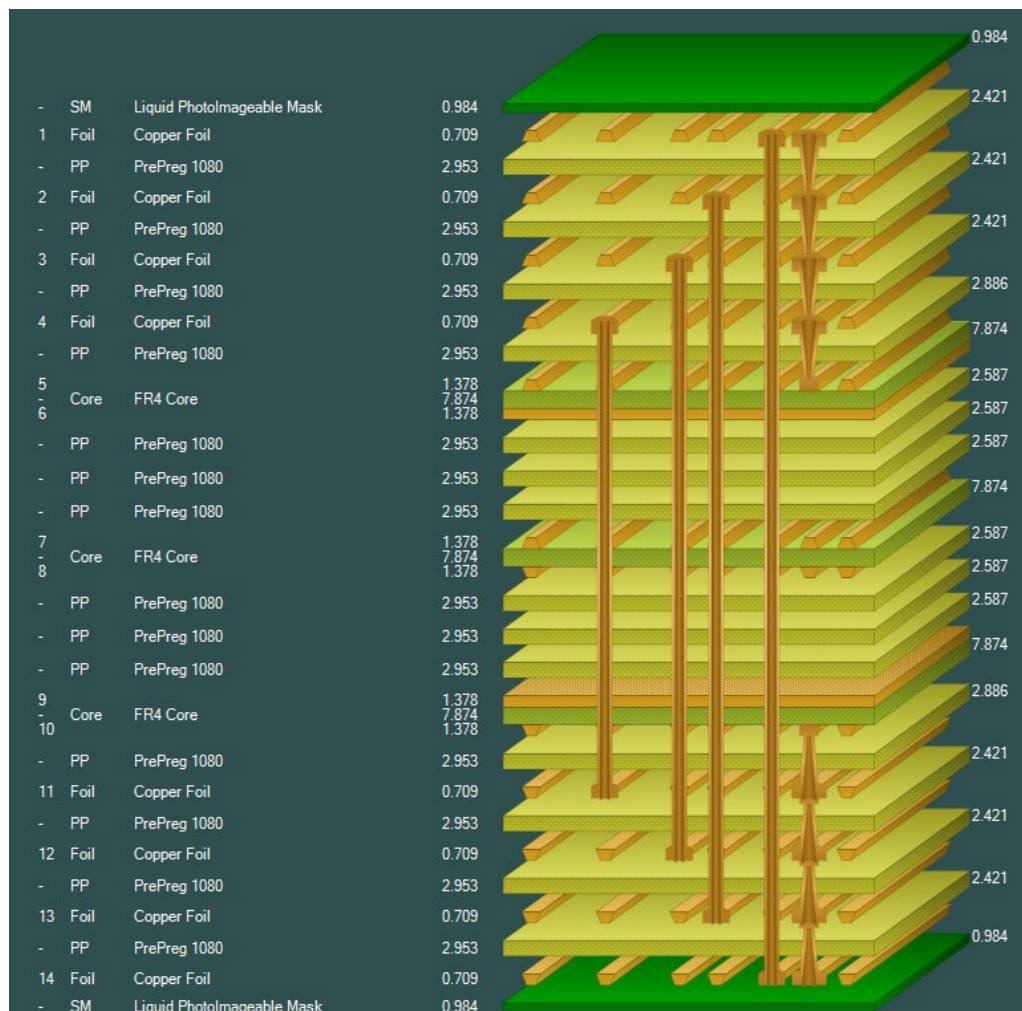

Opening the Navigator will display the completed master stack (shown below) in the Navigator window.



Right click the Navigator window and choose HDI Build |Sequential Plan and name the sub-stacks:

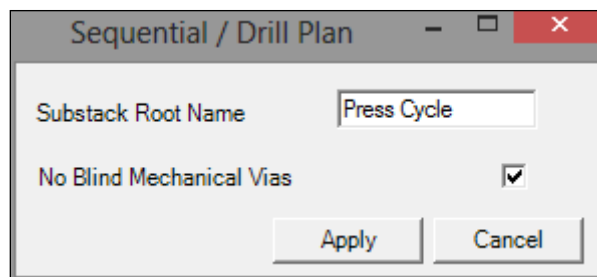

Click Apply – the Navigator displays the 4 press cycles

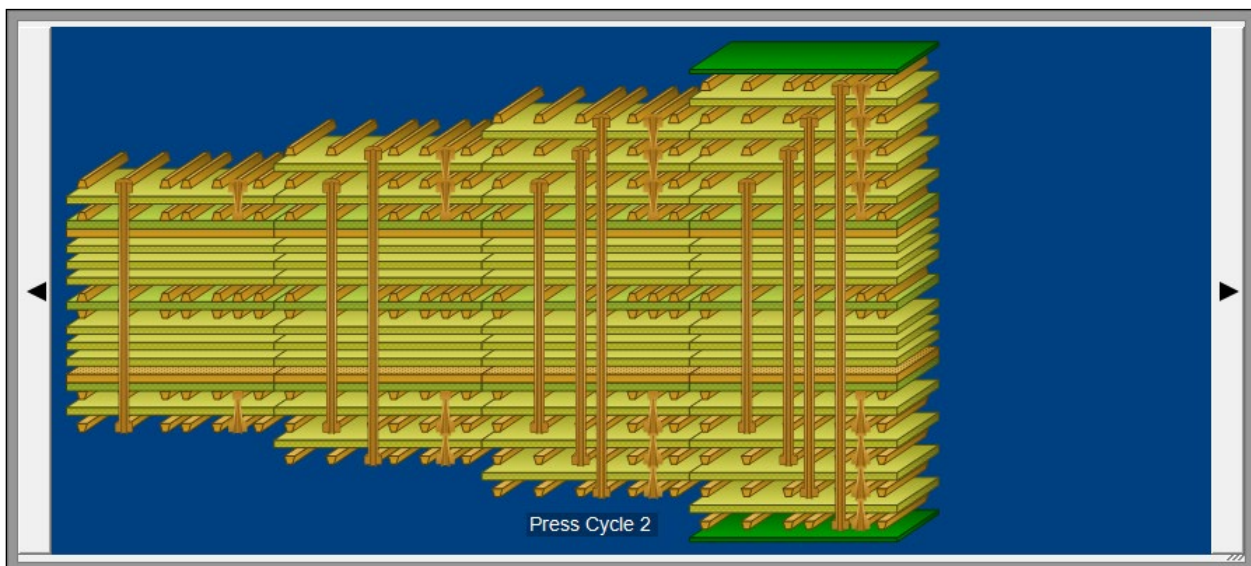

Choose HDI Build|Expose Cores – the cores are displayed in the Navigator window alongside the press cycles.

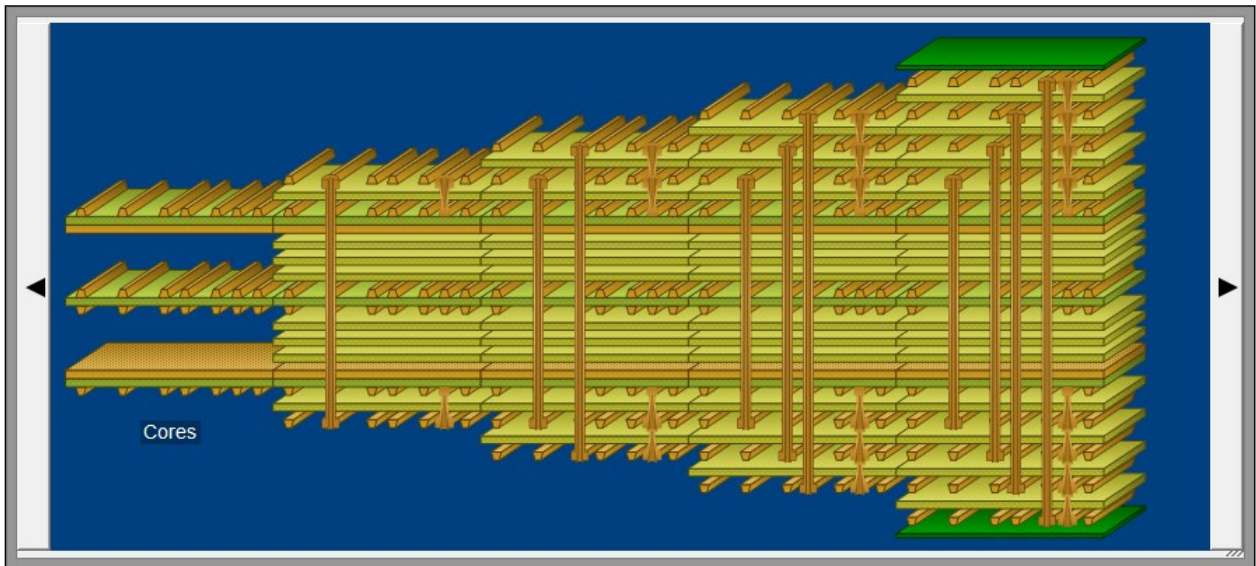

Using the Drill Plan

The HDI Build|Drill Plan creates sub-stacks that represents each press cycle from the Master stack based on drill start-end layers. Consider the stackup below – a 10 layer sequential lamination construction.

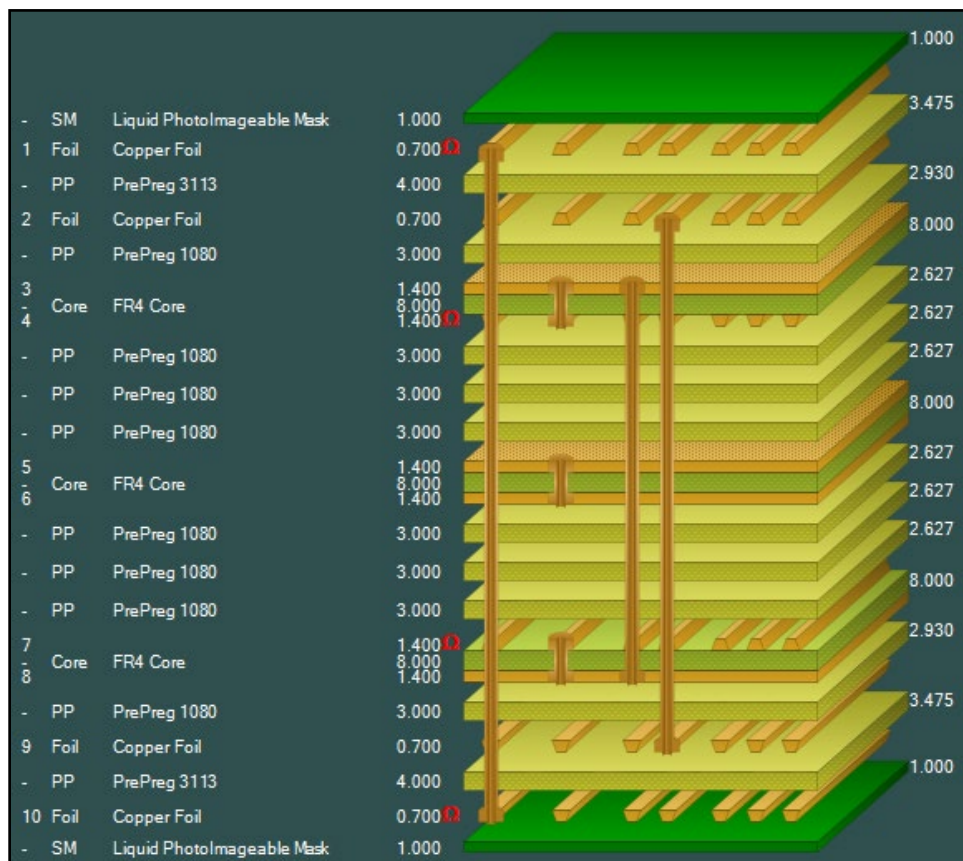

Press the F4 key to open the Navigator

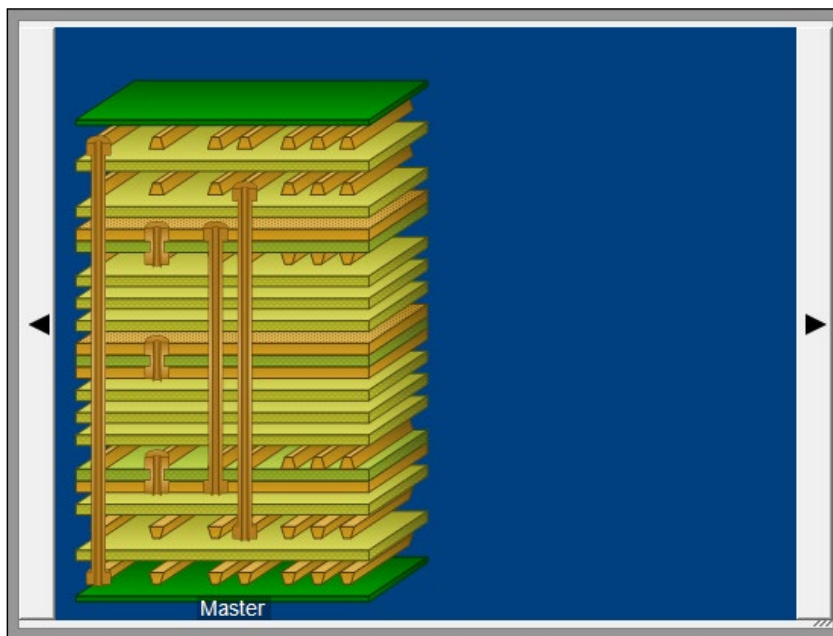

The completed Master stack is displayed. Right click the Navigator and choose HDI Build|Drill Plan.

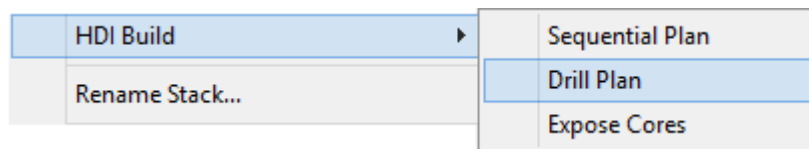

Supply the Sub-stack root name – the name will be used when numbering the press-drill cycles.

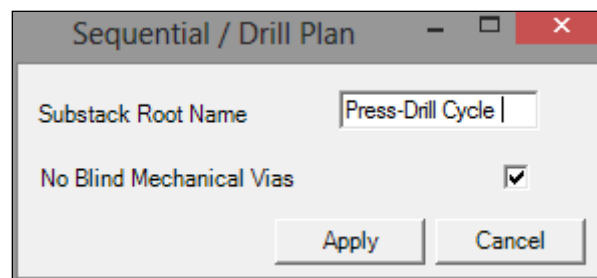

Click Apply – Speedstack documents the build-up stages of the sequential lamination.

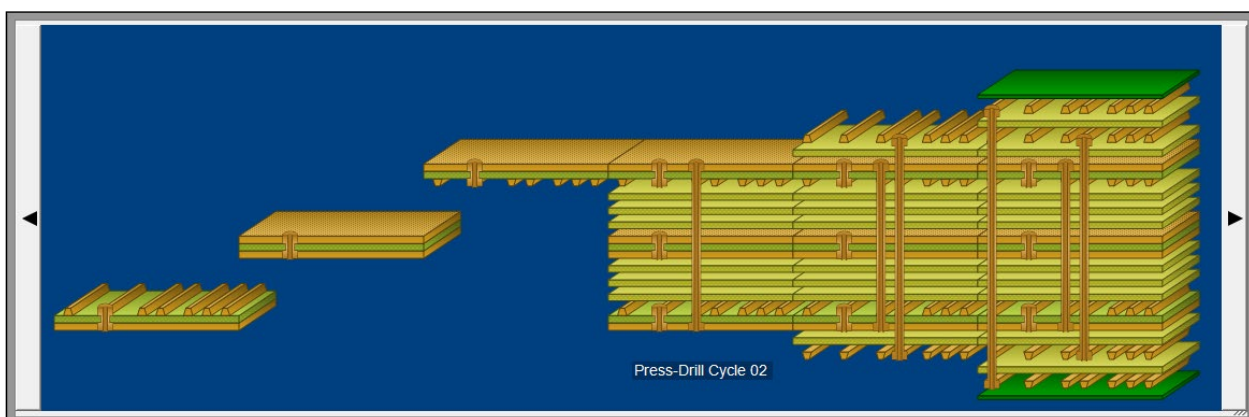

Exposing cores

Right click the Navigator and choose HDI Build|Expose Cores – the cores are shown alongside the press cycles.

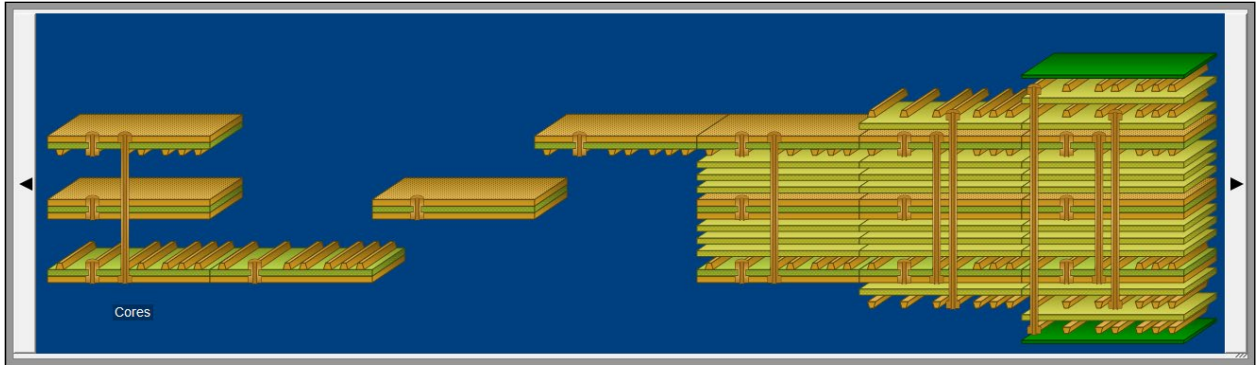

There are no limits to the number of press cycles that may be documented.

Working with multiple press cycles

The stack below is a 24 layer stack with multiple press-drill cycles. Open the Navigator, choose HDI Build|Drill Plan.

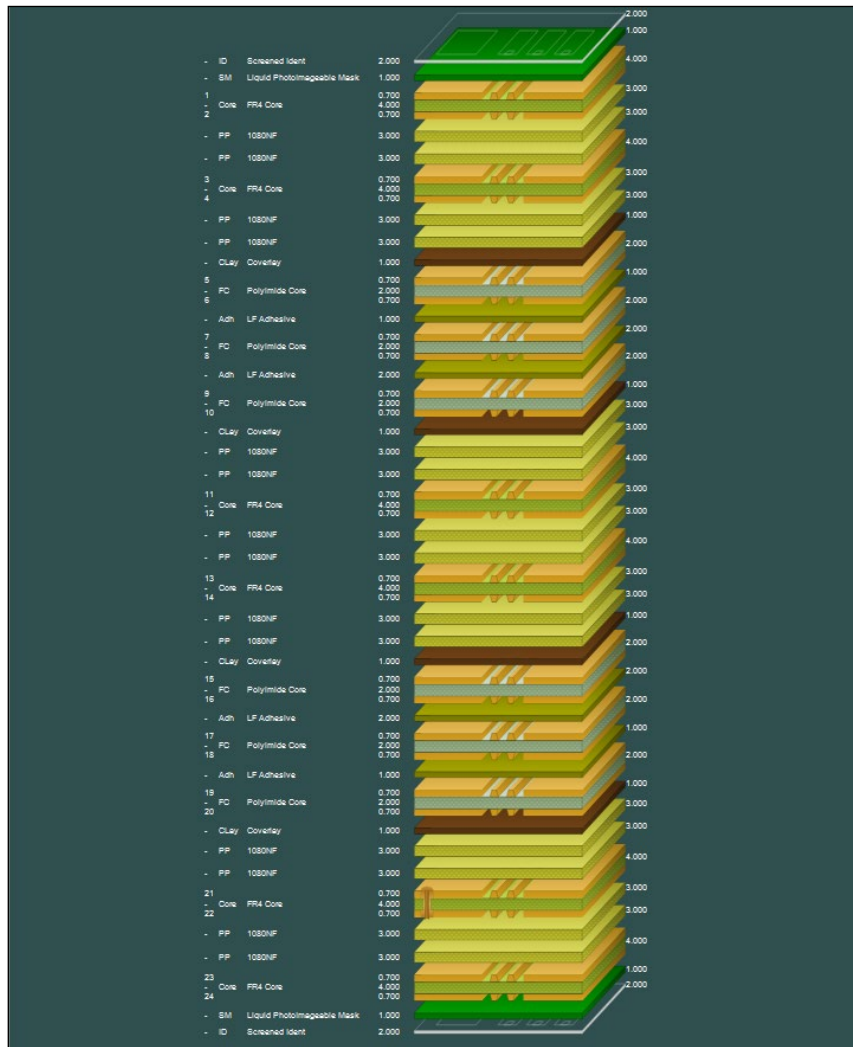

The Navigator displays the drill plan and cores below:

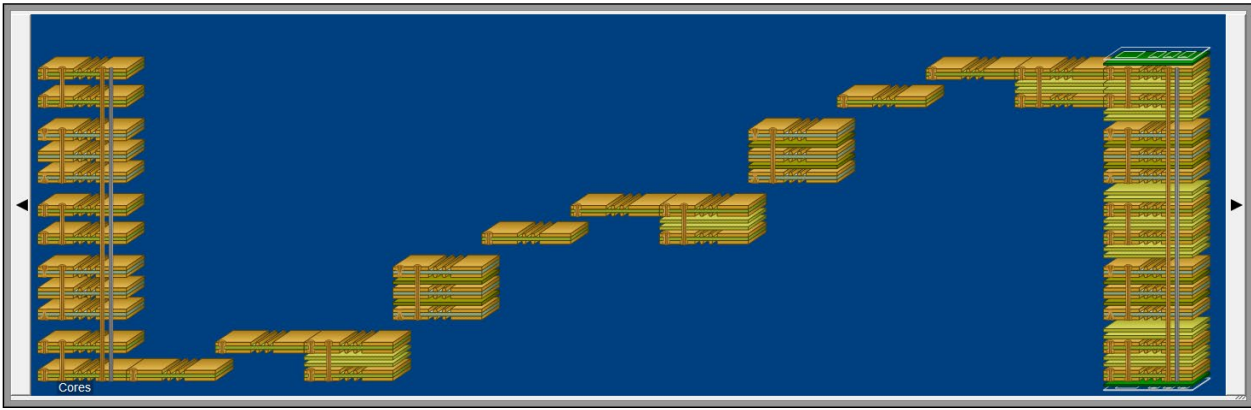

Printing the Navigator screen

From the File menu choose Print Technical Report – Speedstack prints the Navigator screen with its press cycles along with individual stack data, impedance data and drill data tables.

Using Speedstack materials libraries



Materials Library

The materials libraries are collections of the materials used in the process of designing stackups. Users can create and manage their own libraries of board materials or use libraries pre-built and provided by material suppliers. Using pre-built libraries can ensure accuracy and save considerable time during stackup design. Speedstack allows libraries to be created and materials added. Up to date libraries of materials may be downloaded from the Polar Online Material Library. Click the Materials Library button to display the Materials Library window.

Working with the materials libraries

When Speedstack is started the materials library specified as the default materials library file (selected via the Tools|Options|File Locations dialog below) is opened.

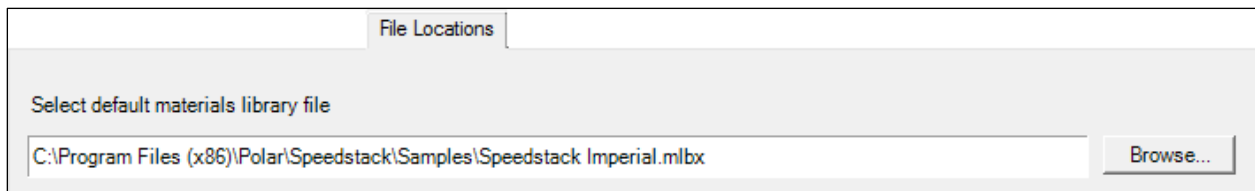

The dialog includes the data grid displaying the contents of the loaded library and the associated library filter.

Each library component type is accessible via its associated tab. Click on each tab to view or edit the component type.

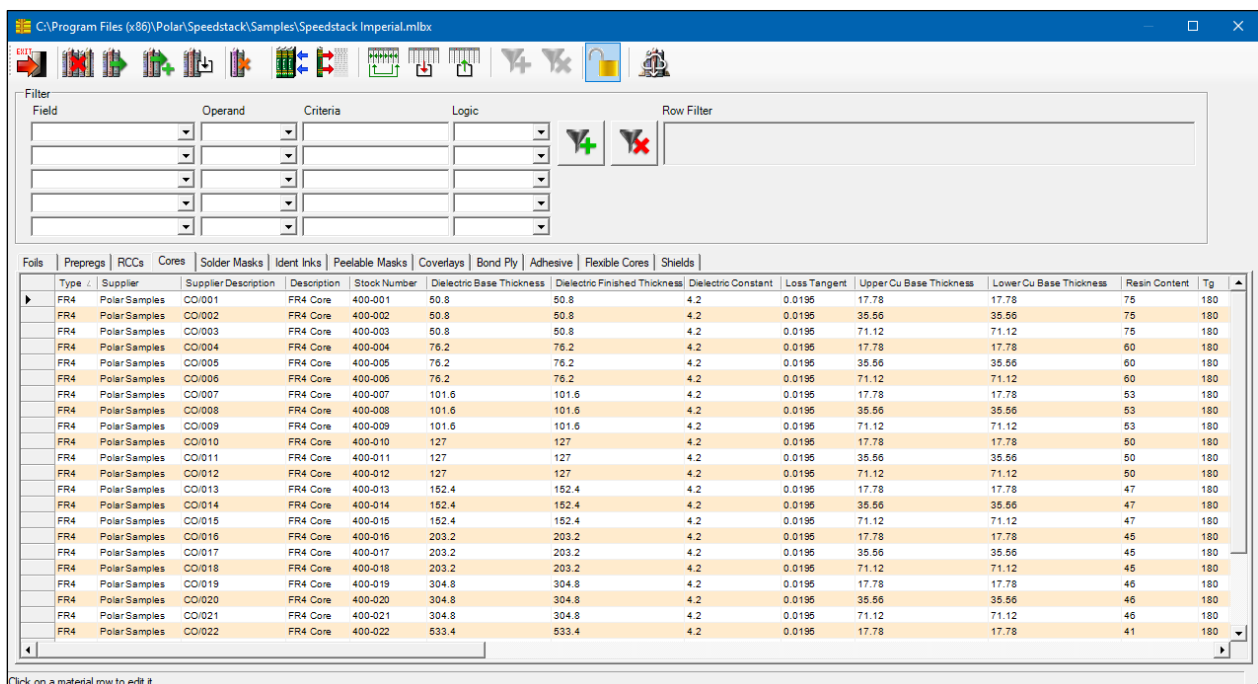

Click on a material row to edit it

Materials library toolbar

Use the toolbar to load and save libraries, import or export libraries, arrange data columns or access the online or on-premise libraries. The Toolbar and button functions are shown below.



Exit library



Clear materials library



Open materials library



Open and Append



Save materials library



Clear current data table



Import CSV library



Export CSV library



Select & arrange column fields



Save column order



Load column order



Library lock



Online / on-premise library

Library filter toolbar

Use the library filter toolbar to filter materials by data field



Set filter



Clear filter



Open Materials Library

Opening a library

To open, or load, a library, click the Open Library icon and browse to the library; click Open – the currently loaded library will be replaced.



Open and Append Library

Opening and appending a library

To open a library and add the materials to an existing library click the Open and Append Library icon, browse to the library and click Open: the material will be added to the existing library table.

Filtering Materials

When adding or swapping materials, available materials (Foil, Prepregs, etc.) are listed in the associated material library data grid. Lists can be filtered for materials matching desired parameters (for example, dielectric thickness, Er, loss tangent, etc.)

Filter						
Field	Operand	Criteria	Logic			Row Filter
<input type="text"/>	<input type="text"/>	<input type="text"/>	<input type="text"/>			
<input type="text"/>	<input type="text"/>	<input type="text"/>	<input type="text"/>			
<input type="text"/>	<input type="text"/>	<input type="text"/>	<input type="text"/>			
<input type="text"/>	<input type="text"/>	<input type="text"/>	<input type="text"/>			
<input type="text"/>	<input type="text"/>	<input type="text"/>	<input type="text"/>			

To list only materials matching required characteristics, specify the criteria in the filter drop-downs and text boxes and apply the filter.

Filtering for an exact match

For example, to select materials with a dielectric base thickness of 3.937 mil select the field and operand and specify the criteria, then click Apply.



Filter						
Field	Operand	Criteria	Logic			Row Filter
Base Thickness	=	3.937				Base Thickness = 3.937
<input type="text"/>	<input type="text"/>	<input type="text"/>	<input type="text"/>			
<input type="text"/>	<input type="text"/>	<input type="text"/>	<input type="text"/>			
<input type="text"/>	<input type="text"/>	<input type="text"/>	<input type="text"/>			
<input type="text"/>	<input type="text"/>	<input type="text"/>	<input type="text"/>			

	Foils	Prepregs	RCCs	Cores	Solder Masks	Ident Inks	Peelable Masks	Coverlays	Bond Ply	Adhesive	Flexible Cores	Shields
	Type	Supplier	Supplier Descripti	Description	Stock Number	Dielectric Base Thickness	Dielectric Finished Thickness	Dielectric Constant	Loss Tangent			
▶	FR4	Polar Samples	CO/007	FR4 Core	400-007	3.937	3.937	4.2	0.0195			
	FR4	Polar Samples	CO/008	FR4 Core	400-008	3.937	3.937	4.2	0.0195			
	FR4	Polar Samples	CO/009	FR4 Core	400-009	3.937	3.937	4.2	0.0195			

The matching materials are displayed, along with the row filter criteria.

Filtering with multiple criteria

Multiple conditions may be specified with AND/OR logic.

Filter				Row Filter
Field	Operand	Criteria	Logic	
BaseThickness	=	3.937	AND	  BaseThickness = 3.937 AND UpperCuThickness = 1.378
UpperCuThickness	=	1.378		

Type	Supplier	Supplier Descripti	Description	Stock Number	Dielectric Base Thickness	Dielectric Finished Thickness	Dielectric Constant	Loss Tangent	Upper Cu Base Thickness
FR4	Polar Samples	CO/008	FR4 Core	400-008	3.937	3.937	4.2	0.0196	1.378



Use the AND/OR logic field to add each new condition:

Example: BaseThickness = 3.937 AND UpperCuThickness = 1.378 AND DielectricConstant = 4.2 AND LossTangent < 0.02

The conditions are shown specified in the graphic below.



Apply Filter

Filter				Row Filter
Field	Operand	Criteria	Logic	
BaseThickness	=	3.937	AND	  BaseThickness = 3.937 AND UpperCuThickness = 1.378 AND DielectricConstant = 4.2 AND LossTangent < 0.02
UpperCuThickness	=	1.378	AND	
DielectricConstant	=	4.2	AND	
LossTangent	<	0.02		

Type	Supplier	Supplier Descripti	Description	Stock Number	Dielectric Base Thickness	Dielectric Finished Thickness	Dielectric Constant	Loss Tangent	Upper Cu Base Thickness	Lower Cu Base Thickness	Resin
FR4	Polar Samples	CO/008	FR4 Core	400-008	3.937	3.937	4.2	0.0196	1.378	1.378	53



Filtering for an inexact match with Like

Use the Like operand to search for a specified pattern in a column. Use wildcard characters * or % to represent zero or more characters.

For example,

Like *1080 returns all lines ending in "1080"

Like *1080* – below – returns all lines containing "1080"

Filter				Row Filter
Field	Operand	Criteria	Logic	
Description	Like	*1080		  Description Like "*1080"

Description	Dielectric Base Thickness	Dielectric Finished Thickness	Dielectric Constant	Loss Tangent	Upper Cu Base Thickness	Lower Cu Base Thickness	Resin Content
1x1080	64	64	3.62	0.0089	18	18	57
1x1080	64	64	3.62	0.0089	35	35	57
1x1080	64	64	3.62	0.0089	70	70	57
1x1080	76	76	3.5	0.0092	18	18	63
1x1080	76	76	3.5	0.0092	35	35	63
1x1080	76	76	3.5	0.0092	70	70	63
1x106/1x1080	102	102	3.58	0.009	18	18	59
1x106/1x1080	102	102	3.58	0.009	35	35	59
1x106/1x1080	102	102	3.58	0.009	70	70	59
1x106/1x1080	109	109	3.54	0.0092	18	18	61
1x106/1x1080	109	109	3.54	0.0092	35	35	61



Clear Filter

Click Clear Filter to return to displaying all materials.

On exiting the library window, Speedstack prompts to save the library.

Creating a new library



Clear Library

To create a new library, click Clear Library to clear the currently loaded materials; the library is removed from the library manager.



Import CSV Library

Import materials (usually supplied in comma separated values format) as described below and save the library.

Loading the new library at start up

Click Save Materials Library and supply a name and destination folder to create the new library.



Save Materials Library

To have the library load as Speedstack starts, specify it as the default materials library file via Tools|Configuration Options|File Locations as described earlier.

Importing material to the Speedstack materials library

Speedstack allows users to add existing material lists (usually supplied from the material manufacturer's data sheets) to its library; material data must be arranged in the format and order used by the Speedstack library.

Library materials can be imported from the Polar Online / On-Premise Library or from local library files.

Importing from local material files

Prior to importing the material data file ensure the file is not open in another process (for example, in Microsoft® Excel®.)



Import CSV Library

Click the Speedstack Materials Library button to open the Library, and then click Import CSV Library to open the Import Library dialog.

The screenshot shows the Speedstack software interface. The toolbar at the top contains various icons, with the 'Import CSV Library' icon (a library icon with two blue arrows) highlighted with a red box. Below the toolbar is a 'Filter' section with a table for defining filter criteria. At the bottom, there is a data table with columns for material properties.

Field	Operand	Criteria	Logic	Row Filter

Type	Supplier	Supplier Description	Description	Stock Number	Dielectric Base Thickness	Dielectric Finished Thickness	Dielectric Constant	Loss Tangent
FR4	Polar Samples	CO/001	FR4 Core	400-001	50	50	4.2	0.0195
FR4	Polar Samples	CO/002	FR4 Core	400-002	50	50	4.2	0.0195

When importing materials set the Import options in the Import Library dialog: specify the units, delimiter and material type and specify whether the material will be used to clear the current data table or append to the existing library.

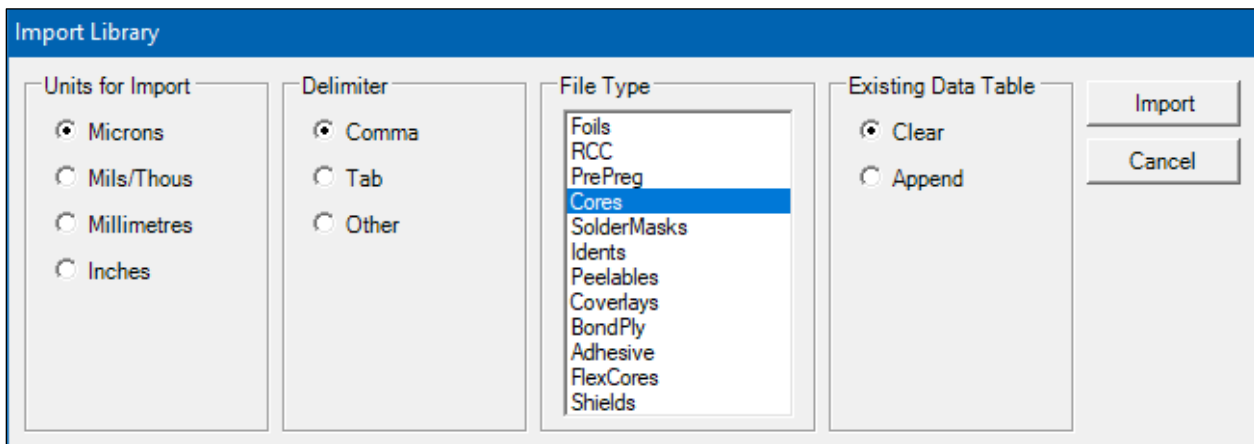

Replacing existing material tables

Choose the Clear Existing Data Table option and choose the field delimiter type. The library import function can accept files in a variety of formats: tab delimited, comma separated and Excel worksheet and template formats but must match the arrangement of the supplied sample files with columns in the correct order. Specify the units for import, file delimiter and choose the file type (Foil, RCC, Prepreg, etc.) and click Import. Navigate to the file via the Open dialog and click Open. Repeat the procedure for every file type to be imported. Save the resulting files as .mlbx library files.

Adding material data to an existing library

To add material data to an existing library table, open the library, click Import CSV Library, click the Append to Existing Data Table and click Import.

Navigate to the .csv or .txt file and click Open. Save the modified library file as a .mlbx file.

Exit the library when all file types have been imported.

Adding new material to the data tables

Caution: ensure consistency of units

When defining dimensions, e.g., layer thicknesses, for a stackup ensure that all measurements are defined using the same units (mils, mm, etc.) throughout the structure and its associated libraries.

Open the library to be modified. To add individual materials to a library, click the associated component type tab; click onto a material, or empty line. An editing box will open which will contain the material clicked on, or the last material in that type library.

Review/Edit Cores			
Supplier	<input type="text" value="Polar Samples"/>	Size	<input type="text" value=""/>
Supplier Description	<input type="text" value="CO/022"/>	Note 1	<input type="text"/>
Description	<input type="text" value="FR4 Core"/>	Note 2	<input type="text"/>
Stock Number	<input type="text" value="400-022"/>	Note 3	<input type="text"/>
Type	<input type="text" value="FR4"/>	Note 4	<input type="text"/>
Base Thickness	<input type="text" value="540.00"/>	Note 5	<input type="text"/>
Finished Thickness	<input type="text" value="540.00"/>		
Dielectric Constant	<input type="text" value="4.2"/>		
Loss Tangent	<input type="text" value="0.0195"/>		
Resin Content	<input type="text" value="41"/>		
Tg	<input type="text" value="180"/>		
Td	<input type="text" value="0"/>		
CAF Resistance	<input type="text" value="0"/>		
Z Axis Expansion	<input type="text" value="0"/>		
Tolerance +/-%	<input type="text" value="10"/>		
Upper Cu Thickness	<input type="text" value="18.00"/>		
Lower Cu Thickness	<input type="text" value="18.00"/>		
Cost	<input type="text" value="22"/>		
Lead Time	<input type="text" value="0"/>		
Use in Auto Stack	<input checked="" type="checkbox"/>		
Planes Both Sides	<input type="checkbox"/>		
Laser Drillable	<input type="checkbox"/>		
<input type="button" value="Add"/> <input type="button" value="Delete"/>		<input type="button" value="22 of 29"/>	
		<input type="button" value="OK"/>	

The material can be edited or deleted, or a new material can be added. To speed up the process of adding families of materials, when a material is added the properties of the last material are copied to the new material. The details can then be edited. Clicking OK will add any new materials to the end of the list.

Importing material to the data tables

Speedstack allows users to add existing material lists to its library; material data must be arranged in the format and order used by the Speedstack library.

Contact Polarcare@polarinstruments.com

Library sample files

Sample files for all material types in comma separated value format and Microsoft Excel spreadsheet and template formats suitable for importing to Speedstack are available on request from Polar Instruments.



Import CSV Library

Click the Materials Library button to open the Library, and then click Import CSV Library to open the Import dialog.

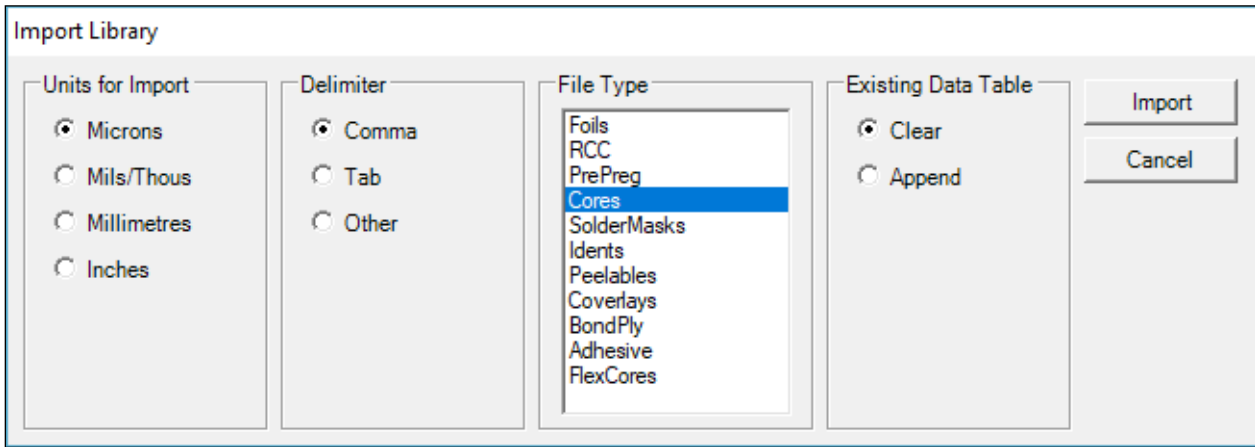

Choose Clear or Append to Existing Data Table as appropriate.

Creating a new materials library table

Choose Clear Existing Data Table, click Export Library as CSV and choose microns as units and the field delimiter type and click Export. The data table is exported as a “template”.

Open the file in a suitable text file editor – the file below is opened in Microsoft Excel and shows the file header rows with the column headers in the order and format expected by the Speedstack library manager. Add the material data to the associated columns and save in text format. As noted above, templates for all materials are available on request from Polar Instruments. Contact polarcare@polarinstruments.com

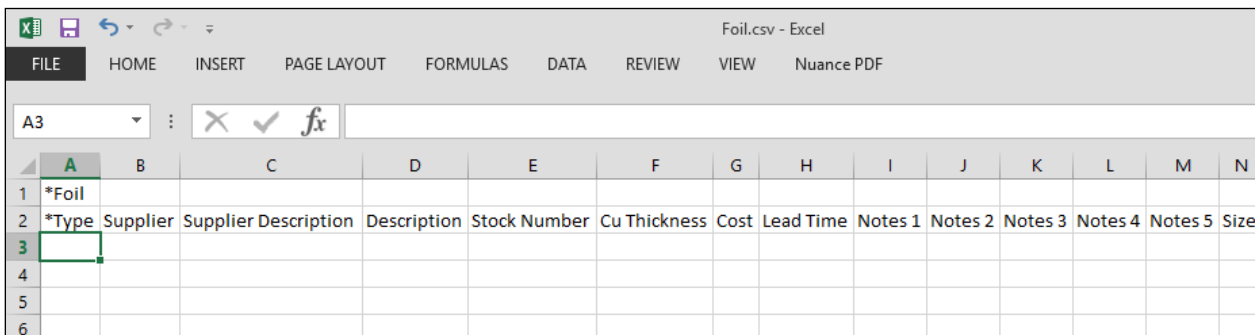

Empty Foils library table

The library import function can accept files in a variety of formats, tab delimited, comma separated and Excel worksheet and template formats.

Sections of the sample files suitable for Speedstack are shown below.

	A	B	C	D	E	F	G	H	I
1	* Cores								
2	*							Dielectric	Dielectric
3	*Type	Supplier	Supplier Description	Description	Stock Number	Upper Cu Thickness	Lower Cu Thickness	Base Thickness	Finished Thickness
4	FR4	Polar Samples	CO/001	FR4 Core	400-001	0.018	0.018	0.05	0.05
5	FR4	Polar Samples	CO/002	FR4 Core	400-002	0.035	0.035	0.05	0.05
6	FR4	Polar Samples	CO/003	FR4 Core	400-003	0.07	0.07	0.05	0.05
7	FR4	Polar Samples	CO/004	FR4 Core	400-004	0.018	0.018	0.075	0.075
8	FR4	Polar Samples	CO/005	FR4 Core	400-005	0.035	0.035	0.075	0.075
9	FR4	Polar Samples	CO/006	FR4 Core	400-006	0.07	0.07	0.075	0.075
10	FR4	Polar Samples	CO/007	FR4 Core	400-007	0.018	0.018	0.1	0.1
11	FR4	Polar Samples	CO/008	FR4 Core	400-008	0.035	0.035	0.1	0.1

Sample Cores library file in Microsoft Excel format

```
* Cores,,,,,,,,,,,,,,,,,,,,,,,,,,,,,
*,,,,,,,,,,Dielectric,Dielectric,Dielectric,Dielectric,Dielectric,Dielectric,Dielectric,Dielectric,Dielectric,Dielectric,,,,,,,,,
*Type,Supplier,Supplier Description,Description,Stock Number,Upper Cu Thickness,Lower Cu Thickness,Base Thickness,Finished Thickness,
Content,Tg,Td,CAF Resistance,ZAxisExpansion,ExcessResin,Tolerance,Cost,Lead Time,Notes 1,Notes 2,Notes 3,Notes 4,Notes 5,Size
FR4,Polar Samples,CO/001,FR4 Core,400-001,0.018,0.018,0.05,0.05,4.2,75,180,0,0,0,0,10,0,0,,,,,*
FR4,Polar Samples,CO/002,FR4 Core,400-002,0.035,0.035,0.05,0.05,4.2,75,180,0,0,0,0,10,0,0,,,,,*
FR4,Polar Samples,CO/003,FR4 Core,400-003,0.07,0.07,0.05,0.05,4.2,75,180,0,0,0,0,10,0,0,,,,,*
FR4,Polar Samples,CO/004,FR4 Core,400-004,0.018,0.018,0.075,0.075,4.2,60,180,0,0,0,0,10,0,0,,,,,*
```

Sample library file in comma separated format

Files for importing into the library must be in the above format, *with columns in the correct order*.

Specify the delimiter if necessary and choose the file type (Foil, RCC, Prepreg, etc.) and units for import and click Import and Clear or Append as required.

Choose the file from the list displayed in the Open dialog and click Open. Repeat the procedure for every file type. Save the file as a .mlbx library file.

Exit the library manager when all file types have been imported.

Adding material data to an existing library

To add material data to an existing library, open the library click Import CSV Library, click the Append to Existing Data Table and click Import.

Choose the .csv or .txt file and click Open. Save the modified Library file as a .mlbx file.

Selecting Materials from the Library

Arranging Columns in Library Forms

The Library windows can be customised in respect of which columns to display and in which order.

The default setting displays all columns. The columns displayed and the order they are displayed can be set in the materials Library form.



Arrange Columns

Click the Go to Materials Library button and Select and Arrange Columns; the dialog associated with the selected material tab (Foil, Prepregs, etc.) is opened.

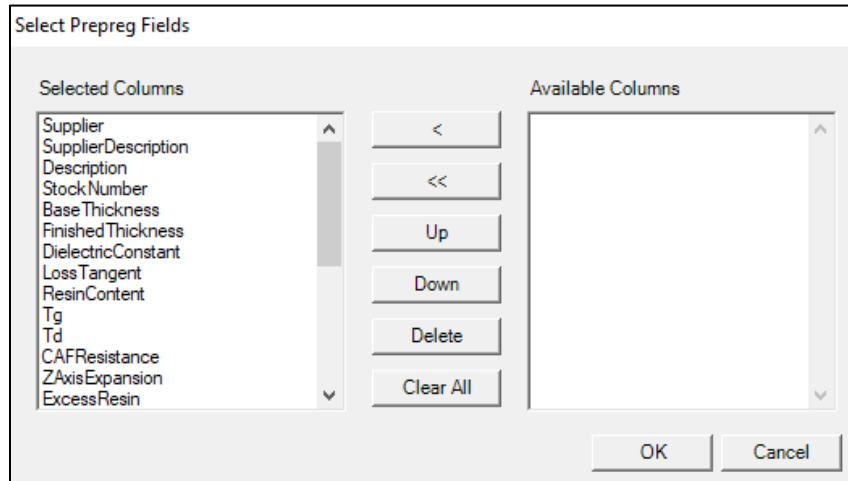

The Left box of the dialog shows the columns that will be displayed and the order top to bottom is the order they will be displayed left to right in the library window.

Click OK to return to the Materials Library, which will show the columns as set.



Save Column Order



Load Column Order

Until the column order is saved the column order is only available during the current session. Click Save Column Order to define the selected column order as the default order whenever the program is run.

Click Load column Order to apply a saved column arrangement.



Library Lock

Locking the library

The materials library can be locked and password protected to prevent unauthorised or accidental editing. If no password has been set the Material Library remains open for any changes and modifications.

To lock the library, click the Library Lock button and supply a password; the library is then locked and any editing requires the password to be entered (via clicking on the padlock). Once unlocked it will remain unlocked until Speedstack is closed or the padlock is clicked again.

Using the Online Library

The Online Library comprises the most up to date copies of the material files supplied from materials manufacturers who are members of the Polar Speedstack Supplier Partner program.

Each new version of Speedstack adds new and updated materials to the Polar online library; utilisation of the online library requires access to the internet.

Importing from the Polar Online Library

To add materials (Foils, Prepregs, etc.) from the online (or on-premise) library, choose the Open Materials Library icon and click the Online Library icon highlighted below.

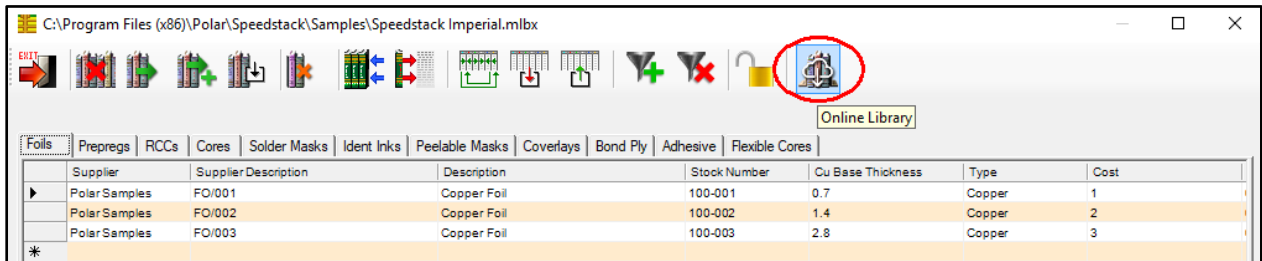

Speedstack connects to the Polar Online Library and displays the materials available for each file type from all the suppliers in the Speedstack Supplier Partner program; click on a material supplier's name in the Filter by Supplier pane to view just the materials available from that supplier.

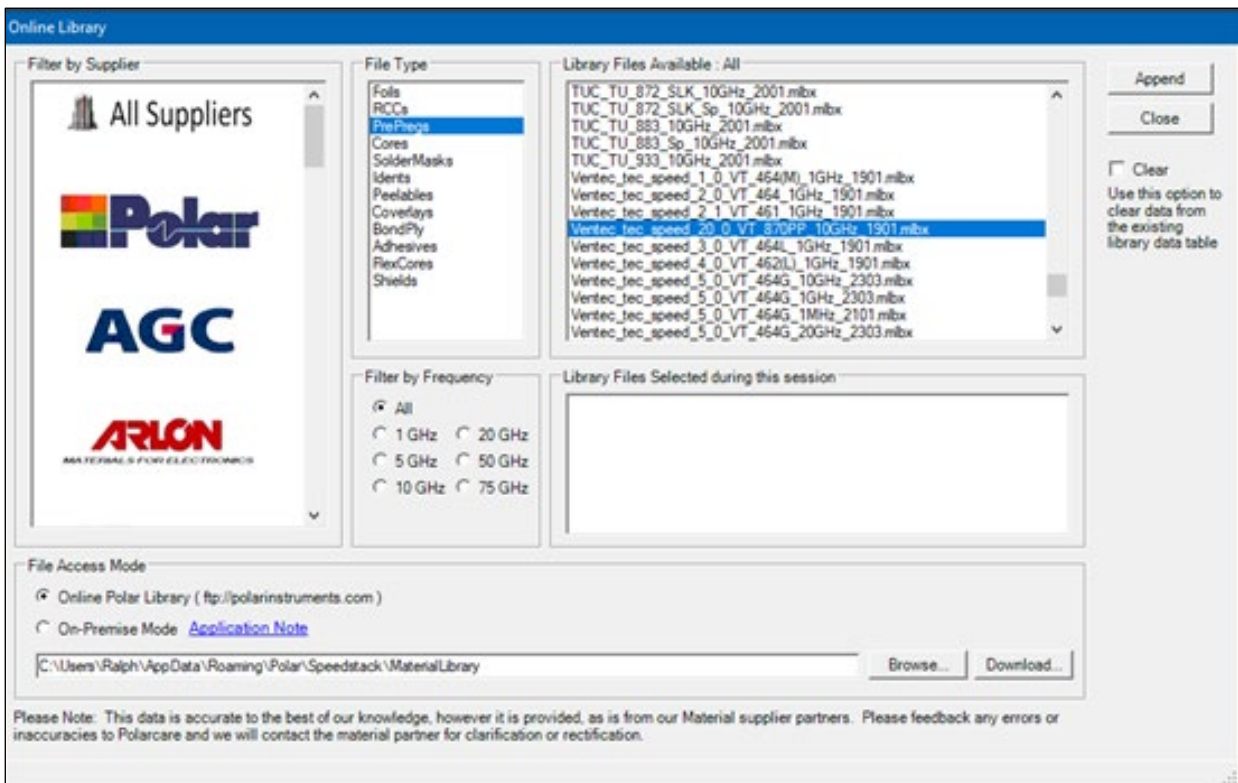

Filtering libraries by frequency

Material libraries contain values for dielectric constant (Dk) and loss tangent (Df) measured at frequencies specified by the supplier. The measurement frequency is indicated in the library file name. Use the Filter by Frequency function to list all files or just the files with Dk and Df specified at the chosen frequency. Speedstack provides frequency filtering at 1GHz, 5GHz, 10GHz, 20GHz, 50GHz and 75GHz.

On-Premise libraries

To download a copy of the online library to a local folder, click the Download... button. The library will be downloaded and saved by default to the following local folder:

C:\Users\username\AppData\Roaming\Polar\Speedstack\MaterialLibrary

Where access to the online library is unavailable or a local copy is required, a complete set of the online libraries is available on request to Polarcare subscribers; contact polarcare@polarinstruments.com with your Polarcare contract number and Speedstack version. The supplied libraries should be copied to a suitable local folder with the file/folder structure preserved. To use the on-premise library, choose On-Premise Mode and browse to the local copy: the library files should appear as a local online library; import materials as described above.

Downloadable mlbx files

Note that the Online Library only lists files with .mlbx extensions and that follow the file naming convention:

<Supplier>_<MaterialFamily>_<frequency>_<release>.mlbx
(No spaces are permitted in downloadable library file names.)

All .mlbx file names reflect the frequency at which dielectric constant and loss tangent is specified and the Speedstack release version.

Although the .mlbx file format will support multiple material types (Foil, Prepregs, Cores, etc.) in the same file *the downloadable .mlbx file only contains a single material type.*

Choosing material files

Browse through the list of available materials or scroll through the list of suppliers and choose a supplier to filter the materials by that supplier.

Choose the File Type and material. From the Existing Data Table dialog select Append to add the new materials to the table. Click the Clear checkbox to replace the contents of the selected table type. Repeat for each material to be added to the library then click Close.

Using proxy servers

Note: Many organisations connect to the Internet via proxy servers to provide caching and controlled access. In some cases, a proxy server may return library content in a format that prevents successful download into Speedstack. If your organisation connects to the internet via a proxy server, you may need to request the MIS department to grant address <ftp://polarinstruments.com> permission to bypass the proxy server – if this is not possible the libraries can be supplied for local (on-premise) access (see above.)

Printing stackup information

To print the stackup information, from the File menu choose the Print Technical Report command to open the Speedstack Report Printer.

Print Technical Report includes:

- Stack data columns
- Controlled impedance structure data columns
- Drill data columns
- Bill of Material data columns
- Frequency dependent loss graphs for each structure

along with frequency dependent properties and information entered into the Stack File Properties.

CONFIDENTIAL

C:\Program Files (x86)\Polar\Speedstack\Samples\Eval Imperial.sci Units: Mils

Layer	Stack up	Description	Copper Layer Type	Base Thickness	Processed Thickness	Resin Content	εr
1	M-5683 L1	Liquid Photoimageable Mask		1.000	1.400		4.000
2		Copper Foil	Signal	0.700	1.400		
3		PrePreg 1080	Signal	3.000	1.350	60.000	4.200
4		FR4 Core	Signal	3.000	3.000	60.000	4.200
5		PrePreg 3080	Plane	1.400	1.400		
6		PrePreg 1551	Signal	6.000	2.776	60.000	4.200
7		PrePreg 1551	Signal	6.000	5.552	47.000	4.200
8		PrePreg 1551	Signal	6.000	5.552	47.000	4.200
9		FR4 Core	Signal	1.400	1.400	46.000	4.200
10		FR4 Core	Signal	12.000	12.000	46.000	4.200
11		PrePreg 1551	Signal	6.000	5.552	47.000	4.200
12		PrePreg 1551	Signal	6.000	5.552	47.000	4.200
13		PrePreg 3080	Plane	3.000	2.776	60.000	4.200
14		FR4 Core	Plane	1.400	1.400		
15		FR4 Core	Signal	3.000	3.000	60.000	4.200
16		PrePreg 1080	Signal	1.400	1.400		
17		PrePreg 1080	Signal	3.000	1.350	60.000	4.200
18		Copper Foil	Signal	0.700	1.400		
19		Liquid Photoimageable Mask		1.000	1.000		4.000

Copper Thickness = 11.200 | Dielectric Thickness = 49.660 | Solder Mask Thickness = 2.000 |
 Stack Up Thickness = 60.860 | Stack Up Thickness with Soldermask = 62.860
 Stack Up Cost = 54.00

Structure Image	Structure Name	Target Impedance	Calculated Impedance	Lower Trace Width (W1)	Upper Trace Width (W2)	Trace Thickness (T1)	Substrate 1 Height (H1)	Substrate 2 Height (H2)	Ref. Plane 1 in Layer	Ref. Plane 2 in Layer	Coating Above Substrate (C1)
	Coated Microstrip 1B	75.000	75.740	4.000	3.000	1.400	6.350	0.000	3	0	1.000
	Edge Coupled Coated Microstrip 1B	100.000	100.290	7.650	6.650	1.400	6.350	0.000	3	0	1.000
	Edge Coupled Offset Stripline 1B1A	100.000	101.280	7.250	6.250	1.400	27.280	15.280	3	6	0.000

StackName: I/O Control	Associated Documents:	Revision:	Modification:	Date of Revision:	Editor
Drawing No: 1153		1.01		4/1/2022	NJM
Date: 01/08/2022		1.02		4/4/2022	CEM
Designer: RRB		1.03		1/8/2022	RRB
Department: Eng Model					
Office: Garenne Park					

Copyright © Polar Instruments Ltd

Speedstack Technical Report

Speedstack Report Printer toolbar

The Speedstack Report Printer toolbar provides shortcut access to the most commonly used printing commands.

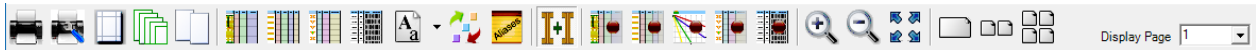

Use these commands to set up the printer, page orientation and margins, font size and printing order, select data columns for display, display or suppress data tables and choose the on-screen zoom levels. Button functions are described below.



Send report to printer



Print set up – choose printer, print range, copies



Page set up – orientation and margins



Print all pages



Print range of pages (display Page Range dialog)

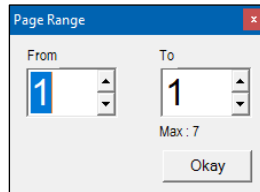

Select page range



Select stack data columns



Select impedance data columns



Select drill data columns



Select BOM data columns





Change font size



Select stack/drills/impedance/notes print order





Set note field aliases

  Show expanded drills – toggle wide stack and narrow stack image

 Toggle suppress stack data table

 Toggle suppress controlled impedance data table



 Toggle suppress frequency dependent loss graphs

 Toggle suppress drill data table

 Toggle suppress BOM data table

  Zoom in / Zoom out

 Fit page to viewer

   Preview one / two / four pages

 Display Page 1 Select page for display

Speedstack Report Printer menu system

File menu

Use the File menu under the Printing window to save and load print settings.

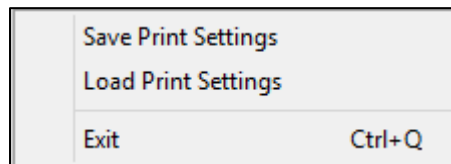

Saving print settings

Click Save Print Settings and specify the Print Settings file name and location.

Loading saved print settings

Click Load Print Settings to load a saved Print Settings file. Whichever settings were last used in a session will become the default when the Printing window is next loaded.

Options menu

The Speedstack Report Printer Options menu contains all the settings for printing.

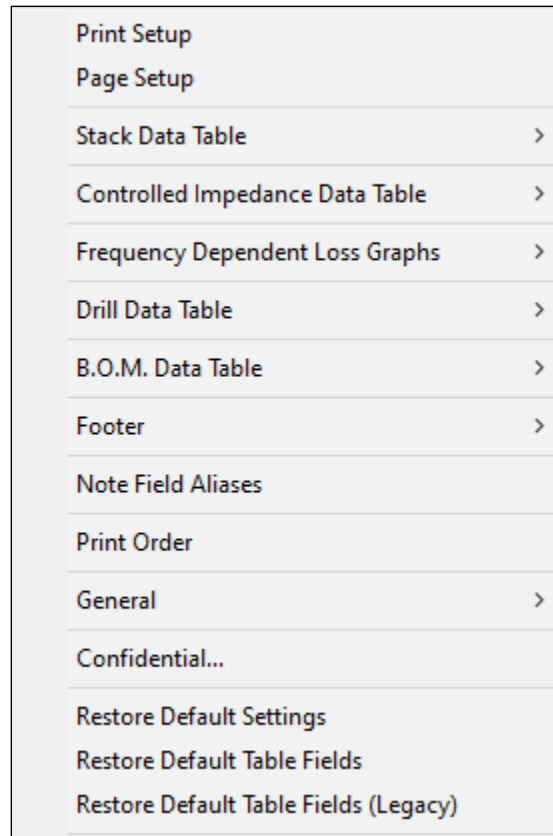

Print Setup

Use the Print Setup command to choose the target printer, along with its properties, the range of pages to print and number of copies. Optionally, click the Print to file check box to save the output to a file (for example, to save the file as a document in PDF format) when printed.

Page Setup

Page Setup displays the Page Setup dialog to change the paper size and source and page orientation and margins.

Stack Data Table

The Stack Data Table commands allow for optional display of stack parameters, drills, thickness totals and tolerances.

Choose Stack Data Table, Suppress to hide the stack data table and the associated columns selected for display via the Stack Data Columns... command.

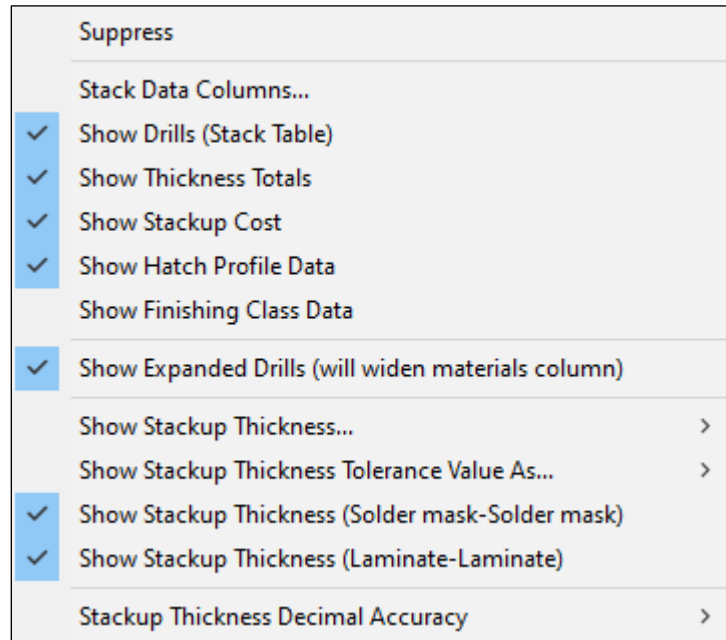

Stack Data Columns...

Choose Stack Data Columns... to select and order the data columns available for the stack as required.

Select a column from the Available Columns list, move it to the Selected Columns list and use the Up and Down buttons to order the displayed columns.

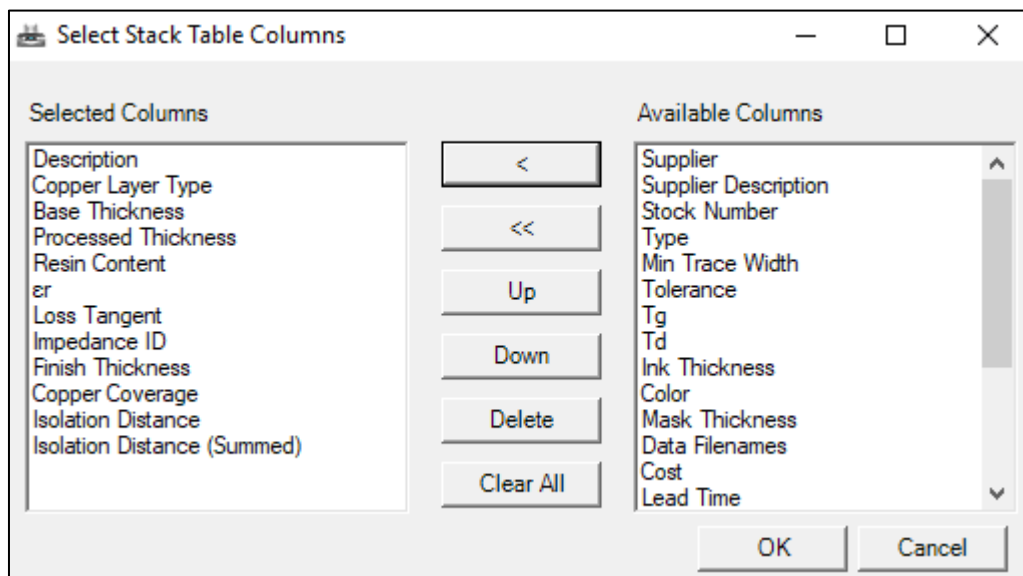

The stack data table is displayed in selected column order:

Layer	Stack up	Description	Copper Layer Type	Base Thickness	Processed Thickness	Resin Content	εr	Loss Tangent	Impedance ID	Finish Thickness	Copper Coverage	Isolation Distance	Isolation Distance (Summed)
		Liquid Photolamageable Mask		25.400			4.000	0.0195					
1		Copper Foil	Signal	17.780	17.780				1.2	17.780	0.000		
		PrePreg 1080		76.200	49.530	60.000	4.200	0.0195		76.200	0.000	49.530	49.530
2		FR4 Core	Signal	35.560	35.560					35.560	0.000		
		PrePreg 1651		76.200	76.200	60.000	4.200	0.0195		76.200	0.000	76.200	76.200
3		FR4 Core	Plane	35.560	35.560					35.560	0.000		
		PrePreg 3080		76.200	70.510	60.000	4.200	0.0195		76.200	0.000	70.510	352.552
		PrePreg 1651		152.400	141.021	47.000	4.200	0.0195		152.400	0.000	141.021	-
		PrePreg 1651		152.400	141.021	47.000	4.200	0.0195		152.400	0.000	141.021	-
4		FR4 Core	Signal	35.560	35.560				3	35.560	0.000		
		PrePreg 1651		152.400	141.021	47.000	4.200	0.0195		152.400	0.000	141.021	352.552
		PrePreg 1651		152.400	141.021	47.000	4.200	0.0195		152.400	0.000	141.021	-
		PrePreg 3080		76.200	70.510	60.000	4.200	0.0195		76.200	0.000	70.510	-
5		FR4 Core	Plane	35.560	35.560					35.560	0.000		
		PrePreg 1651		152.400	141.021	47.000	4.200	0.0195		152.400	0.000	141.021	352.552
		PrePreg 1651		152.400	141.021	47.000	4.200	0.0195		152.400	0.000	141.021	-
		PrePreg 3080		76.200	70.510	60.000	4.200	0.0195		76.200	0.000	70.510	-
6		FR4 Core	Signal	76.200	76.200	60.000	4.200	0.0195		76.200	0.000	76.200	76.200
		PrePreg 1080		76.200	49.530	60.000	4.200	0.0195		76.200	0.000	49.530	49.530
7		Copper Foil	Signal	17.780	17.780				4	17.780	0.000		
8		Liquid Photolamageable Mask		25.400			4.000	0.0195					

Copper Thickness = 248.920 | Dielectric Thickness = 1261.364 | Solder Mask Thickness = 50.800 | Stack Up Thickness = 1510.284 | Stack Up Thickness with Soldermask = 1561.084
Stack Up Cost = 34.80

Use the Show Drills (Stack Table) command to show or hide the drills in the stackup graphic in the Stack Table.

The Thickness Totals provides optional display of the sum of materials thicknesses, copper, dielectric, solder mask and the stackup – with and without the solder mask thickness.

Copper Thickness = 284.480 | Dielectric Thickness = 1261.364 | Solder Mask Thickness = 50.800
Stack Up Thickness = 1545.844 | Stack Up Thickness with Soldermask = 1596.644

Use the Show Stackup Cost option to display the cost in the stack summary.

Select Show Hatch Profile Data to include the hatch pitch and width and copper area percentage in the stack summary.

The Show Finishing Class Data displays the copper finishing class specified from the list of Copper Finishing classes – either a Copper Coverage Fishing Class or a Simple Percentage Finishing Class – depending on which finishing method was chosen via the Tools\Set Finishing Method.

Show Expanded Drills

By default, the Stack Data Table shows just the first six drill slots in the stack (Stackup Columns in the Add Drill dialog), although up to eleven drill slots may have been defined. Use Show Expanded Drills to view all defined drill slots.

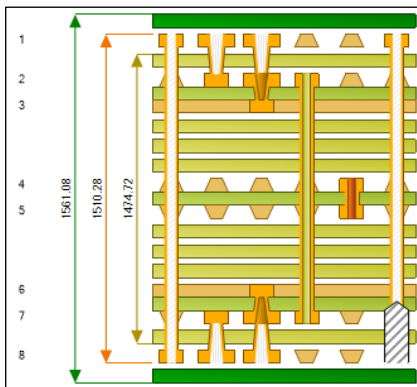

Standard Drill display

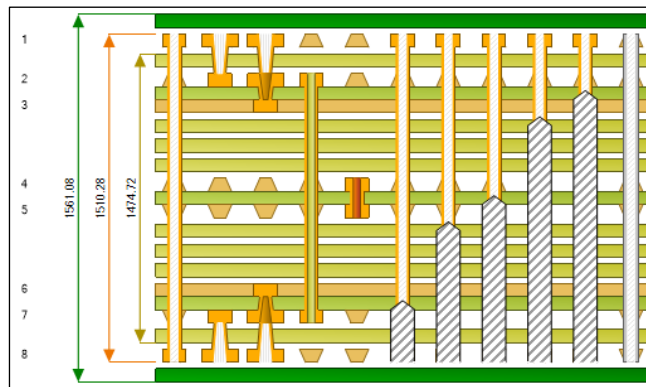

Expanded Drill display

Use the Show Stackup Thickness commands to display or hide the target or calculated values of total stack thickness.

Values can optionally include solder mask and laminate thicknesses.

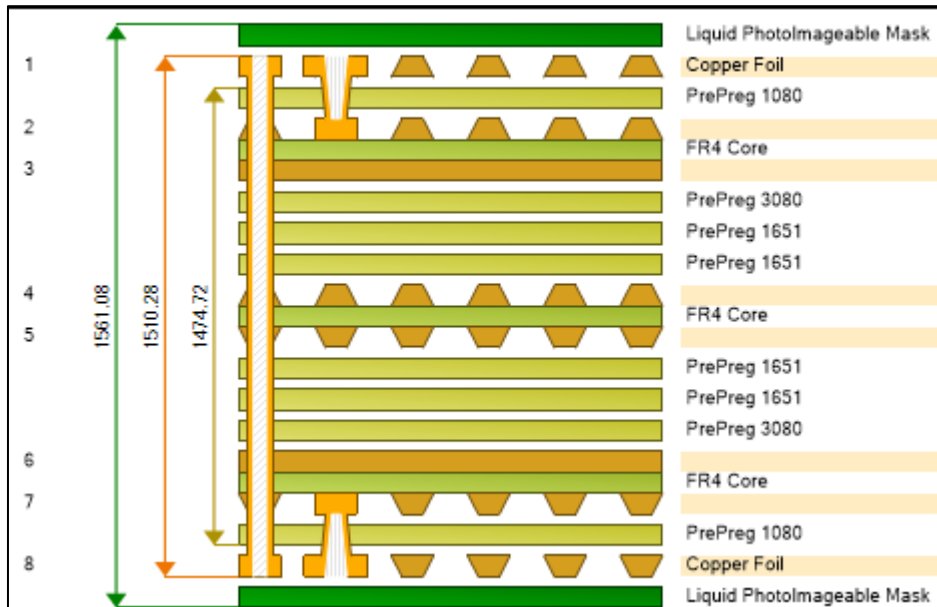

When the target value of the Stackup thickness is chosen the Stackup Thickness Tolerance values can be displayed as percentages of the target stack thickness or as actual values. Choose Stackup Thickness Accuracy to display accuracy by number of decimal places.

Controlled Impedance Data Table

Use the Controlled Impedance Data Table options to show or hide the controlled impedance structures and parameters.

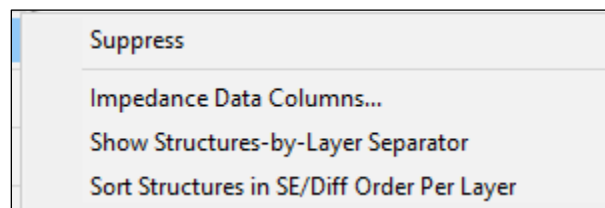

Impedance Data columns can be selected for display and ordered as required.

Controlled Impedance data columns

Choose the parameters for display from the Available Columns pane and change the order of display using the Up and Down buttons.



More Calculations

Note that the available data columns include the results shown in the Controlled Impedance Toolbar | More Calculations dialogs. The More Calculations results are highlighted in red in the graphic below

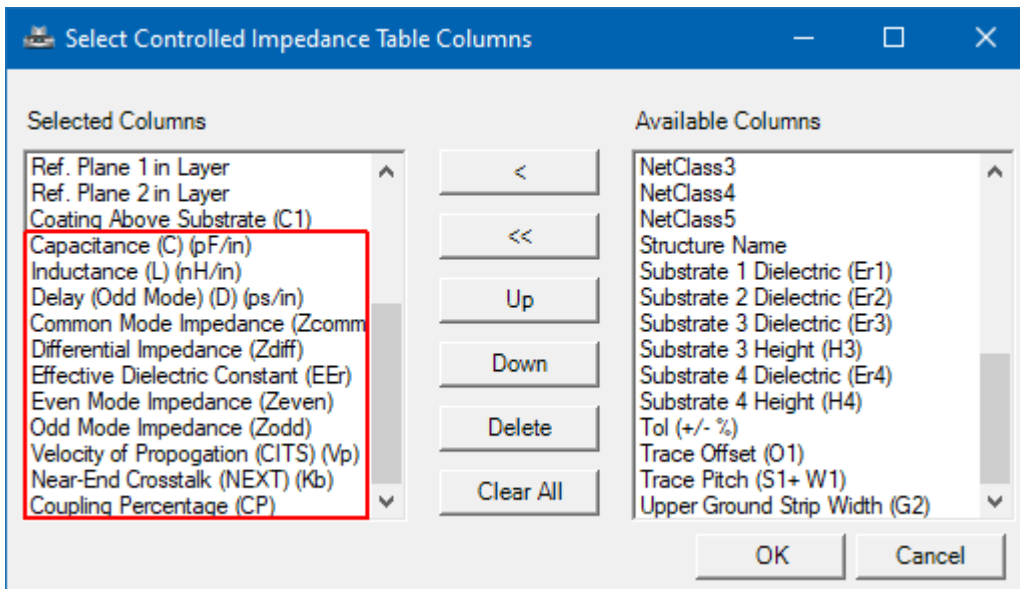

The selected columns are added to the Impedance Table. Note that adding or removing columns for display will initiate a full on-demand recalculation of results.

Structure Image	Target Impedance	Calculated Impedance	Lower Trace Width (W1)	Upper Trace Width (W2)	Trace Thickness (T1)	Trace Separation (S1)	Substrate 1 Height (H1)	Substrate 2 Height (H2)	Ref. Plane 1 in Layer	Ref. Plane 2 in Layer	Coating Above Substrate (C1)	Delay (Odd Mode) (D) (ps/in)	Common Mode Impedance (Zcommon)	Differential Impedance (Zdiff)	Effective Dielectric Constant (EEr)	Even Mode Impedance (Zeven)	Odd Mode Impedance (Zodd)	Velocity of Propagation (CITS) (Vp)	Near-End Crosstalk (NEXT) (Kb)	Coupling Percentage (CP)
	75.000	75.740	4.000	3.000	1.400	0.000	6.350	0.000	3	0	1.000	0.000	0.000	0.000	3.230	0.000	0.000	0.556	0.0000E+00	0.000
	100.000	100.290	7.650	6.650	1.400	8.115	6.350	0.000	3	0	1.000	147.683	33.543	100.289	3.038	67.086	50.144	0.574	7.2257E-02	7.226
	100.000	100.060	8.335	8.217	1.400	11.350	6.350	0.000	3	0	1.000	148.439	30.622	100.055	3.070	61.244	50.028	0.571	5.0402E-02	5.040

Grouping structures by layer





Within the Impedance Data Table structures can be grouped by layer; choose Show Structures-By-Layer Separator. The Separator will add a black structure separator bar on the print out between structure groups, allowing the structures to be sorted by layer number rather than the order that the structures are added to the stack.

Structure Image	Structure Name	Target Impedance	Calculated Impedance	Lower Trace Width (W1)	Upper Trace Width (W2)	Trace Thickness (T1)	Substrate 1 Height (H1)	Substrate 2 Height (H2)	Ref. Plane 1 in Layer	Ref. Plane 2 in Layer	Coating Above Substrate (C1)
	Coated Microstrip 1B	75.000	75.870	114.300	88.900	17.780	161.290	0.000	3	0	25.400
	Edge Coupled Coated Microstrip 1B	100.000	100.350	215.900	190.500	17.780	161.290	0.000	3	0	25.400
	Edge Coupled Offset Stripline 1B1A	100.000	101.280	184.150	158.750	35.560	692.912	388.112	3	6	0.000
	Coated Microstrip 1B	75.000	75.870	114.300	88.900	17.780	161.290	0.000	6	0	25.400

Sorting impedance structures by type





The technical report, by default, prints the structures within a layer in the order in which they were added to the stack.

In the example stack below the structures were added to the stack in the order shown.

Impedance ID	Structure Image	Structure Name	Impedance Signal Layer	Ref. Plane 1 in Layer	Ref. Plane 2 in Layer	Lower Trace Width (W1)	Upper Trace Width (W2)	Trace Separation (S1)	Target Impedance	Tol (+/- %)	Calculated Impedance
1		Edge Coupled Coated Microstrip 1B	1	3	0	8.500	7.500	8.115	100.000	10.000	100.350
2		Coated Microstrip 1B	1	3	0	4.500	3.500	0.000	75.000	10.000	75.870
3		Coated Microstrip 1B	1	3	0	11.476	10.476	0.000	50.000	10.000	49.520
4		Edge Coupled Coated Microstrip 1B	1	3	0	12.542	11.542	10.000	85.000	10.000	85.220

Structures within each layer can be grouped by type, single ended and differential.

To sort the structures by type choose the Sort Structures by SE/Diff Order per Layer; the structures within each layer will be ordered in single ended then differential order as shown in the graphic below.

Impedance ID	Structure Image	Structure Name	Impedance Signal Layer	Ref. Plane 1 in Layer	Ref. Plane 2 in Layer	Lower Trace Width (W1)	Upper Trace Width (W2)	Trace Separation (S1)	Target Impedance	Tol (+/- %)	Calculated Impedance
2		Coated Microstrip 1B	1	3	0	4.500	3.500	0.000	75.000	10.000	75.870
3		Coated Microstrip 1B	1	3	0	11.476	10.476	0.000	50.000	10.000	49.520
1		Edge Coupled Coated Microstrip 1B	1	3	0	8.500	7.500	8.115	100.000	10.000	100.350
4		Edge Coupled Coated Microstrip 1B	1	3	0	12.542	11.542	10.000	85.000	10.000	85.220

Frequency dependent loss graphs

Speedstack Si provides graphing and tabular display of the frequency dependent properties of each controlled impedance structure in the stackup. The technical report includes the option of displaying the loss v frequency graph of every structure in the stackup – see below.

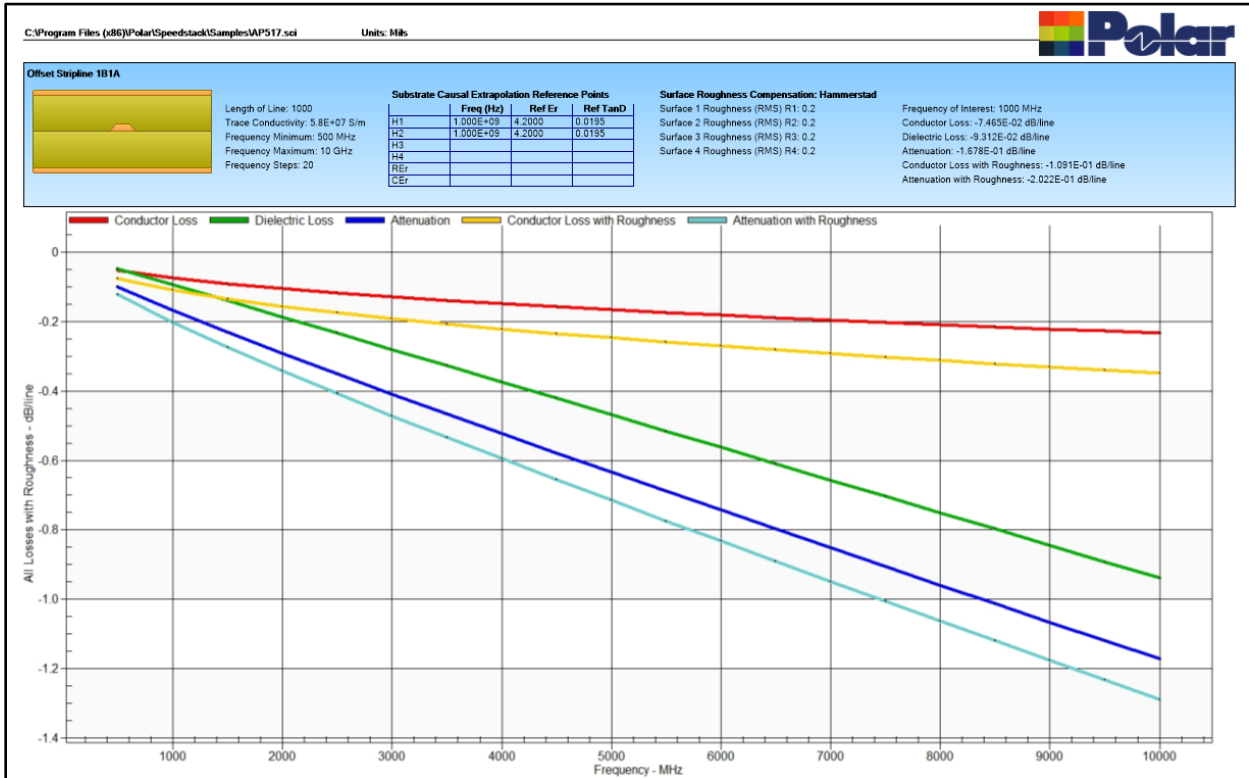

When the technical report is selected for print Speedstack recalculates and displays the loss v frequency for the frequency dependent properties of each structure in the stackup.

The display for each structure includes the structure graphic and the associated frequency dependent parameters, the substrate causal extrapolation reference points, the surface roughness method and settings and the losses and attenuation at the user defined frequency of interest.

From the Options menu, choose Frequency Dependent Loss Graphs|Suppress to toggle display of frequency dependent loss graphs and tables.

Drill Data Table

The drill information is reflected in the Technical Report.

From the File menu choose Print Technical Report.

The Technical Report opens with the Stack Data Table which includes the drill and back drill information

Showing expanded drills



Show Expanded Drills



Speedstack can display up to eleven drill columns in a stack though six columns are often sufficient. Use Show Expanded Drills to toggle between wide stack and narrow stack image mode. Selecting the narrow stackup image frees up the horizontal space for more data columns. Speedstack displays a warning if drills exist beyond column six and narrow stack mode is selected,

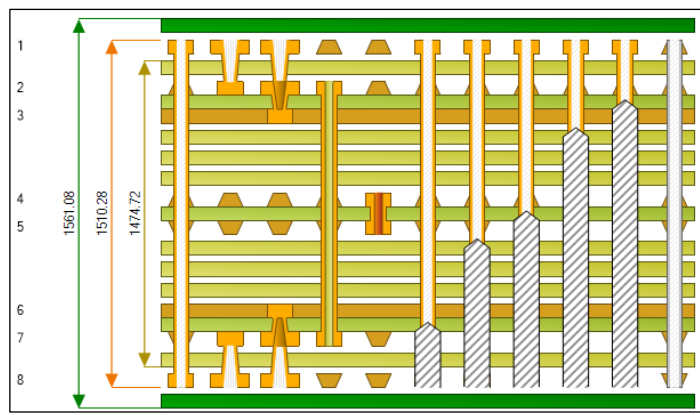
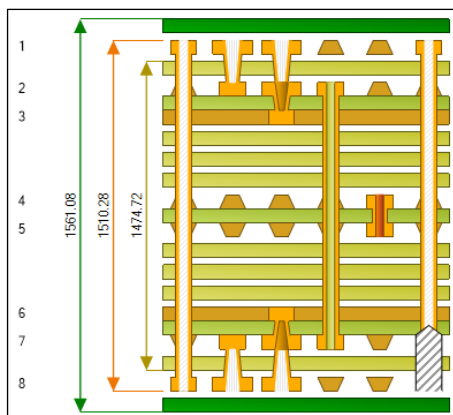

Example 1

The example below contains a single drill and associated back drill.

Layer	Stack up	Description	Copper Layer Type	Base Thickness	Processed Thickness	Resin Content	κr
1		Liquid PhotoImageable Mask			25.400		4.000
		Copper Foil	Signal	17.780	35.560		
2		PrePreg 3113		101.600	100.711	53.000	4.200
		PrePreg 3113		101.600	100.711	53.000	4.200
3		FR4 Core	Signal	35.560	35.560	45.000	4.200
		FR4 Core	Plane	35.560	35.560	45.000	4.200
4		PrePreg 3113		101.600	87.376	53.000	4.200
		PrePreg 3113		101.600	87.376	53.000	4.200
5		FR4 Core	Signal	35.560	35.560	45.000	4.200
		FR4 Core	Signal	203.200	203.200	45.000	4.200
6		PrePreg 3113		101.600	87.376	53.000	4.200
		PrePreg 3113		101.600	87.376	53.000	4.200
7		FR4 Core	Plane	35.560	35.560		
		FR4 Core	Signal	203.200	203.200	45.000	4.200
8		PrePreg 3113		101.600	100.711	53.000	4.200
		PrePreg 3113		101.600	100.711	53.000	4.200
		Copper Foil	Signal	17.780	35.560		
		Liquid PhotoImageable Mask			25.400		4.000

Copper Thickness = 284.480 | Dielectric Thickness = 1361.948 | Solder Mask Thickness = 50.800 | Stack Up Thickness = 1646.428 | Stack Up Thickness with Soldermask = 1697.228
Stack Up Cost = 77.00
Simple Percentage Finishing Class: 'Class 1' = 17.780

Select page 2 to display the Drill Data Table.

Use the Drill Data Table command to show or hide the table of drill parameters and to select and order parameter values for display.

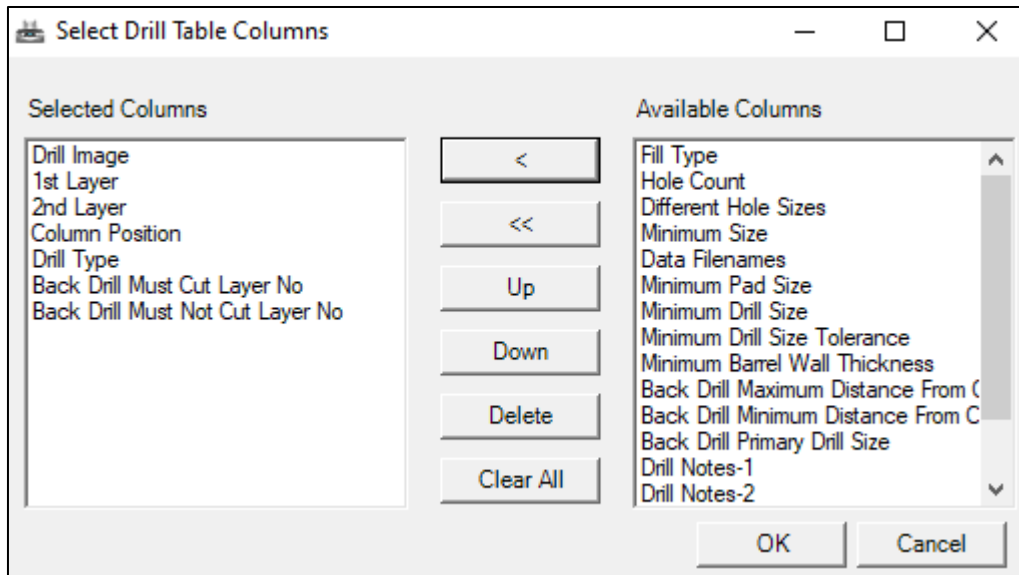

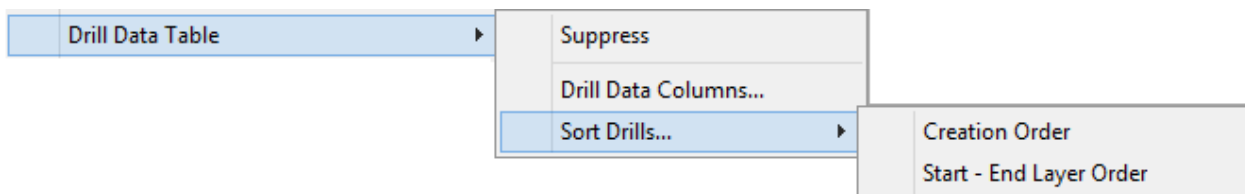

Click items in the Available Columns list and add to the Selected Columns list for display. Use the Up and Down arrows to order/reorder the selected columns.

Use the Sort Drills... command to order the drill table – drills can be sorted by start-end layer order or creation order.



Displaying the Drill Data Table

Page 2 of the Technical Report displays the Drill Data Table

Drill Image	1st Layer	2nd Layer	Column Position	Drill Type	Must-Cut Layer No	Must-Not-Cut Layer No
	1	5	3	Mechanical PTH	-	-
	8	-	3	Back Drill	6	5

The Drill Data Table displays the chosen Drill Data Table columns in the sorted order

Example 2

The example stackup below contains a selection of drill and back drill types.





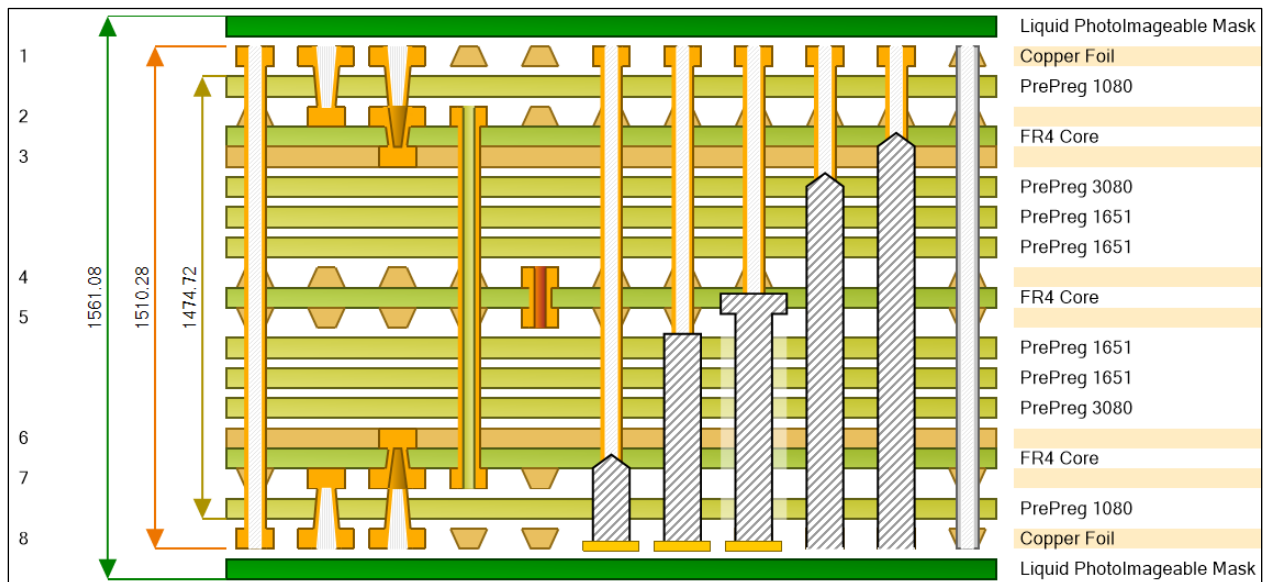





These are reflected in the Technical Report
(File | Print Technical Report)









Displaying the Drill Data Table

Page down through the Technical Report to display the Drill Data Table

Drill Image	1st Layer	2nd Layer	Column Position	Drill Type	Must-Cut Layer No	Must-Not-Cut Layer No	Back Drill Type	First Layer Capped	Calculated Drill Depth - Back Drill Must-Cut	Calculated Drill Depth - Back Drill Must-Not-Cut
	7	6	3	Laser PTH	-	-	-	False	0.000	0.000
	8	-	10	Back Drill	3	2	POINTED	False	1331.214	1442.974
	8	-	9	Back Drill	4	3	POINTED	False	943.102	1331.214
	8	-	8	Back Drill	5	4	ROUTER	True	602.742	943.102
	8	-	7	Back Drill	6	5	FLAT	True	214.630	602.742
	8	-	6	Back Drill	7	6	POINTED	True	102.870	214.630
	8	7	2	Laser PTH	-	-	-	False	0.000	0.000
	8	7	3	Laser PTH	-	-	-	False	0.000	0.000

Bill of Materials Table

Speedstack's Technical Report incorporates the Bill of Material (BOM) table with the stock-number displayed optionally as a barcode. The table contains fields for Total Quantity (No. Panels * Stack Quantity) and Total Cost (Unit Cost * Total Quantity.)

Supplier	Supplier Description	Description	Type	Stock Number	Stack Quantity	Unit Cost	Stack Cost	Total Quantity	Total Cost
Polar Samples	SM/001	Liquid Photolimageable Mask	SolderMask		2	0.00	0.00	2	0.00
Polar Samples	FO/001	Copper Foil	Copper		2	1.00	2.00	2	2.00
Polar Samples	PP/001	PrePreg 1080	Dielectric		2	1.00	2.00	2	2.00
Polar Samples	CO/005	FR4 Core	FR4		2	5.00	10.00	2	10.00
Polar Samples	PP/002	PrePreg 3080	Dielectric		2	2.00	4.00	2	4.00
Polar Samples	PP/004	PrePreg 1651	Dielectric		4	4.00	16.00	4	16.00
Polar Samples	CO/020	FR4 Core	FR4		1	20.00	20.00	1	20.00
							54.00	54.00	

No. of Panels = 1 | Circuits Per Panel = 1 | Price Per Circuit = 54.00 |

The table includes totals for the Stack Cost and the Total Cost columns.

A summary section presents 3 values: No. of Panels, Circuits Per Panel and Price Per Circuit. The No. of Panels and Circuits Per Panel can be entered by the user at any time or optionally at the start of each print session.

Bill of Materials Table columns can be selected for display and ordered as required. Choose the parameters for display from the Available Columns pane and change the order of display using the Up and Down buttons.

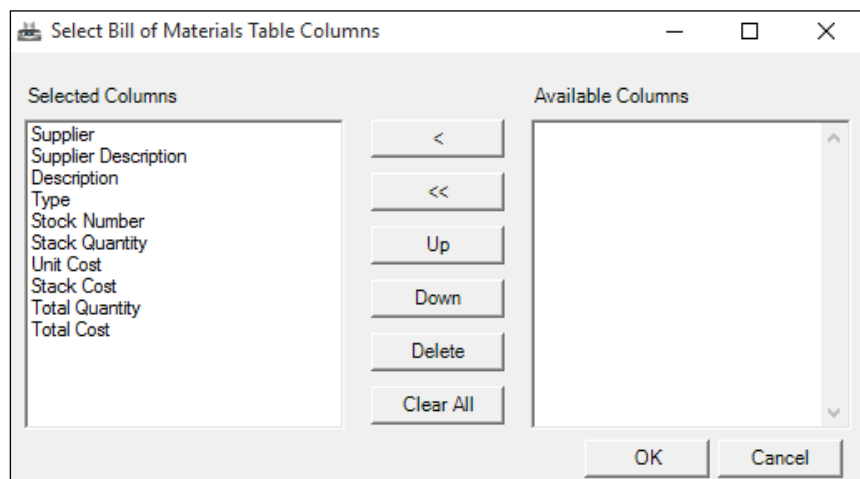







From the Options menu choose B.O.M. Data Table to display or suppress the table. The Suppress command toggles the B.O.M. table on and off in the report.

Stock numbers

Stock numbers can be displayed in alpha-numeric form or as barcodes.

B.O.M. Data Table >	Suppress	
Footer >	Stock Number >	Show as Barcode
Note Field Aliases	Panels / Circuits per Panel...	Barcode Font and Start/Stop Character...
Print Order	✓ Show Number of Panels	
General >	✓ Show Circuits Per Panel	
	✓ Show Price Per Circuit	

Choose Stock Number|Show as Barcode to toggle the Stock Number display between barcodes or alpha-numeric text.

Description	Type	Stock Number	Stack Quantity	Unit Cost
Liquid PhotoImageable Mask	SolderMask		2	0.00
Copper Foil	Copper		2	1.00
PrePreg 1080	Dielectric		2	1.00
FR4 Core	FR4		2	5.00
PrePreg 3080	Dielectric		2	2.00
PrePreg 1651	Dielectric		4	4.00
FR4 Core	FR4		1	20.00

Choosing the bar code font

From the Stock Number command choose Barcode Font and Start/Stop Character. The Select Barcode font and Start/Stop Marker Characters dialog is displayed.

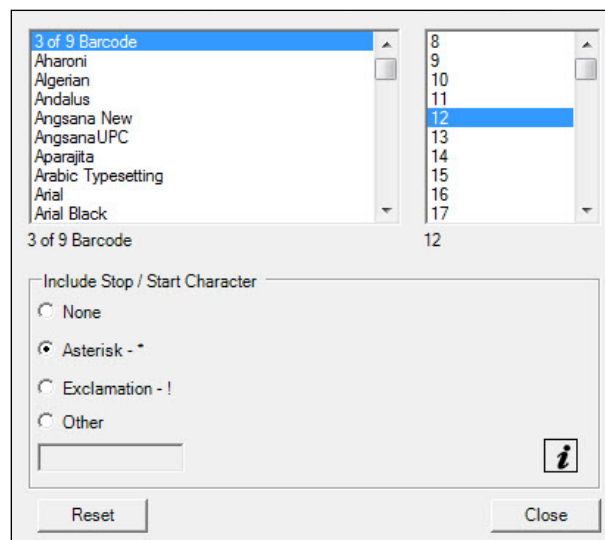

Choose the font and font size and the start / stop character as appropriate. (The barcode font must already be installed on the host computer.)

Choosing the start/stop character

The Start/Stop character is a requirement for certain barcode types such as Code 39 (also referred to as Code 3 of 9, Code 3/9, Type 39, etc.) The Code 39 asterisk character is normally reserved as a start/stop character rendering the data a valid barcode.

As an example, if the Stock-Number is 123-456, selecting the Asterisk option will add enclosing asterisks to the Stock-Number so that the barcode is valid.

(In some instances, asterisks may already be included in the Stock-Number in which case choose the None option.)

There are other situations where another character may be used. Exercise caution when determining the appropriate font choice and start/stop character to use. In the event that an inappropriate font is chosen, the results may be unpredictable.

Panels / Circuits per Panel...

To specify the number of panels and circuits per panel, from the Options menu choose

B.O.M. Data Table | Panels / Circuits per Panel...

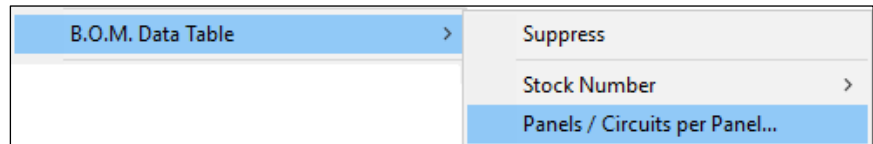

Enter the number of panels and the number of circuits per panel.

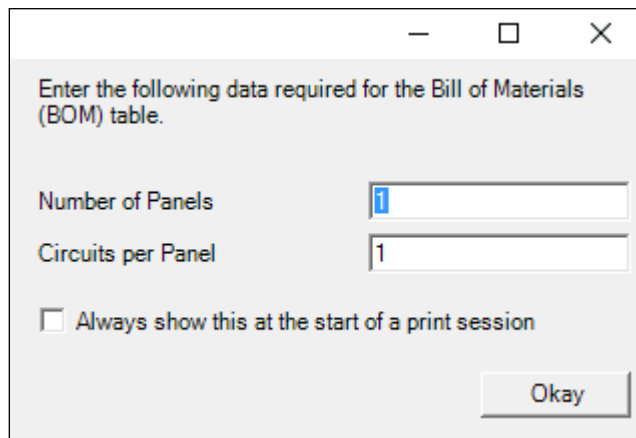

The summary Price Per Circuit is then a calculated value (Total Stack Cost / Circuits Per Panel).

No. of Panels = 1 | Circuits Per Panel = 1 | Price Per Circuit = 54.00

Use the Show Number of Panels, Show Circuits per Panel and Show Price per Circuit commands to toggle the display of the associated summary components.

Footer

The report footer section is an optional item and may be displayed or suppressed (hidden).

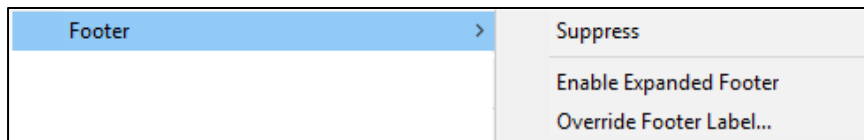

Suppressing the footer

When the Footer section is suppressed the space is used for other data, often reducing the number of pages required for the technical report.

StackName: M-Board	Version: V19.05	Revision:	Modification:	Date of Revision:	Editor:	Page 1/X
Date: 12 June 2019	Associated Documents:	Rev #1	Coll	1 Dec 2018	JB	
Author: B Johnson		Rev #2	Data Net	1 Apr 2019	JB	
Department: Eng						
Site: North Side						

Using the expanded footer

Use the Expanded Footer option to allow longer and more descriptive stack names to be displayed.

StackName: Controller M-Board MWPD1636		Revision:	Modification:	Date of Revision:
Version: V19.05	Associated Documents:	Rev #1	Coll	1 Dec 2018
Date: 12 June 2019		Rev #2	Data Net	1 Apr 2019
Author: B Johnson				
Department: Eng				
Site: North Side				

Overriding the footer labels

The labels in the footer may be changed to reflect the stackup design workflow and organisational structure.

Choose Footer | Override Footer Label...

The Override Footer Labels dialog is displayed:

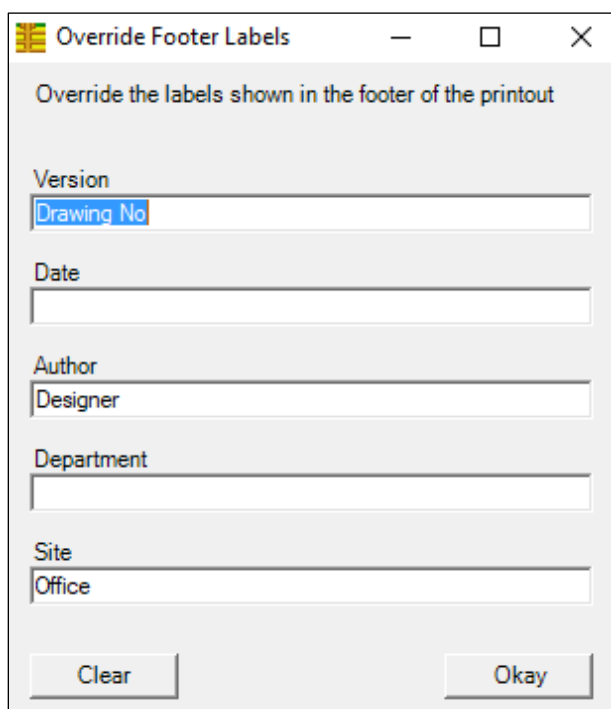

The new labels will be reflected in the footer:

StackName:	Controller M-Board MWPD1636
Drawing No:	19.05
Date:	12 June 2019
Designer:	B Johnson
Department:	Eng
Office:	North Side

Note Field Aliases

Note Field Aliases allows for the free-text note fields (for the Stack and Controlled impedance tables) to be given descriptive names.

Print Order

Use the Print Order dialog to move the Controlled Impedance Table, Drill Tables and Notes sections up or down within the report.

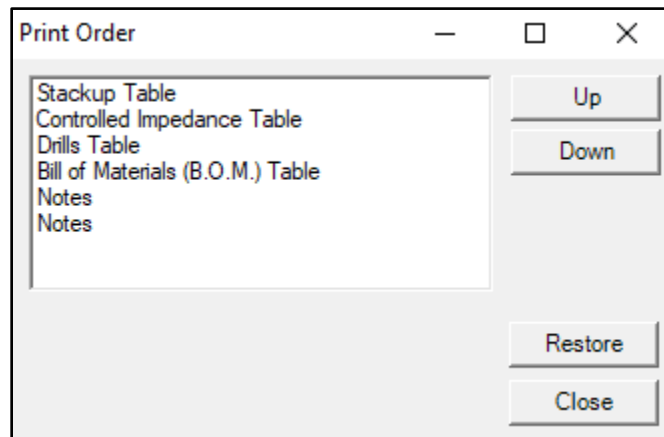

Note: the Stack/Materials data Table cannot be reordered and must remain the first item in the print order.

General Options

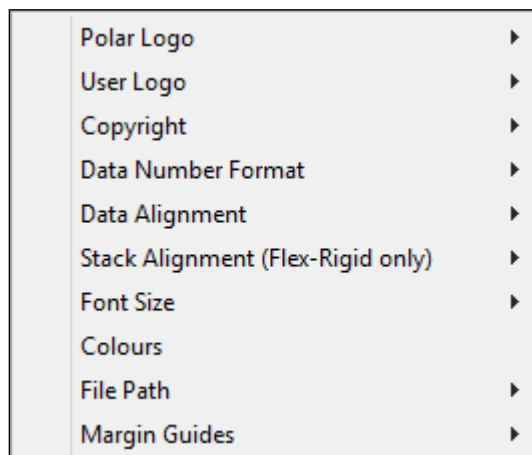

The General Options are described below

Polar Logo

Polar Logo: toggles the Polar Instruments logo on and off.

User Logo: toggles the user-defined logo on and off (as set in the application configuration).

Copyright

Copyright: toggles the copyright information on and off and allows copyright text to be edited.

Data Number Format

Data Number Format: sets the precision of numeric data in the printout.

Data Alignment

Data Alignment: specifies alignment (left, centre, etc.) for stack, impedance and drill data.

Stack Alignment

Stack Alignment (Flex-Rigid only): – Align to Master Stack allows the vertical position of sub-stacks (printed on separate pages within the report) to be preserved with respect to the master stack; Align to Page Top presents each sub-stack at the top of each page.

Colours

Colours: allows for the colours of items within the report to be customised. Click Override Default Colours and Change to specify the new colour. Click Reset All to return to the default colours.

File Path

File Path: toggles on and off the file path/file name

Margin Guides: toggles on and off boundary markings (in the user selected units.) These match the Speedstack units selected within the Stackup Editor | Units menu.

Margin Guides

The margin guides allow for display of the printable area of the page – which can vary depending upon the device – even though the page size remains the same. (With some devices the report cannot use the full extents of the page.)

Confidential... notice

The Technical Report includes an optional Confidential notice to be added to the report.

Click Confidential... the Confidential Stamp Options dialog is displayed.

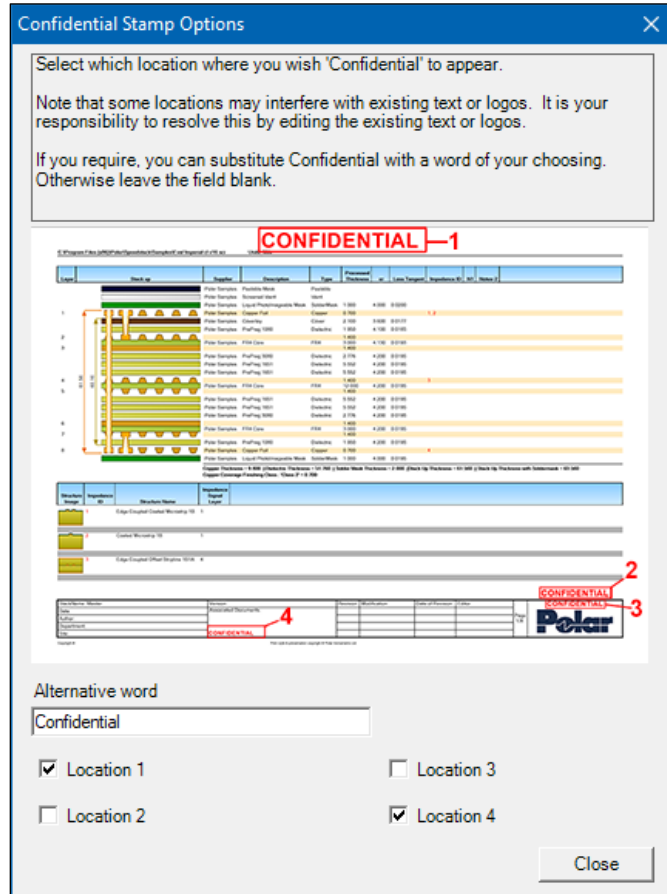

The notice wording may be changed from Confidential to other text as appropriate.

The specified text may be displayed in up to four predefined locations as shown in the dialog.

Click the check box for each required location.

Speedstack Stackup XML Information (.STKX) v25.00

General Notes

The Speedstack XML format is divided into a number of sections, and each section is described below. It is necessary to provide the Header section and the Stack Collection section within the file, but the Drill Collection and Impedance Structure Collection are optional.

Unused String fields should be set to a null string. Unused Numeric fields should be set to 0.

Header Section

<Version>	<p>This field defines the actual version of the Speedstack Stack Up XML file. The Stack Up XML file format may change in the future as we introduce new features, so this field can be used to verify whether an import / export processors will support a particular XML format.</p> <p>Numeric. 25.00</p>
<Units>	<p>Units used throughout the XML file.</p> <p>Numeric field.</p> <p>The mapping is as follows:</p> <p>3=microns 4=mils 5=mm 6=inch</p>
<StackDescription> <DateCreated> <Author> <Company> <Department> <Site> <FileVersion> <Revision1Number> <Revision1Modification> <Revision1Date> <Revision1Editor> <Revision2Number> <Revision2Modification> <Revision2Date> <Revision2Editor> <Revision3Number>	<p>Within Speedstack these fields are set using the File – Properties option</p> <p>String fields. Optional</p>

<Revision3Modification> <Revision3Date> <Revision3Editor> <Revision4Number> <Revision4Modification> <Revision4Date> <Revision4Editor> <AssociatedDocuments> <TopSideLabel> <BottomSideLabel>	
<Notes>	Stack up notes that are set using the Stack Up Editor tab String field.
<BoardThickness> <BoardThickPosTol> <BoardThickNegTol>	Target board thickness (stack up thickness from the first to the last electrical layer) and tolerance that are set using the Tools – Set Board Dimensions dialog Numeric. In specified Units Numeric. Positive tolerance percentage Numeric. Negative tolerance percentage
<HatchProfile> <HatchPitch> <HatchWidth> <HatchSet>	Hatched Plane profile section. A single set of hatch properties can be set for a stack up; all hatched planes within the stack have the same set of hatch properties. See Hatch Configuration dialog within Speedstack for more information Numeric. Hatch pitch Numeric: Hatch width Boolean: True if hatch planes are used in stack up

Stack Collection Section <StackCollection>

This section defines each material object included within the stack up, starting from the top of the stack. The following material objects are supported: <Foil>, <Prepreg>, <Core>, <RCC>, <SolderMask>, <Ident>, <Peelable>, <FlexCore>, <Adhesive>, <Bondply>, <Coverlay>, <Shield>

<Foil>

<FoilMaterial>	Each foil will have a FoilMaterial section. Within Speedstack these fields are set using the material library and / or stack up material properties option String. Type
----------------	--

<p><Type></p> <p><Supplier></p> <p><SupplierDescription></p> <p><Description></p> <p><StockNumber></p> <p><Cost></p> <p><LeadTime></p> <p><Notes1></p> <p><Notes2></p> <p><Notes3></p> <p><Notes4></p> <p><Notes5></p> <p><Attributes></p>	<p>String. Supplier</p> <p>String. Supplier Description</p> <p>String. Description</p> <p>String. Stock Number</p> <p>Numeric. Cost</p> <p>Numeric. Lead</p> <p>String. Single element materials</p> <p>Used to store material attributes. Speedstack will assign attributes in the following format. The (pipe) delimiter allows for multiple attributes to be assigned to a single material</p> <p><FieldID>=<Value> eg. NVDP=-1</p> <p>String</p>
<p><Copper></p> <p><TrackMirrored></p>	<p>Each foil will have a Copper section. Within Speedstack these fields are set using the material library and / or stack up material properties option. The values of these fields will have a direct impact on the overall stack up thickness and impedance structure parameters.</p> <p>Boolean. Used to determine whether the trapezoidal shape of the trace is mirrored.</p> <p>False: Not mirrored, trapezoidal shape pointing towards the top of stack up</p> <p>True: Mirrored, trapezoidal shape pointing towards the bottom of stack up</p>

<CuRMS>	Numeric. Copper Surface Roughness value. Optional
<CuBaseThickness>	Numeric. Copper Base Thickness
<CuFinishedThickness>	Numeric. Copper Finished Thickness (after plating)
<CopperCoverage>	Numeric. Percentage of copper coverage
<LayerType>	<p>Numeric. Layer Type</p> <p>Layer type mapping is as follows:</p> <p>0=Plane</p> <p>1=Signal</p> <p>2=Mixed</p> <p>3=No Copper – used with <Core> or <FlexCore>for single-sided copper cores and non-copper cores. See <Core> <CopperPresent> section for more info</p> <p>5=Hatched</p>
<ElectricalLayer>	Numeric. Incrementing number representing the electrical layer number. Electrical layers start from 1 at the top of the stack. Duplicate electrical layer numbers are not supported.
<LayerName>	String. Speedstack will use the automatic layer numbers <ElectricalLayer> but this field allows companies to also specify their own descriptions to match existing layer naming conventions
<DataFile>	String. Data filename for layer. This field is most commonly used to identify the CAM data file name (gerber file name) that contains the X Y data for the electrical layer
<Colour>	RGB colour

<Prepreg>

<PrepregMaterial>	<p>Each prepreg will have a PrepregMaterial section. Within Speedstack these fields are set using the material library and / or stack up material properties option</p> <p>See <Foil> - <FoilMaterial> for a description of the fields.</p>
-------------------	---

<Dielectric>	<p>Each prepreg will have a Dielectric section. Within Speedstack these fields are set using the material library and / or stack up material properties option. The values of these fields will have a direct impact on the overall stack up thickness and impedance structure parameters.</p> <p>For a description of Base, Finished and Isolation thickness please see application note AP507.</p>
<DielectricBaseThickness>	Numeric. Base Thickness of dielectric material
<DielectricFinishedThickness>	Numeric. Finished Thickness of dielectric material
<DielectricConstant>	Numeric. Dielectric constant of material
<LossTangent>	Numeric. Loss tangent of material
<ResinContent>	Numeric. Optional
<IsolationDistance>	Numeric. Isolation Distance of dielectric material
<Tg>	Numeric. Optional
<Td>	Numeric. Optional
<CAFResistance>	Numeric. Optional
<ZAxisExpansion>	Numeric. Optional
<ExcessResin>	Numeric. Optional. This field is only required if the Speedstack Resin Starvation DRC check is to be used
<Hvalue>	Numeric. Internal Speedstack field, set to 0.
<Colour>	RGB colour

<Core>

<p><CoreMaterial></p> <p><UpperCopperNotes1> <UpperCopperNotes2> <UpperCopperNotes3> <UpperCopperNotes4> <UpperCopperNotes5></p> <p><DielectricNotes1> <DielectricNotes2> <DielectricNotes3> <DielectricNotes4> <DielectricNotes5></p> <p><LowerCopperNotes1> <LowerCopperNotes2> <LowerCopperNotes3> <LowerCopperNotes4> <LowerCopperNotes5></p>	<p>Each core will have a CoreMaterial section. Within Speedstack these fields are set using the material library and / or stack up material properties option</p> <p>See <Foil> - <FoilMaterial> for a description of the fields.</p> <p>String. Three element materials</p>
--	--

<p><CopperPresent></p> <p><TopCopperPresent></p> <p><BottomCopperPresent></p>	<p>The CopperPresent section is used to determine whether the core material being used has copper on both, one or no sides. These options are commonly used for single sided copper cores and non-copper cores.</p> <p>Boolean. True if copper on the top of the core is present.</p> <p>Boolean. True if copper on the bottom of the core is present.</p>
---	--

<p><UpperCopper></p>	<p>The UpperCopper section describes the copper on the upper side of the Core.</p> <p>See <Foil> - <Copper> for a description of the fields.</p>
----------------------------	---

<CoreDielectric>	The CoreDielectric section describes the dielectric region of the Core. See <Prepreg> - <Dielectric> for a description of the fields.
------------------	--

<LowerCopper>	The LowerCopper section describes the copper on the lower side of the Core. See <Foil> - <Copper> for a description of the fields.
---------------	---

<RCC>

<RCCMaterial> <CopperNotes1> <CopperNotes2> <CopperNotes3> <CopperNotes4> <CopperNotes5> <DielectricNotes1> <DielectricNotes2> <DielectricNotes3> <DielectricNotes4> <DielectricNotes5>	Each Resin Coated Copper (RCC) will have a RCCMaterial section. Within Speedstack these fields are set using the material library and / or stack up material properties option See <Foil> - <FoilMaterial> for a description of the fields. String. Two element materials
<RCCCopper>	The RCCCopper section describes the copper on the RCC material See <Foil> - <Copper> for a description of the fields.
<RCCDielectric>	The RCCDielectric section describes the dielectric region of the RCC material See <Prepreg> - <Dielectric> for a description of the fields.

<SolderMask>

<SolderMaskMaterial>	Each SolderMask will have a SolderMask Material section. Within Speedstack these fields are set using the material library and / or stack up material properties option See <Foil> - <FoilMaterial> for a description of the fields.
----------------------	---

<SolderMaskMask>	Each SolderMask will have a SolderMaskMask section. Within Speedstack these fields are set using the material library and / or stack up material properties option. The values of these fields will have direct impact on the impedance structure parameters.
<MaskThickness>	Numeric. Thickness of mask material
<DielectricConstant>	Numeric. Dielectric constant of material
<LossTangent>	Numeric. Loss tangent of material
<MaskColour>	String. Optional
<DataFile>	String. Data filename for layer. This field is most commonly used to identify the CAM data file name (gerber file name) that contains the X Y data for the solder mask layer
<Colour>	RGB colour

<Ident>

<IdentMaterial>	Each Ident will have an IdentMaterial section. Within Speedstack these fields are set using the material library and / or stack up material properties option See <Foil> - <FoilMaterial> for a description of the fields.
-----------------	---

<IdentInk>	Each Ident will have an IdentInk section. Within Speedstack these fields are set using the material library and / or stack up material properties option.
<InkThickness>	Numeric. Thickness of ink
<InkColour>	String. Optional
<DataFile>	String. Data filename for layer. This field is most commonly used to identify the CAM data file name (gerber file name) that contains the X Y data for the ident layer
<Colour>	RGB colour

<Peelable>

<PeelableMaterial>	Each Peelable will have a PeelableMaterial section. Within Speedstack these fields are set using the material library and / or stack up material properties option See <Foil> - <FoilMaterial> for a description of the fields.
--------------------	--

<PeelableMask>	Each Peelable will have a PeelableMask section. Within Speedstack these fields are set using the material library and / or stack up material properties option.
<InkThickness>	Numeric. Thickness of ink
<InkColour>	String. Optional
<DataFile>	String. Data filename for layer. This field is most commonly used to identify the CAM data file name (gerber file name) that contains the X Y data for the peelable layer
<Colour>	RGB colour

<FlexCore>

<FlexCoreMaterial>	Each flexcore will have a FlexCoreMaterial section. Within Speedstack these fields are set using the material library and / or stack up material properties option
<UpperCopperNotes1>	
<UpperCopperNotes2>	
<UpperCopperNotes3>	See <Foil> - <FoilMaterial> for a description of the fields.
<UpperCopperNotes4>	
<UpperCopperNotes5>	String. Three element materials
<DielectricNotes1>	
<DielectricNotes2>	
<DielectricNotes3>	
<DielectricNotes4>	
<DielectricNotes5>	
<LowerCopperNotes1>	
<LowerCopperNotes2>	
<LowerCopperNotes3>	
<LowerCopperNotes4>	
<LowerCopperNotes5>	

<CopperPresent>	The CopperPresent section is used to determine whether the core material being used has copper on both, one or no sides. These options are commonly used for single sided copper cores and non-copper cores.
<TopCopperPresent>	Boolean. True if copper on the top of the core is present.
<BottomCopperPresent>	Boolean. True if copper on the bottom of the core is present.

<UpperCopper>	The UpperCopper section describes the copper on the upper side of the Core. See <Foil> - <Copper> for a description of the fields.
---------------	---

<CoreDielectric>	The CoreDielectric section describes the dielectric region of the Core. See <Prepreg> - <Dielectric> for a description of the fields.
------------------	--

<LowerCopper>	The LowerCopper section describes the copper on the lower side of the Core. See <Foil> - <Copper> for a description of the fields.
---------------	---

<Adhesive>

<AdhesiveMaterial>	Each Adhesive will have a AdhesiveMaterial section. Within Speedstack these fields are set using the material library and / or stack up material properties option See <Foil> - <FoilMaterial> for a description of the fields.
--------------------	--

<Dielectric>	The Dielectric section describes the dielectric region of the Adhesive. See <Prepreg> - <Dielectric> for a description of the fields.
--------------	--

<Bondply>

<BondplyMaterial>	Each Bondply will have a BondplyMaterial section. Within Speedstack these fields are set using the material library and / or stack up material properties option See <Foil> - <FoilMaterial> for a description of the fields.
-------------------	--

<Dielectric>	The Dielectric section describes the dielectric region of the Bondply. See <Prepreg> - <Dielectric> for a description of the fields.
--------------	---

<Coverlay>

<CoverlayMaterial>	Each Coverlay will have a Coverlay Material section. Within Speedstack these fields are set using the material library and / or stack up material properties option See <Foil> - <FoilMaterial> for a description of the fields.
--------------------	---

<CoverlayFilm>	Each Coverlay will have a CoverlayFilm section. Within Speedstack these fields are set using the material library and / or stack up material properties option. The values of these fields will have direct impact on the impedance structure parameters.
<DielectricBaseThickness>	Numeric. Base Thickness of dielectric material
<DielectricFinishedThickness>	Numeric. Finished Thickness of dielectric material
<DielectricConstant>	Numeric. Dielectric constant of material
<LossTangent>	Numeric. Loss tangent of material
<Colour>	RGB colour

<Shield>

<p><ShieldMaterial></p> <p><CopperNotes1></p> <p><CopperNotes2></p> <p><CopperNotes3></p> <p><CopperNotes4></p> <p><CopperNotes5></p> <p><DielectricNotes1></p> <p><DielectricNotes2></p> <p><DielectricNotes3></p> <p><DielectricNotes4></p> <p><DielectricNotes5></p>	<p>Each Shield will have a ShieldMaterial section. Within Speedstack these fields are set using the material library and / or stack up material properties option</p> <p>See <Foil> - <FoilMaterial> for a description of the fields.</p> <p>String. Two element materials</p>
---	--

<p><ShieldCopper></p>	<p>The ShieldCopper section describes the copper / metal of the Shield material</p> <p>See <Foil> - <Copper> for a description of the fields.</p>
-----------------------------	---

<p><ShieldDielectric></p>	<p>The ShieldDielectric section describes the dielectric region of the Shield material</p> <p>See <Prepreg> - <Dielectric> for a description of the fields.</p>
---------------------------------	---

Drill Collection Section <DrillCollection>

This section defines each drill object included within the stack up and there is a separate drill object for each drill operation within the stack up. The presence of a drill object affects the Copper Finishing functionality of Speedstack, and determines which electrical layers have additional copper added to the base copper thickness to allow for the electroplating fabrication process.

<p><Drill></p> <p><FirstElectricalLayer></p> <p><SecondElectricalLayer></p>	<p>A drill object defines each separate drill operation.</p> <p>Numeric. First electrical layer for the drill. It is important to correctly define the first / second electrical layers as this determines the direction / shape of laser drills. For laser drills the first electrical layer represents the entry layer and therefore has the widest dimension.</p> <p>Numeric. Second electrical layer for the drill. Not used with Back Drills</p>
---	---

<MechanicalDrill>	Boolean. True represents mechanical drill. Used in conjunction with LaserDrill and BackDrill i.e. Only one of MechanicalDrill or LaserDrill or BackDrill should be true
<LaserDrill>	Boolean. True represents laser drill.
<BackDrill>	Boolean. True represents back drill.
<ThroughPlated>	Boolean. True denotes that drill is through plated. Please note, when <BackDrill> is True <ThroughPlated> must be False
<FirstElectricalLayerCapped>	Boolean. True denotes first electrical layer is capped
<SecondElectricalLayerCapped>	<p>Boolean. True denotes second electrical layer is capped</p> <p>Mechanical supports first and / or second layer capped.</p> <p>Laser supports first layer capped only.</p> <p>Back Drill supports first layer capped only.</p>
<DrillSpec>	<p>Numeric bitmask (binary). This is the drill description as an integer</p> <p>512 = Back Drill 256 = Laser 128 = Plated 64 = Copper paste 32 = Sintering paste 16 = Conductive 8 = Non-conductive 4 = Solder mask fill 2 = Resin fill 1 = Copper fill 0 = Mechanical</p> <p>E.g. for a Copper filled plated laser via = 385</p>
<DataFile>	String. Data filename for drill. This field is most commonly used to identify the CAM data file name (drill file name) that contains the X Y data for the drill operation.
<HoleCount>	Numeric. Optional.
<DifferentHoleSizes>	Numeric. Optional.
<MinimumHoleSize>	Numeric. Optional. Smallest drill diameter for drill operation. Necessary if Speedstack DRC – Aspect Ratio checks are required
<TraceColumn>	<p>Numeric. 0 based index as to where the drill operation will be positioned on the stack up graphic.</p> <p>0 – left most column 10 – right most column</p>

	Consideration must be given so that Mechanical and Laser drill operations do not overlap within the same trace column. Back Drills may overlap Mechanical drills
<MinimumPadSize>	Numeric. Optional.
<MinimumDrillSize>	Numeric. Optional.
<MinimumDrillSizeTolerance>	Numeric. Optional. Absolute tolerance
<MinimumBarrelWallThickness>	Numeric. Optional.
<BackDrillMustCutLayer>	Numeric. The electrical layer of the stack up that has to be cut (drilled through). This property must be used in conjunction with FirstElectricalLayer and BackDrillMustNotCutLayer to define the direction and stopping layer of the Back Drill. Only used with Back Drills
<BackDrillMustNotCutLayer>	Numeric. The electrical layer of the stack up that must not be cut. Only used with Back Drills
<BackDrillMinimumDistanceFromCutLayer>	Numeric. Optional.
<BackDrillMaximumDistanceFromCutLayer>	Numeric. Optional.
<BackDrillPrimaryDrillSize>	Numeric. Optional.
<BackDrillMinimumDistanceFromNotCutLayer>	Numeric. Optional.
<BackDrillMaximumDistanceFromNotCutLayer>	Numeric. Optional.
<BackDrillType>	Numeric. Back Drill Type Back Drill Type mapping is as follows: Numeric. Back Drill Type Back Drill Type mapping is as follows: 0=Pointed 1=Flat 2=Router
<Note1>	String
<Note2>	String
<Note3>	String
<Note4>	String
<Note5>	String

Impedance Structure Collection Section <StructureCollection>

This section defines each impedance structure included within the stack up. Structures must be placed appropriately within the stack up. Please use the guidance notes below.

<Structure>	A structure object defines each separate impedance structure.
<StructureName>	String. A valid impedance structure name must be provided. See guidance notes below
<StructureNumber>	Number. A valid impedance structure name must be provided. See guidance notes below
<UpperSignalLayer>	Numeric. Electrical layer number to which impedance signal is assigned, the <Copper> <ElectricalLayer>. The <Copper> <LayerType> must be set to Signal or Mixed.
<LowerSignalLayer>	Numeric. For Differential Broadside structures this is the second electrical layer number. The <Copper> < LayerType> must be set to Signal or Mixed
<UpperPlane>	Numeric. First reference plane electrical layer number, the <Copper> <ElectricalLayer>. The <Copper> < LayerType> must be set to Plane, Mixed or Hatched.
<LowerPlane>	<p>Numeric. Second reference plane electrical layer number, the <Copper> <ElectricalLayer>. The <Copper> <LayerType> must be set to Plane, Mixed or Hatched.</p> <p>When an impedance structure only has a single reference plane (microstrip structures) it is only necessary to specify the UpperPlane.</p> <p>Impedance structures with two reference planes (stripline structures) must have both the UpperPlane and LowerPlane specified</p>
<H1>	Numeric. Substrate 1 height
<Er1>	Numeric. Substrate 1 dielectric constant
<H2>	Numeric. Substrate 2 height
<Er2>	Numeric. Substrate 2 dielectric constant
<H3>	Numeric. Substrate 3 height

<Er3>	Numeric. Substrate 3 dielectric constant
<H4>	Numeric. Substrate 4 height
<Er4>	Numeric. Substrate 4 dielectric constant
<W1>	Numeric. Lower trace width
<W2>	Numeric. Upper trace width
	W1 and W2 allows for a trapezoidal trace shape to be defined. If the trace shape is rectangular set W1 and W2 to the same dimension
<S1>	Numeric. Trace separation, for differential structures only
<O1>	Numeric. Trace offset, for broadside structures only
<G1>	Numeric. Lower ground strip width, for coplanar ground strip structures only
<G2>	Numeric. Upper ground strip width, for coplanar ground strip structures only
	G1 and G2 allows for a trapezoidal ground strip shape to be defined. If the ground strip is rectangular set G1 and G2 to the same dimension
<D1>	Numeric. Ground strip separation, for coplanar structures only
<T1>	Numeric. Trace thickness
<REr>	Numeric value for the Dielectric (REr) for resin rich area structures only.
<C1>	Numeric. Coating above substrate
<C2>	Numeric. Coating above trace
<C3>	Numeric. Coating between traces for differential structures only

<CEr>	Numeric. Coating dielectric constant
<Impedance>	Numeric. Calculated impedance result in ohms. Generated by Speedstack, so export processor should leave this value at 0
<TargetImpedance>	Numeric. Structure target impedance value in ohms
<Tolerance>	Numeric. Impedance + / - tolerance as a percentage
<Note1>	String
<Note2>	String
<Note3>	String
<Note4>	String
<Note5>	String
<NetClass1>	String
<NetClass2>	String
<NetClass3>	String
<NetClass4>	String
<NetClass5>	String
Frequency Dependent Properties	
<FD_LengthOfLine>	Numeric. Length of transmission line in current units
<FD_TraceConductivity>	Numeric. Trace Conductivity in Siemens per metre (S/m)

Speedstack calculates insertion loss over a frequency range. All frequency parameters are in Hz	
<FD_FrequencyMin>	Numeric. Hz
<FD_FrequencyMax>	Numeric. Hz
<FD_FrequencySteps>	Numeric integer. Number of frequency data points to be calculated between Min and Max
<FD_FrequencyOfInterest>	Numeric. Hz
<FD_ResultPresentation>	Numeric. Result presentation of frequency dependent calculation. The mapping is as follows: 0=per length of line (/LL) 1=per inch (/in) 2=per metre (/m)
Extended Substrate Data causal extrapolation reference points. See page 96 of the Speedstack manual for further info. All XML elements are included regardless of structure type, only substrates used by the structure will impact on the calculation result	
<FD_ESD_SetRefPointsFromStackup_Er>	Boolean. Controls the 'Set Dielectric Constant (Er) values from Stack Up materials' checkbox. Setting this value to True auto-populates the Ref Er column, False allows the user to key in the value(s)
<FD_ESD_SetRefPointsFromStackup_TanD >	Boolean. Controls the 'Set Loss Tangent (TanD) values from Stack Up materials' checkbox. Setting this value to True auto-populates the Ref TanD column, False allows the user to key in the value(s)
<FD_ESD_H1RefFreq>	Numeric. Hz
<FD_ESD_H1RefEr>	Numeric. Dielectric constant
<FD_ESD_H1RefTanD>	Numeric. Loss tangent
<FD_ESD_H2RefFreq>	Numeric. Hz
<FD_ESD_H2RefEr>	Numeric. Dielectric constant

<FD_ESD_H2RefTanD>	Numeric. Loss tangent
<FD_ESD_H3RefFreq>	Numeric. Hz
<FD_ESD_H3RefEr>	Numeric. Dielectric constant
<FD_ESD_H3RefTanD>	Numeric. Loss tangent
<FD_ESD_H4RefFreq>	Numeric. Hz
<FD_ESD_H4RefEr>	Numeric. Dielectric constant
<FD_ESD_H4RefTanD>	Numeric. Loss tangent
<FD_ESD_RErRefFreq>	Numeric. Hz
<FD_ESD_RErRefEr>	Numeric. Dielectric constant
<FD_ESD_RErRefTanD>	Numeric. Loss tangent
<FD_ESD_CErRefFreq>	Numeric. Hz
<FD_ESD_CErRefEr>	Numeric. Dielectric constant
<FD_ESD_CErRefTanD>	Numeric. Loss tangent
<p>Surface Roughness Compensation. See pages 96 – 98 of the Speedstack manual for further info. All XML elements are included regardless of structure type, only roughness surfaces used by the structure will impact on the calculation result</p>	
<FD_SRC_Model>	<p>Numeric. The mapping is as follows:</p> <p>0=Smooth</p> <p>1=Hammerstad</p> <p>2=Groisse</p> <p>3=Huray</p> <p>5=Gradient</p>
<FD_SRC_RMS_R1>	Numeric. Surface 1 roughness RMS value in current units for Hammerstad / Groisse / Gradient model

<FD_SRC_RMS_R2>	Numeric. Surface 2 roughness RMS value in current units for Hammerstad / Grosse / Gradient model
<FD_SRC_RMS_R3>	Numeric. Surface 3 roughness RMS value in current units for Hammerstad / Grosse / Gradient model
<FD_SRC_RMS_R4>	Numeric. Surface 4 roughness RMS value in current units for Hammerstad / Grosse / Gradient model
<FD_SRC_RMS_R5>	Numeric. Surface 5 roughness RMS value in current units for Hammerstad / Grosse / Gradient model
<FD_SRC_RMS_R6>	Numeric. Surface 6 roughness RMS value in current units for Hammerstad / Grosse / Gradient model
<FD_SRC_Huray_RatioOfAreas>	Numeric.
<FD_SRC_Huray_EffectiveBallRadius>	Numeric. Must be in microns (μm)
<FD_SRC_Huray_NumberOfBallsInArea>	Numeric.
<FD_SRC_Huray_AreaOfBallCount>	Numeric. Area must be square microns ($\text{sq } \mu\text{m}$)
<FD_SRC_Huray_EnableCannonballHuray>	Boolean. Determines whether Cannonball-Huray mode is enabled
<FD_SRC_Huray_RzMatte>	Numeric. Must be in microns (μm)
<FD_SRC_Huray_RzDrum>	Numeric. Must be in microns (μm)
<FD_IncludeOnReport>	Boolean. Controls the 'Include Loss Graph for this structure on the report' checkbox. Setting this value to True allows the user to nominate which structures will contain a separate loss graph page
<FD_LossBudget>	Numeric. As shown on the All Losses plot (dB)

Impedance Structure Guidance

Impedance structures must be placed appropriately on the defined stack up.

When specifying <UpperSignalLayer> and <LowerSignalLayer> they must be placed on electrical layers who's <LayerType> is defined as "signal" or "mixed".

When specifying <UpperPlane> and <LowerPlane> they must be placed on electrical layers who's <LayerType> is defined as "plane" or "mixed".

Often impedance structures do not require all parameters. Unused parameters fields should be set to 0.

The impedance calculation engine supplied with Speedstack contains 108 transmission line structures. Explaining every structure is beyond the scope of this document, but details of the most commonly used impedance structures are given below. Please contact polarcare@polarinstruments.com if you require information on other structures

Surface Microstrip Structures	
<p>Name: Surface Microstrip 1B</p> <p>Type: Single Ended</p> <p>Usage: Used on outer layers of a stackup when no solder mask is present</p>	
<p>Name: Edge Coupled Surface Microstrip 1B</p> <p>Type: Differential</p> <p>Usage: Used on outer layers of a stackup when no solder mask is present</p>	

Coated Microstrip Structures	
<p>Name: Coated Microstrip 1B</p> <p>Type: Single Ended</p> <p>Usage: Used on outer layers of a stackup when solder mask is present</p>	
<p>Name: Edge Coupled Coated Microstrip 1B</p> <p>Type: Differential</p> <p>Usage: Used on outer layers of a stackup when solder mask is present</p>	
Embedded Microstrip Structures	
<p>Name: Embedded Microstrip 1B1A</p> <p>Type: Single Ended</p> <p>Usage: Used on inner layers of a stackup when no reference plane exists between the impedance signal layer and the surface</p>	

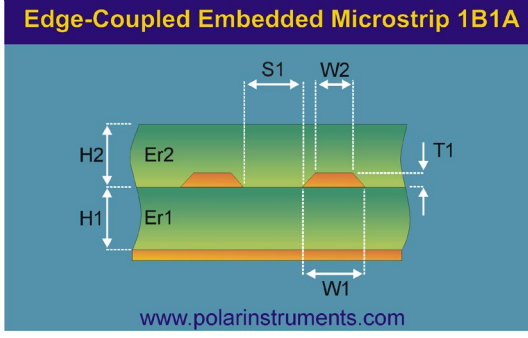
<p>Name: Edge Coupled Embedded Microstrip 1B1A</p> <p>Type: Differential</p> <p>Usage: Used on inner layers of a stackup when no reference plane exists between the impedance signal layer and the surface</p>	 <p>The diagram shows a cross-section of a PCB stackup with two dielectric layers, Er1 (bottom) and Er2 (top). Two signal layers are embedded within these dielectric layers. The bottom signal layer has a width W1 and is separated from the Er1 layer by a thickness T1. The top signal layer has a width W2 and is separated from the Er2 layer by a thickness T1. The distance between the centerlines of the two signal layers is S1. The overall thickness of the Er2 layer is H2, and the overall thickness of the Er1 layer is H1. The diagram is titled 'Edge-Coupled Embedded Microstrip 1B1A' and includes the website 'www.polarinstruments.com'.</p>
--	--

Offset Stripline Structures

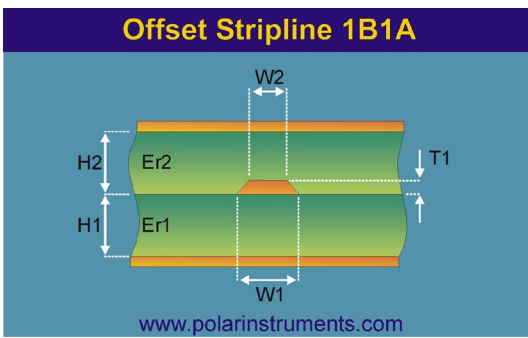
<p>Name: Offset Stripline 1B1A</p> <p>Type: Single Ended</p> <p>Usage: Used on inner layers of a stackup when a reference plane exists above and below the impedance signal layer</p>	 <p>The diagram shows a cross-section of a PCB stackup with two dielectric layers, Er1 (bottom) and Er2 (top). A single signal layer is embedded within the Er2 layer. The signal layer has a width W2 and is separated from the Er2 layer by a thickness T1. The bottom signal layer has a width W1 and is separated from the Er1 layer by a thickness T1. The overall thickness of the Er2 layer is H2, and the overall thickness of the Er1 layer is H1. The diagram is titled 'Offset Stripline 1B1A' and includes the website 'www.polarinstruments.com'.</p>
---	---

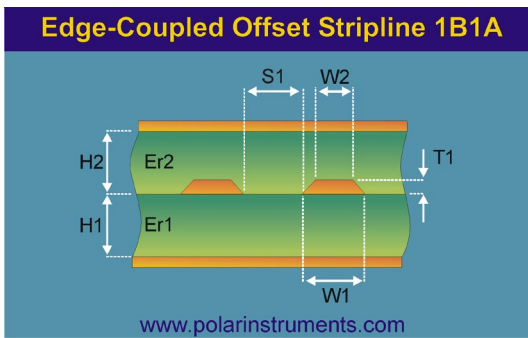
<p>Name: Edge Coupled Offset Stripline 1B1A</p> <p>Type: Differential</p> <p>Usage: Used on inner layers of a stackup when a reference plane exists above and below the impedance signal layer</p>	 <p>The diagram shows a cross-section of a PCB stackup with two dielectric layers, Er1 (bottom) and Er2 (top). Two signal layers are embedded within these dielectric layers. The bottom signal layer has a width W1 and is separated from the Er1 layer by a thickness T1. The top signal layer has a width W2 and is separated from the Er2 layer by a thickness T1. The distance between the centerlines of the two signal layers is S1. The overall thickness of the Er2 layer is H2, and the overall thickness of the Er1 layer is H1. The diagram is titled 'Edge-Coupled Offset Stripline 1B1A' and includes the website 'www.polarinstruments.com'.</p>
--	---

Speedstack Stackup XML Information (.SSX) v15.00

Document Date: 28th August 2024 – Draft 1

General Notes

The Speedstack XML format is divided into two main sections: the header section and the sub-stack section(s).

The header describes details about the stack up construction, the units used for each of the sub-stacks defined and number of sub-stacks etc.

The sub-stack sections describes a Stack Collection detailing the materials used, Drill Collection describing the drills that exist on that sub-stack and a Structure Collection that includes the controlled impedance structures that exist on that sub-stack.

The number of sub-stack sections included in the XML file will match the number of sub-stacks in the construction; for a traditional rigid stack up a single sub-stack will be defined but for a complex rigid-flex construction each cross-section will be described as a separate sub-stack.

Unused String fields should be set to a null string. Unused Numeric fields should be set to 0.

Header Section

<Version>	<p>This field defines the actual version of the Speedstack Stack Up XML file. The Stack Up XML file format may change in the future as we introduce new features, so this field can be used to verify whether an import / export processors will support a particular XML format.</p> <p>Numeric field. 15.00 is the version number described in this document.</p>
<Units>	<p>Units used throughout the XML file.</p> <p>Numeric field</p> <p>The mapping is as follows:</p> <p>3=microns 4=mils 5=mm 6=inch</p>
<NumberOfSubStacks>	<p>The number of sub-stacks contained within the XML file, this value should match the number of <SubStack> sections.</p> <p>A single rigid stack up would have a value of 1 whereas a rigid-flex construction contains five separate sub-stack cross sections would have a value of 5.</p> <p>Numeric field</p>

<p><SubStackDisplayOrder></p>	<p>Each <SubStack> has a unique zero-based <Index> to identify the order in which it was created. Speedstack allows the user to display the sub-stacks in any order and the <SubStackDisplayOrder> collection describes this display order. The <Index> entries within this collection describe the rigid-flex construction from left to right. The number of <Index> elements must match the number of sub-stacks described by <NumberOfSubStacks></p>
<p><FileProperties></p> <p><DescriptiveStackName></p> <p><StackTopSideLabel></p> <p><StackBottomSideLabel></p> <p><DateCreated></p> <p><Version></p> <p><Revision1Number></p> <p><Revision1Modification></p> <p><Revision1Date></p> <p><Revision1Editor></p> <p><Revision2Number></p> <p><Revision2Modification></p> <p><Revision2Date></p> <p><Revision2Editor></p> <p><Revision3Number></p> <p><Revision3Modification></p> <p><Revision3Date></p> <p><Revision3Editor></p> <p><Revision4Number></p> <p><Revision4Modification></p> <p><Revision4Date></p> <p><Revision4Editor></p> <p><Author></p> <p><Company></p> <p><Department></p> <p><Site></p> <p><AssociatedDocuments></p>	<p>Within Speedstack these field are set using the File – Properties options</p> <p>String fields</p>

SubStack Section <SubStack>

<Index>	<p>Unique zero-based <Index> to identify the order in which the sub-stack was created.</p> <p>Numeric field</p>
<Name>	<p>Name allocated to the sub-stack from the Speedstack Navigator.</p> <p>The name does not have to be unique as the <Index> is used as the sub-stack identifier.</p> <p>String field</p>
<FullName>	<p>Within Speedstack the full name of the sub-stack is <DescriptiveStackName> & "/" & <Name></p> <p>String field</p>
<Notes>	<p>Stack up notes that are set using the Stack Up Editor tab</p> <p>String field</p>
<ElectricalLayerCount>	<p>Number of electrical layers enabled within the sub-stack</p> <p>Numeric field</p>
<CopperThickness>	<p>The thickness of all the enabled copper layers in the sub-stack (foil, cores, flex core, rcc)</p> <p>Numeric field</p>
<DielectricThickness>	<p>The thickness of all the enabled dielectric layers in the sub stack (prepreg, core, adhesive etc)</p> <p>Numeric field</p>
<SolderMaskThickness>	<p>The thickness of the enabled top and / or bottom soldermask</p> <p>Numeric field</p>
<TargetStackUpThickness>	<p>Each sub-stack can have a separate target thickness as entered by the user</p> <p>Numeric field</p>
<TargetStackUpThicknessPosTolPercentage>	<p>Positive tolerance percentage entered by user</p> <p>Numeric field</p>

<TargetStackUpThicknessNegTolPercentage>	<p>Negative tolerance percentage entered by user.</p> <p>Numeric field</p> <p>Speedstack uses the <TargetStackUpThickness>, <TargetStackUpThicknessPosTolPercentage> and the <TargetStackUpThicknessNegTolPercentage> to warn the user whilst they are editing the stack when <StackUpThickness> exceeds the target</p>
<StackUpThickness>	<p>= <CopperThickness> + <DielectricThickness></p> <p>Numeric field</p>
<StackUpThicknessWithSolderMask>	<p>= <CopperThickness> + <DielectricThickness> + <SolderMaskThickness></p> <p>Numeric field</p>
<MiniStacksPresent>	<p>This element determines how impedance structures are managed within the sub-stack. Within Speedstack it is possible to enable non-consecutive electrical layers, for instance on an eight layer stack up just L2 / L3 and L6 / L7 cores are enabled. When an impedance structure is added to L3 it is necessary for the user to nominate how structures will be managed, will L2 / L3 be a separate mini stack up for impedance calculations than L6 / L7?</p> <p>Numeric field</p> <p>The mapping is as follows:</p> <p>0=no impedance structures exist on sub stack</p> <p>1=all enabled sub stack materials are treated as one contiguous stack up</p> <p>2=the enabled layers are treated as if an air gap exists between them</p> <p>3=consecutive enabled electrical layer material groups are treated as separate mini stack ups</p>
<HatchProfile>	<p>Hatched Plane profile section. A single set of hatch properties can be set for a sub-stack; all hatched planes within the sub-stack have the same set of hatch properties. See Hatch Configuration dialog within Speedstack for more information</p>

<HatchSet>	Boolean: True if hatch planes are used in the sub-stack
<HatchPitch>	Numeric: Hatch pitch
<HatchWidth>	Numeric: Hatch width

Sub-stack Stack Collection Section <SubStack> <StackCollection>

This section defines each material object included within the sub-stack, starting from the top of the stack. The following higher level material objects are supported: <Foil>, <Core>, <RCC>, <Prepreg>, <SolderMask>, <FlexCore>, <Adhesive>, <Bondply>, <Coverlay>, <Ident>, <Peelable>, <Shield>. Each <SubStack> <StackCollection> has an identical set of materials, the materials that are actually used in a <SubStack> will have the <EnableMaterial> element set to True, unused materials are set to False.

Lower level material objects

The higher level materials objects (<Foil>, <Core>, <RCC>, <Prepreg> etc) make use of these lower level materials objects. The following section describes each of these objects.

<EnableMaterial>

Used by all higher level material objects.

<EnableMaterial>	Set to True if material is used within the <SubStack> Boolean
------------------	--

<GeneralInformation>

Used by all higher level material objects.

<GeneralInformation>	A series of descriptive fields used to describe the material, accessible within Speedstack by the material properties options
<Supplier>	String
<SupplierDescription>	String
<Description>	String
<StockNumber>	String
<Type>	String
<Cost>	Numeric
<LeadTime>	Numeric

<Notes>, <UpperCopperNotes>, <DielectricNotes>, <LowerCopperNotes>

Used by all higher level material objects.

<Notes>, <UpperCopperNotes>, <DielectricNotes> or <LowerCopperNotes>	User-definable notes fields
<Note1>	String
<Note2>	
<Note3>	
<Note4>	
<Note5>	

<Attributes>

Used by all higher level material objects.

<p><Attributes></p>	<p>Used to store material attributes. Speedstack will assign attributes in the following format. The (pipe) delimiter allows for multiple attributes to be assigned to a single material</p> <p><FieldID>=<Value> eg. NVDP=-1</p> <p>String</p>
---------------------------	--

<Copper>

<Foil>, <Core>, <RCC>, <FlexCore> and <Shield> all contain one or more copper definitions

<p><Copper></p> <p><BaseThickness></p> <p><FinishedThickness></p> <p><CopperCoverage></p> <p><LayerName></p> <p><DataFilename></p> <p><TraceInverted></p>	<p>Copper section. Within Speedstack these fields are set using the material library and / or stack up material properties option. The values of these fields will have a direct impact on the overall stack up thickness and impedance structure parameters.</p> <p>Numeric. Copper Base Thickness</p> <p>Numeric. Copper Finished Thickness (after plating)</p> <p>Numeric. Percentage of copper coverage</p> <p>String. Speedstack will use the automatic layer numbers <ElectricalLayer> but this field allows companies to also specify their own descriptions to match existing layer naming conventions</p> <p>String. Data filename for layer. This field is most commonly used to identify the CAM data file name (gerber file name) that contains the X Y data for the electrical layer</p> <p>Boolean. Used to determine whether the trapezoidal shape of the trace is mirrored.</p> <p>False: Not mirrored, trapezoidal shape pointing towards the top of stack up</p> <p>True: Mirrored, trapezoidal shape pointing towards the bottom of stack up</p>
---	---

<p><LayerType></p>	<p>Numeric. Layer Type</p> <p>Layer type mapping is as follows:</p> <p>0=Plane</p> <p>1=Signal</p> <p>2=Mixed</p> <p>3=No Copper – used with <Core> or <FlexCore>for single-sided copper cores and non-copper cores. See <Core> <CopperPresent> section for more info</p> <p>5=Hatched</p>
<p><ElectricalLayer></p>	<p>Numeric. Incrementing number representing the electrical layer number. Electrical layers start from 1 at the top of the stack. Duplicate electrical layer numbers are not supported.</p>
<p><Colour></p>	<p>RGB colour</p>

<Dielectric>

<Core>, <RCC>, <Prepreg>, <FlexCore>, <Adhesive>, <Bondply> and <Shield> all contain one dielectric definition.

<p><Dielectric></p>	<p>Dielectric section. Within Speedstack these fields are set using the material library and / or stack up material properties option. The values of these fields will have a direct impact on the overall stack up thickness and impedance structure parameters.</p> <p>For a description of Base, Finished and Isolation thickness please see application note AP507.</p>
<p><BaseThickness></p>	<p>Numeric. Base Thickness of dielectric material</p>
<p><FinishedThickness></p>	<p>Numeric. Finished Thickness of dielectric material</p>
<p><DielectricConstant></p>	<p>Numeric. Dielectric constant of material</p>
<p><LossTangent></p>	<p>Numeric. Loss tangent of material</p>
<p><ResinContentPercentage></p>	<p>Numeric. Resin content and as percentage</p>
<p><Tg></p>	<p>Numeric. Transition temperature</p>
<p><Td></p>	<p>Numeric. Decomposition temperature</p>

<CAFResistance>	Numeric.
<ZAxisExpansion>	Numeric.
<IsolationDistance>	Numeric. Isolation Distance of dielectric material
<ExcessResin>	Numeric. This field is only required if the Speedstack Resin Starvation DRC check is to be used. See application note AP509
<Colour>	RGB colour

<Mask>

<SolderMask> contains one definition.

<Mask>	Mask section. Within Speedstack these fields are set using the material library and / or stack up material properties option. The values of these fields will have a direct impact on the overall stack up thickness and impedance structure parameters.
<Thickness>	Numeric. Thickness of mask material
<DielectricConstant>	Numeric. Dielectric constant of material
<LossTangent>	Numeric. Loss tangent of material
<MaskColour>	String. Text description of mask colour
<DataFilename>	String. Data filename for layer. This field is most commonly used to identify the CAM data file name (gerber file name) that contains the X Y data for the electrical layer
<Colour>	RGB colour

<CoverlayFilm>

<Coverlay> contains one definition.

<CoverlayFilm>	CoverlayFilm section. Within Speedstack these fields are set using the material library and / or stack up material properties option. The values of these fields will have a direct impact on the overall stack up thickness and impedance structure parameters.
<BaseThickness>	Numeric. Base Thickness of film material
<FinishedThickness>	Numeric. Finished Thickness of film material

<DielectricConstant>	Numeric. Dielectric constant of material
<LossTangent>	Numeric. Loss tangent of material
<Colour>	RGB colour

<IdentInk>

<Ident> contains one definition.

<IdentInk>	Ink section. Within Speedstack these fields are set using the material library and / or stack up material properties option.
<Thickness>	Numeric. Thickness of ink
<InkColour>	String. Text description of ink colour
<DataFilename>	String. Data filename for layer. This field is most commonly used to identify the CAM data file name (gerber file name) that contains the X Y data for the electrical layer
<Colour>	RGB colour

<PeelableMask>

<Peelable> contains one definition.

<PeelableMask>	PeelableMask section. Within Speedstack these fields are set using the material library and / or stack up material properties option.
<Thickness>	Numeric. Thickness of peelable ink mask material
<InkColour>	String. Text description of peelable ink mask colour
<DataFilename>	String. Data filename for layer. This field is most commonly used to identify the CAM data file name (gerber file name) that contains the X Y data for the electrical layer
<Colour>	RGB colour

Higher level material objects

The higher level materials make extensive use of the lower level materials objects. The following section describes each higher level material and which objects it uses.

<Foil>

<EnableMaterial>	See definitions above
<GeneralInformation>	
<Copper>	
<Notes>	
<Attributes>	

<Core>

<EnableMaterial>	See definitions above
<GeneralInformation>	
<CopperPresent>	The CopperPresent section is used to determine whether the core material being used has copper on both, one or no sides. These options are commonly used for single sided copper cores and non-copper cores.
<UpperCopperPresent>	Boolean. True if copper on the upper surface of the core is present.
<BottomCopperPresent>	Boolean. True if copper on the lower surface of the core is present.
<UpperCopper>	Upper surface copper – see <Copper> definition above
<Dielectric>	
<LowerCopper>	Lower surface copper – see <Copper> definition above
<UpperCopperNotes>	

<DielectricNotes>	
<LowerCopperNotes>	
<Attributes>	

<RCC>

<EnableMaterial>	See definitions above
<GeneralInformation>	
<Copper>	In the case of <RCC> the <Copper>
<Dielectric>	<TraceInverted> Boolean element
<CopperNotes>	determines whether the copper is positioned
<DielectricNotes>	above or below the dielectric. Above = False,
<Attributes>	Below = True

<Prepreg>

<EnableMaterial>	See definitions above
<GeneralInformation>	
<Dielectric>	
<Notes>	
<Attributes>	

<SolderMask>

<EnableMaterial>	See definitions above
<GeneralInformation>	
<Mask>	
<Notes>	
<Attributes>	

<FlexCore>

This material is similar to <Core>

<EnableMaterial>	See definitions above
<GeneralInformation>	
<CopperPresent>	The CopperPresent section is used to determine whether the core material being used has copper on both, one or no sides. These options are commonly used for single sided copper cores and non-copper cores.
<UpperCopperPresent>	Boolean. True if copper on the upper surface of the core is present.
<BottomCopperPresent>	Boolean. True if copper on the lower surface of the core is present.
<UpperCopper>	Upper surface copper – see <Copper> definition above
<Dielectric>	
<LowerCopper>	Lower surface copper – see <Copper> definition above
<UpperCopperNotes>	
<DielectricNotes>	
<LowerCopperNotes>	
<Attributes>	

<Bondply>

<EnableMaterial>	See definitions above
<GeneralInformation>	
<Dielectric>	
<Notes>	
<Attributes>	

<Adhesive>

<EnableMaterial>	See definitions above
<GeneralInformation>	
<Dielectric>	
<Notes>	
<Attributes>	

<Coverlay>

<EnableMaterial>	See definitions above
<GeneralInformation>	
<CoverlayFilm>	
<Notes>	
<Attributes>	

<Ident>

<EnableMaterial>	See definitions above
<GeneralInformation>	
<IdentInk>	
<Notes>	
<Attributes>	

<Peelable>

<EnableMaterial>	See definitions above
<GeneralInformation>	
<PeelableMask>	
<Notes>	
<Attributes>	

<Shield>

<EnableMaterial>	See definitions above In the case of <Shield> the <Copper> <TraceInverted> Boolean element determines whether the copper is positioned above or below the dielectric. Above = False, Below = True
<GeneralInformation>	
<Copper>	
<Dielectric>	
<CopperNotes>	
<DielectricNotes>	
<Attributes>	

Sub-stack Drill Collection Section <SubStack> <DrillCollection>

This section defines each drill object included within the sub-stack, there is a separate drill object for each drill operation within the stack up. The presence of a drill object affects the Copper Finishing functionality of Speedstack, and determines which electrical layers have additional copper added to the base copper thickness to allow for the electroplating fabrication process. Each <SubStack> <DrillCollection> contains drill objects that only belong to the sub-stack.

<Drill>	A drill object defines each separate drill operation.
<Column>	Numeric. Zero-based index as to where the drill operation will be positioned on the stack up graphic. 0 – left most column 10 – right most column

	<p>Consideration must be given so that drill operations do not overlap within the same trace column.</p>
<p><FirstElectricalLayer></p>	<p>Numeric. First electrical layer for the drill. It is important to correctly define the first / second electrical layers as this determines the direction / shape of laser drills. For laser drills the first electrical layer represents the entry layer and therefore has the widest dimension. The first and second electrical layers must be on materials whose <EnableMaterial> is true</p>
<p><SecondElectricalLayer></p>	<p>Numeric. Second electrical layer for the drill Not used with Back Drills</p>
<p><Mechanical></p>	<p>Boolean. True represents mechanical drill. Used in conjunction with LaserDrill and BackDrill i.e. Only one of MechanicalDrill or LaserDrill or BackDrill should be true</p>
<p><Laser></p>	<p>Boolean. True represents laser drill.</p>
<p><BackDrill></p>	<p>Boolean. True represents back drill.</p>
<p><ThroughPlated></p>	<p>Boolean. True denotes that drill is through plated. Please note, when <BackDrill> is True <ThroughPlated> must be False</p>
<p><FirstElectricalLayerCapped></p>	<p>Boolean. True denotes first electrical layer is capped</p>
<p><SecondElectricalLayerCapped></p>	<p>Boolean. True denotes second electrical layer is capped</p> <p>Mechanical supports first and / or second layer capped.</p> <p>Laser supports first layer capped only.</p> <p>Back Drill supports first layer capped only.</p>
<p><DrillSpec></p>	<p>Numeric bitmask (binary). This is the drill description as an integer</p> <p>512 = Back Drill</p>

	<p>256 = Laser</p> <p>128 = Plated</p> <p>64 = Copper paste</p> <p>32 = Sintering paste</p> <p>16 = Conductive</p> <p>8 = Non-conductive</p> <p>4 = Solder mask fill</p> <p>2 = Resin fill</p> <p>1 = Copper fill</p> <p>0 = Mechanical</p> <p>E.g. for a Copper filled plated laser via = 385</p>
<DataFilename>	String. Data filename for drill. This field is most commonly used to identify the CAM data file name (drill file name) that contains the X Y data for the drill operation.
<HoleCount>	Numeric.
<DifferentHoleSizes>	Numeric.
<MinimumHoleSize>	Numeric. Smallest drill diameter for drill operation. Necessary if Speedstack DRC – Aspect Ratio checks are required
<MinimumPadSize>	Numeric. Optional.
<MinimumDrillSize>	Numeric. Optional.
<MinimumDrillSizeTolerance>	Numeric. Optional. Absolute tolerance
<MinimumBarrelWallThickness>	Numeric. Optional.
<BackDrillMustCutLayer>	Numeric. The electrical layer of the stack up that has to be cut (drilled through). This property must be used in conjunction with FirstElectricalLayer and BackDrillMustNotCutLayer to define the direction and stopping layer of the Back Drill.
<BackDrillMustNotCutLayer>	Only used with Back Drills Numeric. The electrical layer of the stack up that must not be cut. Only used with Back Drills

<BackDrillMinimumDistanceFromCutLayer>	Numeric. Optional.
<BackDrillMaximumDistanceFromCutLayer>	Numeric. Optional.
<BackDrillPrimaryDrillSize>	Numeric. Optional.
<BackDrillMinimumDistanceFromNotCutLayer>	Numeric. Optional.
<BackDrillMaximumDistanceFromNotCutLayer>	Numeric. Optional.
<BackDrillType>	Numeric. Back Drill Type Back Drill Type mapping is as follows: 0=Pointed 1=Flat 2=Router
<Notes>	User-definable notes fields
<Note1>	String
<Note2>	String
<Note3>	String
<Note4>	String
<Note5>	String

Impedance Structure Collection Section <SubStack> <StructureCollection>

This section defines each impedance structure included within the sub-stack.

Structures must be placed appropriately within the sub-stack, the <UpperSignalLayer>, <LowerSignalLayer>, <UpperPlaneLayer> and <LowerPlaneLayer> must be on materials whose <EnableMaterial> is true. Each <SubStack> <StructureCollection> contains structure objects that only belong to the sub-stack.

Different impedance structure types are identified by the <Name> and <Number> and will have a varying number of used parameters depending on the structure complexity. The <Structure> object contains all possible parameters, the parameters that are unused for a given structure should be set to 0.

Please use the guidance notes below.

<Structure>	A structure object defines each separate impedance structure.
<Name>	String. A valid impedance structure name must be provided. See guidance notes below
<Number>	Number. A valid impedance structure name must be provided. See guidance notes below
<UpperSignalLayer>	Numeric. Electrical layer number to which impedance signal is assigned, the <Copper> <ElectricalLayer>. The <Copper> <LayerType> must be set to Signal or Mixed.
<LowerSignalLayer>	Numeric. For Differential Broadside structures this is the second electrical layer number. The <Copper> < LayerType> must be set to Signal or Mixed
<UpperPlaneLayer>	Numeric. First reference plane electrical layer number, the <Copper> <ElectricalLayer>. The <Copper> < LayerType> must be set to Plane, Mixed or Hatched.
<LowerPlaneLayer>	<p>Numeric. Second reference plane electrical layer number, the <Copper> <ElectricalLayer>. The <Copper> <LayerType> must be set to Plane, Mixed or Hatched.</p> <p>When an impedance structure only has a single reference plane (microstrip structures) it is only necessary to specify the UpperPlane.</p> <p>Impedance structures with two reference planes (stripline structures) must have both the UpperPlane and LowerPlane specified</p>

<H1>	Numeric. Substrate 1 height
<Er1>	Numeric. Substrate 1 dielectric constant
<H2>	Numeric. Substrate 2 height
<Er2>	Numeric. Substrate 2 dielectric constant
<H3>	Numeric. Substrate 3 height
<Er3>	Numeric. Substrate 3 dielectric constant
<H4>	Numeric. Substrate 4 height
<Er4>	Numeric. Substrate 4 dielectric constant
<W1>	Numeric. Lower trace width
<W2>	Numeric. Upper trace width
	W1 and W2 allows for a trapezoidal trace shape to be defined. If the trace shape is rectangular set W1 and W2 to the same dimension
<S1>	Numeric. Trace separation, for differential structures only
<O1>	Numeric. Trace offset, for broadside structures only
<G1>	Numeric. Lower ground strip width, for coplanar ground strip structures only
<G2>	Numeric. Upper ground strip width, for coplanar ground strip structures only
	G1 and G2 allows for a trapezoidal ground strip shape to be defined. If the ground strip is rectangular set G1 and G2 to the same dimension
<D1>	Numeric. Ground strip separation, for coplanar structures only

<T1>	Numeric. Trace thickness
<REr>	Numeric value for the Dielectric (REr) for resin rich area structures only.
<C1>	Numeric. Coating above substrate
<C2>	Numeric. Coating above trace
<C3>	Numeric. Coating between traces for differential structures only
<CEr>	Numeric. Coating dielectric constant
<CalculatedImpedance>	Numeric. Calculated impedance result in ohms. Generated by Speedstack, so export processor should leave this value at 0
<TargetImpedance>	Numeric. Structure target impedance value in ohms
<Tolerance>	Numeric. Impedance + / - tolerance as a percentage
<Notes>	User-definable notes fields
<Note1>	String
<Note2>	String
<Note3>	String
<Note4>	String
<Note5>	String
<NetClasses>	NetClass fields
<NetClass1>	String
<NetClass2>	String
<NetClass3>	String

<NetClass4>	String
<NetClass5>	String
Frequency Dependent Properties	
<FD_LengthOfLine>	Numeric. Length of transmission line in current units
<FD_TraceConductivity>	Numeric. Trace Conductivity in Siemens per metre (S/m)
Speedstack calculates insertion loss over a frequency range. All frequency parameters are in Hz	
<FD_FrequencyMin>	Numeric. Hz
<FD_FrequencyMax>	Numeric. Hz
<FD_FrequencySteps>	Numeric integer. Number of frequency data points to be calculated between Min and Max
<FD_FrequencyOfInterest>	Numeric. Hz
<FD_ResultPresentation>	<p>Numeric. Result presentation of frequency dependent calculation. The mapping is as follows:</p> <p>0=per length of line (/LL)</p> <p>1=per inch (/in)</p> <p>2=per metre (/m)</p>
Extended Substrate Data causal extrapolation reference points. See page 96 of the Speedstack manual for further info. All XML elements are included regardless of structure type, only substrates used by the structure will impact on the calculation result	
<FD_ESD_SetRefPointsFromStackup_Er>	<p>Boolean. Controls the 'Set Dielectric Constant (Er) values from Stack Up materials' checkbox. Setting this value to True auto-populates the Ref Er column, False allows the user to key in the value(s)</p>

<FD_ESD_SetRefPointsFromStackup_TanD>	Boolean. Controls the 'Set Loss Tangent (TanD) values from Stack Up materials' checkbox. Setting this value to True auto-populates the Ref TanD column, False allows the user to key in the value(s)
<FD_ESD_H1RefFreq>	Numeric. Hz
<FD_ESD_H1RefEr>	Numeric. Dielectric constant
<FD_ESD_H1RefTanD>	Numeric. Loss tangent
<FD_ESD_H2RefFreq>	Numeric. Hz
<FD_ESD_H2RefEr>	Numeric. Dielectric constant
<FD_ESD_H2RefTanD>	Numeric. Loss tangent
<FD_ESD_H3RefFreq>	Numeric. Hz
<FD_ESD_H3RefEr>	Numeric. Dielectric constant
<FD_ESD_H3RefTanD>	Numeric. Loss tangent
<FD_ESD_H4RefFreq>	Numeric. Hz
<FD_ESD_H4RefEr>	Numeric. Dielectric constant
<FD_ESD_H4RefTanD>	Numeric. Loss tangent
<FD_ESD_RErRefFreq>	Numeric. Hz
<FD_ESD_RErRefEr>	Numeric. Dielectric constant
<FD_ESD_RErRefTanD>	Numeric. Loss tangent
<FD_ESD_CErRefFreq>	Numeric. Hz
<FD_ESD_CErRefEr>	Numeric. Dielectric constant
<FD_ESD_CErRefTanD>	Numeric. Loss tangent

<p>Surface Roughness Compensation. See pages 96 – 98 of the Speedstack manual for further info. All XML elements are included regardless of structure type, only roughness surfaces used by the structure will impact on the calculation result</p>	
<p><FD_SRC_Model></p>	<p>Numeric. The mapping is as follows: 0=Smooth 1=Hammerstad 2=Groisse 3=Huray 5=Gradient</p>
<p><FD_SRC_RMS_R1></p>	<p>Numeric. Surface 1 roughness RMS value in current units for Hammerstad / Groisse / Gradient model</p>
<p><FD_SRC_RMS_R2></p>	<p>Numeric. Surface 2 roughness RMS value in current units for Hammerstad / Groisse / Gradient model</p>
<p><FD_SRC_RMS_R3></p>	<p>Numeric. Surface 3 roughness RMS value in current units for Hammerstad / Groisse / Gradient model</p>
<p><FD_SRC_RMS_R4></p>	<p>Numeric. Surface 4 roughness RMS value in current units for Hammerstad / Groisse / Gradient model</p>
<p><FD_SRC_RMS_R5></p>	<p>Numeric. Surface 5 roughness RMS value in current units for Hammerstad / Groisse / Gradient model</p>
<p><FD_SRC_RMS_R6></p>	<p>Numeric. Surface 6 roughness RMS value in current units for Hammerstad / Groisse / Gradient model</p>
<p><FD_SRC_Huray_RatioOfAreas></p>	<p>Numeric.</p>
<p><FD_SRC_Huray_EffectiveBallRadius></p>	<p>Numeric. Must be in microns (µm)</p>
<p><FD_SRC_Huray_NumberOfBallsInArea></p>	<p>Numeric.</p>
<p><FD_SRC_Huray_AreaOfBallCount></p>	<p>Numeric. Area must be square microns (sq µm)</p>

<FD_SRC_Huray_EnableCannonballHuray>	Boolean. Determines whether Cannonball-Huray mode is enabled
<FD_SRC_Huray_RzMatte>	Numeric. Must be in microns (μm)
<FD_SRC_Huray_RzDrum>	Numeric. Must be in microns (μm)
<FD_IncludeOnReport>	Boolean. Controls the 'Include Loss Graph for this structure on the report' checkbox. Setting this value to True allows the user to nominate which structures will contain a separate loss graph page
<FD_LossBudget>	Numeric. As shown on the All Losses plot (dB)

Impedance Structure Guidance

Impedance structures must be placed appropriately on the defined sub-stack.

When specifying <UpperSignalLayer> and <LowerSignalLayer> they must be placed on electrical layers where the <LayerType> is defined as "signal" or "mixed".

When specifying <UpperPlaneLayer> and <LowerPlaneLayer> they must be placed on electrical layers where the <LayerType> is defined as "plane", "mixed" or "hatched".

Often impedance structures do not require all parameters. Unused parameters fields should be set to 0.

The impedance calculation engine supplied with Speedstack contains 108 transmission line structures. Explaining every structure is beyond the scope of this document, but details of the most commonly used impedance structures are given below. Please contact polarcare@polarinstruments.com if you require information on other structures

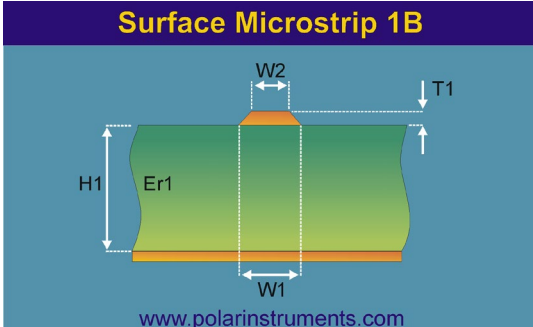
Surface Microstrip Structures	
<p>Name: Surface Microstrip 1B</p> <p>Number: 11</p> <p>Type: Single Ended</p> <p>Usage: Used on outer layers of a stackup when no solder mask is present</p>	 <p>The diagram illustrates a cross-section of a surface microstrip structure. It shows a substrate with a dielectric constant $Er1$ and a thickness $H1$. A microstrip of width $W1$ is formed on the top surface of the substrate. The microstrip has a thickness $T1$ and a top width $W2$. The diagram is titled "Surface Microstrip 1B" and includes the website "www.polarinstruments.com" at the bottom.</p>

<p>Name: Edge Coupled Surface Microstrip 1B</p> <p>Number: 111</p> <p>Type: Differential</p> <p>Usage: Used on outer layers of a stackup when no solder mask is present</p>	
---	--

Coated Microstrip Structures

<p>Name: Coated Microstrip 1B</p> <p>Number: 51</p> <p>Type: Single Ended</p> <p>Usage: Used on outer layers of a stackup when solder mask is present</p>	
---	--

<p>Name: Edge Coupled Coated Microstrip 1B</p> <p>Number: 151</p> <p>Type: Differential</p> <p>Usage: Used on outer layers of a stackup when solder mask is present</p>	
---	--

Embedded Microstrip Structures

<p>Name: Embedded Microstrip 1B1A</p> <p>Number: 22</p> <p>Type: Single Ended</p> <p>Usage: Used on inner layers of a stackup when no reference plane exists between the impedance signal layer and the surface</p>	
---	--

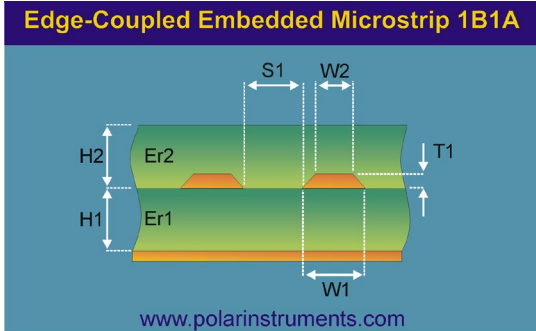
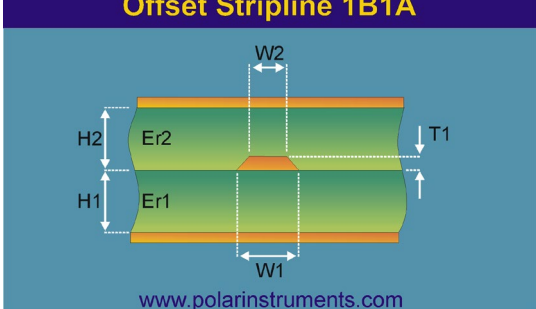
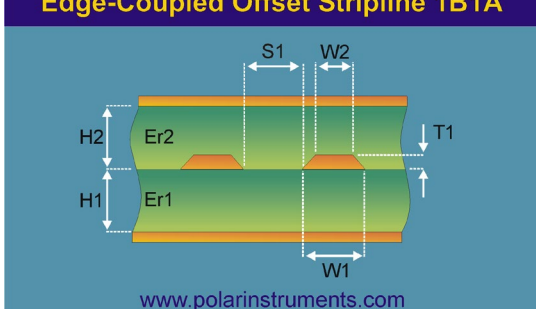
<p>Name: Edge Coupled Embedded Microstrip 1B1A</p> <p>Number: 122</p> <p>Type: Differential</p> <p>Usage: Used on inner layers of a stackup when no reference plane exists between the impedance signal layer and the surface</p>	 <p>The diagram shows a cross-section of a PCB stackup with two dielectric layers, Er1 (bottom) and Er2 (top). Two microstrip lines are embedded in the Er2 layer, separated by a distance S1. The width of the top microstrip is W2, and the width of the bottom microstrip is W1. The thickness of the Er2 layer is H2, and the thickness of the Er1 layer is H1. A reference plane is shown at the top surface of the Er2 layer, with a thickness T1. The diagram is titled "Edge-Coupled Embedded Microstrip 1B1A" and includes the website www.polarinstruments.com.</p>
<p>Offset Stripline Structures</p>	
<p>Name: Offset Stripline 1B1A</p> <p>Number: 32</p> <p>Type: Single Ended</p> <p>Usage: Used on inner layers of a stackup when a reference plane exists above and below the impedance signal layer</p>	 <p>The diagram shows a cross-section of a PCB stackup with two dielectric layers, Er1 (bottom) and Er2 (top). A single microstrip line is embedded in the Er2 layer. The width of the microstrip is W2. The thickness of the Er2 layer is H2, and the thickness of the Er1 layer is H1. A reference plane is shown at the top surface of the Er2 layer, with a thickness T1. The diagram is titled "Offset Stripline 1B1A" and includes the website www.polarinstruments.com.</p>
<p>Name: Edge Coupled Offset Stripline 1B1A</p> <p>Number: 132</p> <p>Type: Differential</p> <p>Usage: Used on inner layers of a stackup when a reference plane exists above and below the impedance signal layer</p>	 <p>The diagram shows a cross-section of a PCB stackup with two dielectric layers, Er1 (bottom) and Er2 (top). Two offset microstrip lines are embedded in the Er2 layer, separated by a distance S1. The width of the top microstrip is W2, and the width of the bottom microstrip is W1. The thickness of the Er2 layer is H2, and the thickness of the Er1 layer is H1. A reference plane is shown at the top surface of the Er2 layer, with a thickness T1. The diagram is titled "Edge-Coupled Offset Stripline 1B1A" and includes the website www.polarinstruments.com.</p>